

---

# QuickTime File Format Specification



2007-09-04



Apple Inc.  
© 2004, 2007 Apple Inc.  
All rights reserved.

No part of this publication may be reproduced, stored in a retrieval system, or transmitted, in any form or by any means, mechanical, electronic, photocopying, recording, or otherwise, without prior written permission of Apple Inc., with the following exceptions: Any person is hereby authorized to store documentation on a single computer for personal use only and to print copies of documentation for personal use provided that the documentation contains Apple's copyright notice.

The Apple logo is a trademark of Apple Inc.

Use of the "keyboard" Apple logo (Option-Shift-K) for commercial purposes without the prior written consent of Apple may constitute trademark infringement and unfair competition in violation of federal and state laws.

No licenses, express or implied, are granted with respect to any of the technology described in this document. Apple retains all intellectual property rights associated with the technology described in this document. This document is intended to assist application developers to develop applications only for Apple-labeled or Apple-licensed computers.

Every effort has been made to ensure that the information in this document is accurate. Apple is not responsible for typographical errors.

Apple Inc.  
1 Infinite Loop  
Cupertino, CA 95014  
408-996-1010

Apple, the Apple logo, Chicago, ColorSync, Mac, Mac OS, Macintosh, QuickDraw, and QuickTime are trademarks of Apple Inc., registered in the United States and other countries.

Aperture is a trademark of Apple Inc.

Intel and Intel Core are registered trademarks of Intel Corporation or its subsidiaries in the United States and other countries.

Java and all Java-based trademarks are trademarks or registered trademarks of Sun Microsystems, Inc. in the U.S. and other countries.

PowerPC and the PowerPC logo are trademarks of International Business Machines Corporation, used under license therefrom.

Simultaneously published in the United States and Canada.

**Even though Apple has reviewed this document, APPLE MAKES NO WARRANTY OR REPRESENTATION, EITHER EXPRESS OR IMPLIED, WITH RESPECT TO THIS DOCUMENT, ITS QUALITY, ACCURACY, MERCHANTABILITY, OR FITNESS FOR A PARTICULAR PURPOSE. AS A RESULT, THIS DOCUMENT IS PROVIDED "AS IS," AND YOU, THE READER, ARE ASSUMING THE ENTIRE RISK AS TO ITS QUALITY AND ACCURACY.**

**IN NO EVENT WILL APPLE BE LIABLE FOR DIRECT, INDIRECT, SPECIAL, INCIDENTAL, OR CONSEQUENTIAL DAMAGES RESULTING FROM ANY DEFECT OR INACCURACY IN THIS DOCUMENT, even if advised of the possibility of such damages.**

**THE WARRANTY AND REMEDIES SET FORTH ABOVE ARE EXCLUSIVE AND IN LIEU OF ALL OTHERS, ORAL OR WRITTEN, EXPRESS OR IMPLIED. No Apple dealer, agent, or employee is authorized to make any modification, extension, or addition to this warranty.**

**Some states do not allow the exclusion or limitation of implied warranties or liability for incidental or consequential damages, so the above limitation or exclusion may not apply to you. This warranty gives you specific legal rights, and you may also have other rights which vary from state to state.**

# Contents

## **Introduction**      **Introduction to QuickTime File Format Specification** 15

---

- Organization of This Document 16
- Licensing Information 16
- Special Fonts 16
- Updates to This Specification 16
- For More Information 17

## **Chapter 1**      **Overview of QTFF** 19

---

- Metadata 19
- Atoms 19
  - Atom Layout 20
  - Atom Structure 21
- QT Atoms and Atom Containers 23
  - QT Atom Containers 25
- QuickTime Movie Files 27
  - The File Type Compatibility Atom 30
  - Free Space Atoms 31
  - Movie Data Atoms 31
  - Preview Atoms 32

## **Chapter 2**      **Movie Atoms** 33

---

- Overview of Movie Atoms 34
  - The Movie Atom 35
  - The Movie Profile Atom 37
  - Movie Header Atoms 38
  - Color Table Atoms 41
  - User Data Atoms 42
- Track Atoms 46
  - Track Profile Atom 48
  - Track Header Atoms 48
  - Clipping Atoms 51
  - Clipping Region Atoms 52
  - Track Matte Atoms 52
  - Compressed Matte Atoms 53
  - Edit Atoms 54

Edit List Atoms	55
Track Load Settings Atoms	56
Track Reference Atoms	57
Track Input Map Atoms	59
Media Atoms	62
Media Header Atoms	63
Handler Reference Atoms	65
Media Information Atoms	66
Video Media Information Atoms	67
Video Media Information Header Atoms	67
Sound Media Information Atoms	68
Sound Media Information Header Atoms	69
Base Media Information Atoms	70
Base Media Information Header Atoms	71
Base Media Info Atoms	71
Data Information Atoms	73
Data Reference Atoms	74
Sample Atoms	75
Sample Table Atoms	76
Sample Description Atoms	78
Time-to-Sample Atoms	79
Sync Sample Atoms	81
Sample-to-Chunk Atoms	83
Sample Size Atoms	84
Chunk Offset Atoms	86
Using Sample Atoms	87
Compressed Movie Resources	88
Allowing QuickTime to Compress the Movie Resource	89
Structure of a Compressed Movie Resource	89
Reference Movies	89
Reference Movie Atom	91
Reference Movie Descriptor Atom	91
Data Reference Atom	92
Data Rate Atom	93
CPU Speed Atom	94
Version Check Atom	94
Component Detect Atom	95
Constants	96
Quality Atom	97

### Chapter 3      Media Data Atom Types 99

---

Video Media	100
Video Sample Description	100
Video Sample Data	112
Sound Media	117

Sound Sample Descriptions	117
Sound Sample Data	124
Timecode Media	126
Timecode Sample Description	126
Timecode Media Information Atom	127
Text Media	129
Text Sample Description	129
Text Sample Data	131
Hypertext and Wired Text	132
Music Media	133
Music Sample Description	133
Music Sample Data	133
MPEG-1 Media	134
MPEG-1 Sample Description	134
MPEG-1 Sample Data	134
Sprite Media	134
Sprite Sample Description	134
Sprite Sample Data	134
Sprite Track Properties	136
Sprite Track Media Format	137
Sprite Media Format Atoms	139
Sprite Media Format Extensions	139
Sprite Track Property Atoms	139
Atom Types	140
Sprite Button Behaviors	144
QT Atom Container Description Key	145
Sprite Media Handler Track Properties QT Atom Container Format	146
Sprite Media Handler Sample QT Atom Container Formats	146
Wired Action Grammar	147
Flash Media	153
Tween Media	153
Tween Sample Description	154
Tween Sample Data	154
Tween Type Categories	155
Tween QT Atom Container	156
Modifier Tracks	163
Limitations of Spatial Modifier Tracks	163
Track References	164
Chapter Lists	164
3D Media	165
3D Sample Description	165
3D Sample Data	165
Streaming Media	165
Streaming Media Sample Description	165
Hint Media	166
Adding Hint Tracks to a Movie	167

Packetization Hint Media Header Atom	168
Hint Track User Data Atom	168
Movie Hint Info Atom	168
Finding an Original Media Track From a Hint Track	170
RTP Hint Tracks	170
Hint Sample Data Format	171
Packetization Hint Sample Data for Data Format 'rtp'	173
No-Op Data Mode	177
Immediate Data Mode	177
Sample Mode	177
Sample Description Mode	179
VR Media	180
VR World Atom Container	181
Node Parent Atom	185
Node Location Atom Structure	185
Custom Cursor Atoms	186
Node Information Atom Container	186
Node Header Atom Structure	187
Hot Spot Parent Atom	188
Hot Spot Information Atom	188
Specific Information Atoms	190
Link Hot Spot Atom	190
URL Hot Spot Atom	192
Support for Wired Actions	192
QuickTime VR File Format	193
Single-Node Panoramic Movies	194
Single-Node Object Movies	195
Multinode Movies	196
QTVR Track	196
QuickTime VR Sample Description Structure	197
Panorama Tracks	197
Panorama Sample Atom Structure	198
Panorama Image Track	201
Cylindrical Panoramas	202
Cubic Panoramas	203
Image Tracks in Cubic Nodes	203
Panorama Tracks in Cubic Nodes	204
Nonstandard Cubes	205
Hot Spot Image Tracks	206
Low-Resolution Image Tracks	206
Track Reference Entry Structure	206
Object Tracks	207
Object Sample Atom Structure	207
Track References for Object Tracks	212
Movie Media	213
Movie Sample Description	213

Movie Media Sample Format 213

## Chapter 4 Basic Data Types 219

---

Language Code Values 219  
     Macintosh Language Codes 219  
     ISO Language Codes 222  
 Calendar Date and Time Values 222  
 Matrices 222  
 Graphics Modes 223  
 RGB Colors 224  
 Balance 224

## Chapter 5 Some Useful Examples and Scenarios 225

---

Creating, Copying, and Disposing of Atom Containers 226  
     Creating New Atoms 226  
     Copying Existing Atoms 228  
     Retrieving Atoms From an Atom Container 229  
     Modifying Atoms 231  
     Removing Atoms From an Atom Container 232  
 Creating an Effect Description 233  
     Structure of an Effect Description 233  
     Required Atoms of an Effects Description 233  
     Parameter Atoms of an Effects Description 234  
     Creating an Input Map 235  
 Creating Movies with Modifier Tracks 238  
 Authoring Movies with External Movie Targets 239  
     Target Atoms for Embedded Movies 240  
 Adding Wired Actions To a Flash Track 240  
     Extending the SWF Format 241  
 Creating Video Tracks at 30 Frames per Second 243  
 Creating Video Tracks at 29.97 Frames per Second 243  
 Creating Audio Tracks at 44.1 kHz 244  
 Creating a Timecode Track for 29.97 FPS Video 244  
 Playing with Edit Lists 248  
 Interleaving Movie Data 250  
 Referencing Two Data Files With a Single Track 251  
 Getting the Name of a QuickTime VR Node 252  
 Adding Custom Atoms in a QuickTime VR Movie 254  
 Adding Atom Containers in a QuickTime VR Movie 255  
 Optimizing QuickTime VR Movies for Web Playback 256  
     The QTVR Flattener 256  
     Sample Atom Container for the QTVR Flattener 257

**Appendix A**      [QuickTime Image File Format](#) 259

---

[Atom Types in QuickTime Image Files](#) 259  
[Recommended File Type and Suffix](#) 261

**Appendix B**      [Defining Media Data Layouts](#) 263

---

[Using QuickTime Files and Media Layouts](#) 263

**Appendix C**      [Random Access](#) 265

---

[Seeking With a QuickTime File](#) 265

**Appendix D**      [Metadata Handling](#) 267

---

[Digital Video File Formats](#) 267  
[Digital Audio File Formats](#) 268  
[Still Image File Formats](#) 269  
[Animation and 3D File Formats](#) 270

**Appendix E**      [Summary of VR World and Node Atom Types](#) 273

---

[C Summary](#) 273  
     [Constants](#) 273  
     [Data Types](#) 275

**Appendix F**      [Profile Atom Guidelines](#) 281

---

[About This Appendix](#) 281  
[Profile Atom Specification](#) 282  
     [Definition](#) 282  
     [Syntax](#) 283  
     [Semantics](#) 284  
[Universal Features](#) 284  
     [Table of Features](#) 285  
     [Maximum Video Bitrate](#) 286  
     [Average Video Bitrate](#) 287  
     [Maximum Audio Bitrate](#) 288  
     [Average Audio Bitrate](#) 289  
     [QuickTime Video Codec Type](#) 290  
     [QuickTime Audio Codec Type](#) 291  
     [MPEG-4 Video Profile](#) 292  
     [MPEG-4 Video Codec](#) 293  
     [MPEG-4 Video Object Type](#) 294  
     [MPEG-4 Audio Codec](#) 295  
     [Maximum Video Size in a Movie](#) 296



Maximum Video Size in a Track 298  
Maximum Video Frame Rate in a Single Track 299  
Average Video Frame Rate in a Single Track 300  
Video Variable Frame Rate Indication 301  
Audio Sample Rate for a Sample Entry 302  
Audio Variable Bitrate Indication 303  
Audio Channel Count 304

Document Revision History 305

---

Glossary 307

---

C O N T E N T S

# Figures, Tables, and Listings

## Chapter 1 Overview of QTFF 19

---

Figure 1-1	A sample atom	21
Figure 1-2	Calculating atom sizes	23
Figure 1-3	QT atom layout	24
Figure 1-4	QT atom container with parent and child atoms	25
Figure 1-5	A QT atom container with two child atoms	26
Figure 1-6	The structure of a QuickTime movie file	29
Figure 1-7	The layout of a preview atom	32
Table 1-1	Basic atom types of a QuickTime file	29

## Chapter 2 Movie Atoms 33

---

Figure 2-1	Sample organization of a one-track video movie	35
Figure 2-2	The layout of a movie atom	36
Figure 2-3	The layout of a movie header atom	39
Figure 2-4	The layout of a color table atom	41
Figure 2-5	The layout of a user data atom	42
Figure 2-6	The layout of a track atom	47
Figure 2-7	The layout of a track header atom	49
Figure 2-8	The layout of a clipping atom	51
Figure 2-9	The layout of a track matte atom	53
Figure 2-10	The layout of an edit atom	54
Figure 2-11	The layout of an edit list table entry	55
Figure 2-12	The layout of a track load settings atom	56
Figure 2-13	The layout of a track reference atom	58
Figure 2-14	The layout of a track input map atom	60
Figure 2-15	The layout of a media atom	63
Figure 2-16	The layout of a media header atom	64
Figure 2-17	The layout of a handler reference atom	65
Figure 2-18	The layout of a media information atom for video	67
Figure 2-19	The layout of a media information header atom for video	68
Figure 2-20	The layout of a media information atom for sound	69
Figure 2-21	The layout of a sound media information header atom	70
Figure 2-22	The layout of a base media information atom	71
Figure 2-23	The layout of a base media info atom	72
Figure 2-24	The layout of a data information atom	73
Figure 2-25	Samples in a media	76

Figure 2-26	The layout of a sample table atom	77
Figure 2-27	The layout of a sample description atom	78
Figure 2-28	The layout of a time-to-sample atom	80
Figure 2-29	The layout of a time-to-sample table entry	80
Figure 2-30	An example of a time-to-sample table	81
Figure 2-31	The layout of a sync sample atom	82
Figure 2-32	The layout of a sync sample table	82
Figure 2-33	The layout of a sample-to-chunk atom	83
Figure 2-34	The layout of a sample-to-chunk table entry	84
Figure 2-35	An example of a sample-to-chunk table	84
Figure 2-36	The layout of a sample size atom	85
Figure 2-37	An example of a sample size table	86
Figure 2-38	The layout of a chunk offset atom	86
Figure 2-39	An example of a chunk offset table	87
Figure 2-40	A movie atom containing a 'rmra' atom instead of a 'mvhd' atom	90
Figure 2-41	A 'rmra' atom with multiple 'rmda' atoms	91
Figure 2-42	Reference movie descriptor atom	92
Table 2-1	User data list entry types	43
Table 2-2	Track reference types	58
Table 2-3	Input types	61
Table 2-4	Data reference types	75
Table 2-5	Contents of complete compressed movie	89

**Chapter 3**      **Media Data Atom Types** 99

---

Figure 3-1	Color atom	105
Figure 3-2	Transfer between RGB and YCbCr color spaces	106
Figure 3-3	The normalized values are shown using the symbol E with a subscript for Y, Cb, or Cr:	107
Figure 3-4	Equations for stored YCbCr v alues of bit-depth of n in scheme A	107
Figure 3-5	Equations for stored YCbCr v alues of bit-depth n in scheme B	108
Figure 3-6	Equations for index code 1	109
Figure 3-7	Equations for index code 7	109
Figure 3-8	Matrix values for index code 1	110
Figure 3-9	Matrix values for index code 6	110
Figure 3-10	Matrix values for index code 7	110
Figure 3-11	Motion-JPEG A dual-field sample data	114
Figure 3-12	Motion-JPEG B dual-field sample data	116
Figure 3-13	A key frame sample atom container	137
Figure 3-14	Atoms that describe a sprite and its properties	138
Figure 3-15	Atoms that describe sprite images	138
Figure 3-16	Structure of the VR world atom container	182
Figure 3-17	Structure of the node information atom container	187
Figure 3-18	The structure of a single-node panoramic movie file	194
Figure 3-19	The structure of a single-node object movie file	195
Figure 3-20	The structure of a multinode movie file	196

Figure 3-21	Creating an image track for a panorama	201
Figure 3-22	Creating an image track for a panorama, with the image track oriented horizontally	202
Figure 3-23	The structure of an image track for an object	213
Table 3-1	Some image compression formats	100
Table 3-2	Video sample description extensions	102
Table 3-3	Common pixel aspect ratios	104
Table 3-4	Table of primaries, index and values	108
Table 3-5	Table of transfer function index and values	109
Table 3-6	Table of matrix index and values	110
Table 3-7	Partial list of supported QuickTime audio formats.	118
Table 3-8	Text sample extensions	132
Table 3-9	Sprite properties	135
Table 3-10	Sprite track properties	136
Table 3-11	Tween type values	154
Table 3-12	The 'hinf' atom type containing child atoms	169
Table 3-13	Hint track sample description	171
Table 3-14	The structure of table entries	172
Table 3-15	Fields and their special values as represented in the pano sample data atom, providing backward compatibility to QuickTime VR 2.2	204
Table 3-16	Values for min and max fields	205
Table 3-17	Values used for representing six square sides	205
Listing 3-1	Streaming media sample description	166

**Chapter 4**      **Basic Data Types**    219

---

Figure 4-1	How display matrices are used in QuickTime	223
Figure 4-2	Applying the transform	223
Table 4-1	QuickTime language code values	219
Table 4-2	5-bit values of UTF-8 characters	222
Table 4-3	QuickTime graphics modes	224

**Chapter 5**      **Some Useful Examples and Scenarios**    225

---

Figure 5-1	QT atom container after inserting an atom	227
Figure 5-2	QT atom container after inserting a second atom	227
Figure 5-3	Two QT atom containers, A and B	228
Figure 5-4	QT atom container after child atoms have been inserted	229
Figure 5-5	An example effect description for the Push effect	235
Figure 5-6	An example of an input map referencing two sources	237
Figure 5-7	Non-interleaved movie data	250
Figure 5-8	Interleaved movie data	250
Listing 5-1	Creating a new atom container	226
Listing 5-2	Disposing of an atom container	226
Listing 5-3	Creating a new QT atom container and calling QTInsertChild to add an atom.	226

Listing 5-4	Inserting a child atom	227
Listing 5-5	Inserting a container into another container	229
Listing 5-6	Finding a child atom by index	230
Listing 5-7	Finding a child atom by ID	230
Listing 5-8	Modifying an atom's data	231
Listing 5-9	Removing atoms from a container	232
Listing 5-10	Adding a <code>kParameterWhatName</code> atom to the atom container <code>effectDescription</code>	234
Listing 5-11	Adding an input reference atom to an input map	237
Listing 5-12	Linking a modifier track to the track it modifies	238
Listing 5-13	Updating the input map	238
Listing 5-14	Getting a node's name	252
Listing 5-15	Typical hot spot intercept procedure	254
Listing 5-16	Adding atom containers to a track	255
Listing 5-17	Using the flattener	256
Listing 5-18	Specifying a preview file for the flattener to use	257
Listing 5-19	Overriding the compression settings	258

**Appendix A**      **QuickTime Image File Format**    259

---

Figure A-1	An 'idsc' atom followed by an 'idat' atom	259
Table A-1	A QuickTime image file containing JPEG-compressed data	260

**Appendix F**      **Profile Atom Guidelines**    281

---

Figure F-1	The profile atom	283
Figure F-2	Layout of a typical feature	284
Table F-1	Universal features	285

# Introduction to QuickTime File Format Specification

---

The QuickTime File Format (QTFF) is designed to accommodate the many kinds of data that need to be stored in order to work with digital multimedia. The QTFF is an ideal format for the exchange of digital media between devices, applications, and operating systems because it can be used to describe almost any media structure.

The file format is object-oriented, consisting of a flexible collection of objects that is easily parsed and easily expanded. Unknown objects can simply be ignored or skipped, allowing considerable forward compatibility as new object types are introduced.

QuickTime itself provides a number of high-level functions that you can use to create and manipulate QuickTime files, without requiring you to understand the actual file format. These functions serve to insulate developers from the low-level details of operation. That said, not all kinds of QuickTime files can be created without the information presented here.

**Important:** The QuickTime File Format has been used as the basis of the MPEG-4 standard and the JPEG-2000 standard, developed by the International Organization for Standardization (ISO). While these file types have similar structures and contain many functionally identical elements, they are distinct file types.



**Warning:** Do not use one specification to interpret a file that conforms to a different specification, however similar.

The *QuickTime File Format Specification* is intended primarily for application developers who need to work with QuickTime files outside the context of the QuickTime environment. For example, if you are developing a non-QuickTime application that imports QuickTime files or works with QuickTime VR, you need to understand the material in this document. By reading the information provided here, you should be able to create appropriate data structure specifications for your environment.

The document assumes that you are familiar with the basic concepts of digital video and audio, as well as with programming QuickTime and the QuickTime API. Note that this iteration of the document supersedes all previous versions of the *QuickTime File Format Specification*.

## Organization of This Document

---

This document begins with an overview of QuickTime atoms, then presents the structure of the QuickTime file format in detail. This is followed by a series of code examples for manipulating a QuickTime file using the QuickTime API. Finally, a number of related topics are described in a series of appendixes. These include such topics as the QuickTime Image File format, the handling of metadata when importing files into QuickTime, and details of the profile atom.

QuickTime files are described in general, rather than how they are supported on a specific computing platform or in a specific programming language. As a result, the file format information is presented in a tabular manner, rather than in coded data structures. Similarly, field names are presented in English rather than as programming language tags. Furthermore, to the extent possible, data types are described generically. For example, this book uses “32-bit signed integer” rather than “long” to define a 32-bit integer value.

QuickTime files are used to store QuickTime movies, as well as other data. If you are writing an application that parses QuickTime files, you should recognize that there may be non-movie data in the files.

## Licensing Information

---

The *QuickTime File Format Specification* is provided for informational purposes. Apple may have patents, patent applications, trademarks, copyrights, or other intellectual property rights covering subject matter in this document. The furnishing of this document does not give you a license to any patents, trademarks, copyrights, or other intellectual property.

**Important:** For more information about licensing the QuickTime File Format, contact: Apple, Inc., Software Licensing Department, 12545 Riata Vista Circle, MS 198 3-SWL, Austin, TX 78727. Email Address: [sw.license@apple.com](mailto:sw.license@apple.com)

## Special Fonts

---

All code listings, reserved words, and the names of actual data structures, constants, fields, parameters, and routines are shown in Letter Gothic (this is Letter Gothic).

Words that appear in boldface are key terms or concepts and are defined in the glossary.

## Updates to This Specification

---

For updates or changes to this specification, go to the QuickTime documentation site at

[QuickTime Reference Library](#)



and click the [File Format Specification](#) link.

## For More Information

---

For information about membership in Apple's developer program and developer technical support, you should go to this URL:

[Apple Developer Connection](#)

For information on registering signatures, file types, and other technical information, contact

Apple Developer Technical Support (DTS)  
Apple, Inc.  
1 Infinite Loop, M/S 303-2T  
Cupertino, CA 95014

# I N T R O D U C T I O N

## Introduction to QuickTime File Format Specification

# Overview of QTFF

---

QuickTime movies are stored on disk, using two basic structures for storing information: atoms (also known as simple atoms or classic atoms), and QT atoms. To understand how QuickTime movies are stored, you need to understand the basic atom structures described in this chapter. Most atoms you encounter in the QuickTime File Format are simple or classic atoms. Both simple atoms and QT atoms, however, allow you to construct arbitrarily complex hierarchical data structures. Both also allow your application to ignore data they don't understand.

## Metadata

---

A QuickTime file stores the description of its media separately from the media data. The description, or **metadata**, is called the movie resource, movie atom, or simply the movie, and contains information such as the number of tracks, the video compression format, and timing information. The movie resource also contains an index describing where all the media data is stored.

The media data is the actual sample data, such as video frames and audio samples, used in the movie. The media data may be stored in the same file as the QuickTime movie, in a separate file, in multiple files, in alternate sources such as databases or real-time streams, or in some combination of these.

## Atoms

---

The basic data unit in a QuickTime file is the atom. Each atom contains size and type fields that precede any other data. The size field indicates the total number of bytes in the atom, including the size and type fields. The type field specifies the type of data stored in the atom and, by implication, the format of that data. In some cases, the size and type fields are followed by a version field and a flags field. An atom with these version and flags fields is sometimes called a **full atom**.

**Note:** An **atom**, as described in this document, is functionally identical to a **box**, as described in the ISO specifications for MPEG-4 and JPEG-2000. An atom that includes version and flags fields is functionally identical to a **full box** as defined in those specifications.

Atom types are specified by a 32-bit unsigned integer, typically interpreted as a four-character ASCII code. Apple, Inc. reserves all four-character codes consisting entirely of lowercase letters. Unless otherwise stated, all data in a QuickTime movie is stored in big-endian byte ordering, also known as network byte ordering, in which the most significant bytes are stored and transmitted first.

Atoms are hierarchical in nature. That is, one atom can contain other atoms, which can contain still others, and so on. This hierarchy is sometimes described in terms of a parent, children, siblings, grandchildren, and so on. An atom that contains other atoms is called a **container atom**. The **parent atom** is the container atom exactly one level above a given atom in the hierarchy.

For example, a movie atom contains several different kinds of atoms, including one track atom for each track in the movie. The track atoms, in turn, contain one media atom each, along with other atoms that define other track characteristics. The movie atom is the parent atom of the track atoms. The track atoms are siblings. The track atoms are parent atoms of the media atoms. The movie atom is *not* the parent of the media atoms, because it is more than one layer above them in the hierarchy.

An atom that does not contain other atoms is called a **leaf atom**, and typically contains data as one or more fields or tables. Some leaf atoms act as flags or placeholders, however, and contain no data beyond their size and type fields.

The format of the data stored within a given atom cannot always be determined by the type field of the atom alone; the type of the parent atom may also be significant. In other words, a given atom type can contain different kinds of information depending on its parent atom. For example, the profile atom inside a movie atom contains information about the movie, while the profile atom inside a track atom contains information about the track. This means that all QuickTime file readers must take into consideration not only the atom type, but also the atom's containment hierarchy.

## Atom Layout

---

Figure 1-1 (page 21) shows the layout of a sample atom. Each atom carries its own size and type information as well as its data. Throughout this document, the name of a container atom (an atom that contains other atoms, including other container atoms) is printed in a gray box, and the name of a leaf atom (an atom that contains no other atoms) is printed in a white box. Leaf atoms contain data, usually in the form of tables.

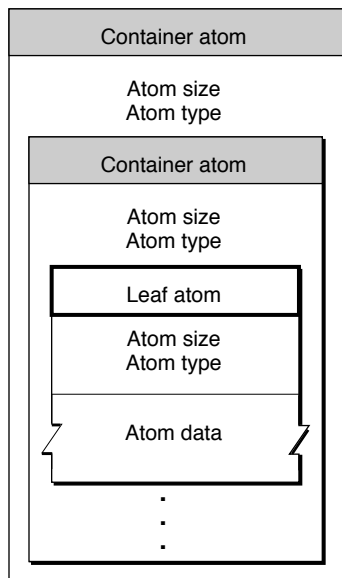
**Figure 1-1** A sample atom

A leaf atom, as shown in [Figure 1-1](#) (page 21), simply contains a series of data fields accessible by offsets.

Atoms within container atoms do not generally have to be in any particular order, unless such an order is specifically called out in this document. One such example is the handler description atom, which must come before the data being handled. For example, a media handler description atom must come before a media information atom, and a data handler description atom must come before a data information atom.

## Atom Structure

---

Atoms consist of a header, followed by atom data. The header contains the atom's size and type fields, giving the size of the atom in bytes and its type. It may also contain an extended size field, giving the size of a large atom as a 64-bit integer. If an extended size field is present, the size field is set to 1. The actual size of an atom cannot be less than 8 bytes (the minimum size of the type and size fields).

Some atoms also contain version and flags fields. These are sometimes called full atoms. The flag and version fields are not treated as part of the atom header in this document; they are treated as data fields specific to each atom type that contains them. Such fields must always be set to zero, unless otherwise specified.

An atom header consists of the following fields:

### Atom size

A 32-bit integer that indicates the size of the atom, including both the atom header and the atom's contents, including any contained atoms. Normally, the `size` field contains the actual size of the atom, in bytes, expressed as a 32-bit unsigned integer. However, the `size` field can contain special values that indicate an alternate method of determining the atom size. (These special values are normally used only for media data ('mdat') atoms.) If the `size` field is set to 0, which is allowed only for a top-level atom, this is the last atom in the file and it extends

to the end of the file. If the `size` field is set to 1, then the actual size is given in the `extended size` field, an optional 64-bit field that follows the `type` field. This accommodates media data atoms that contain more than  $2^{32}$  bytes. Figure 1-2 (page 23) shows how to calculate the size of an atom.

### Type

A 32-bit integer that contains the type of the atom. This can often be usefully treated as a four-character field with a mnemonic value, such as 'moov' (0x6D6F6F76) for a movie atom, or 'trak' (0x7472616B) for a track atom, but non-ASCII values (such as 0x00000001) are also used. Knowing an atom's type allows you to interpret its data. An atom's data can be arranged as any arbitrary collection of fields, tables, or other atoms. The data structure is specific to the atom type. An atom of a given type has a defined data structure. If your application encounters an atom of an unknown type, it should not attempt to interpret the atom's data. Use the atom's `size` field to skip this atom and all of its contents. This allows a degree of forward compatibility with extensions to the QuickTime file format.



**Warning:** The internal structure of a given type of atom can change when a new version is introduced. Always check the version field, if one exists. Never attempt to interpret data that falls outside of the atom, as defined by the `Size` or `Extended Size` fields.

### Extended Size

If the `size` field of an atom is set to 1, the `type` field is followed by a 64-bit `extended size` field, which contains the actual size of the atom as a 64-bit unsigned integer. This is used when the size of a media data atom exceeds  $2^{32}$  bytes.

When the `size` field contains the actual size of the atom, the `extended size` field is not present. This means that when a QuickTime atom is modified by adding data, and its size crosses the  $2^{32}$  byte limit, there is no `extended size` field in which to record the new atom size. Consequently, it is not always possible to enlarge an atom beyond  $2^{32}$  bytes without copying its contents to a new atom.

To prevent this inconvenience, media data atoms are typically created with a 64-bit placeholder atom immediately preceding them in the movie file. The placeholder atom has a type of `kWideAtomPlaceholderType` ('wide'). Much like a 'free' or 'skip' atom, the 'wide' atom is reserved space, but in this case the space is reserved for a specific purpose. If a 'wide' atom immediately precedes a second atom, the second atom can be extended from a 32-bit size to a 64-bit size simply by starting the atom header 8 bytes earlier (overwriting the 'wide' atom), setting the `size` field to 1, and adding an `extended size` field. This way the offsets for sample data do not need to be recalculated.

The 'wide' atom is exactly 8 bytes in size, and consists solely of its `size` and `type` fields. It contains no other data.

**Note:** A common error is thinking that the 'wide' atom contains the extended size. The 'wide' atom is merely a placeholder that can be overwritten if necessary, by an atom header containing an extended size field.

**Figure 1-2** Calculating atom sizes

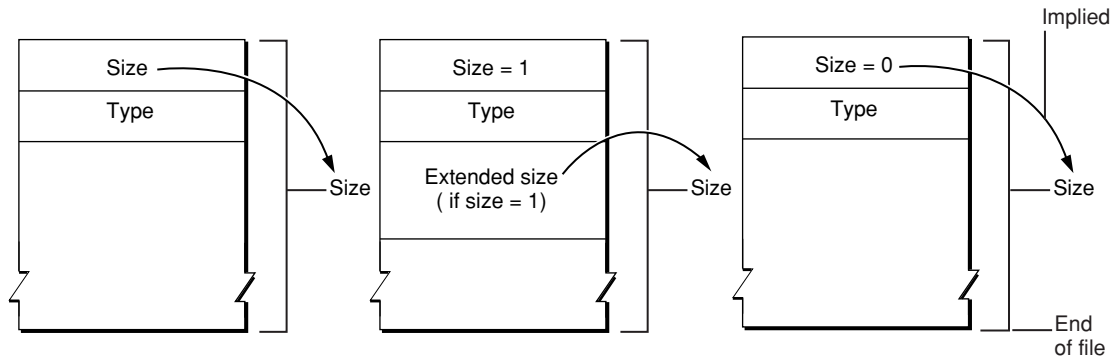

## QT Atoms and Atom Containers

QT atoms are an enhanced data structure that provide a more general-purpose storage format and remove some of the ambiguities that arise when using simple atoms. A QT atom has an expanded header; the size and type fields are followed by fields for an atom ID and a count of child atoms.

This allows multiple child atoms of the same type to be specified through identification numbers. It also makes it possible to parse the contents of a QT atom of unknown type, by walking the tree of its child atoms.

QT atoms are normally wrapped in an **atom container**, a data structure with a header containing a lock count. Each atom container contains exactly one **root** atom, which is the QT atom. Atom containers are not atoms, and are not found in the hierarchy of atoms that makes up a QuickTime movie file. Atom containers may be found as data structures inside some atoms, however. Examples include media input maps and media property atoms.

**Important:** An **atom container** is *not* the same as a **container atom**. An atom container is a *container*, not an atom.

[Figure 1-3](#) (page 24) depicts the layout of a QT atom. Each QT atom starts with a QT atom container header, followed by the root atom. The root atom's type is the QT atom's type. The root atom contains any other atoms that are part of the structure.

Each container atom starts with a QT atom header followed by the atom's contents. The contents are either child atoms or data, but never both. If an atom contains children, it also contains all of its children's data and descendants. The root atom is always present and never has any siblings.

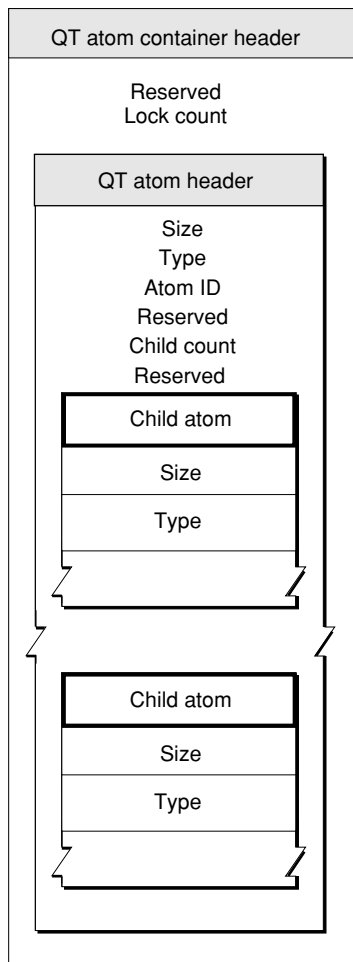
**Figure 1-3** QT atom layout

A QT atom container header contains the following data:

**Reserved**

A 10-byte element that must be set to 0.

**Lock count**

A 16-bit integer that must be set to 0.

Each QT atom header contains the following data:

**Size**

A 32-bit integer that indicates the size of the atom in bytes, including both the QT atom header and the atom's contents. If the atom is a leaf atom, then this field contains the size of the single atom. The size of container atoms includes all of the contained atoms. You can walk the atom tree using the size and child count fields.

**Type**

A 32-bit integer that contains the type of the atom. If this is the root atom, the type value is set to 'sean'.



**Atom ID**

A 32-bit integer that contains the atom's ID value. This value must be unique among its siblings. The root atom always has an atom ID value of 1.

**Reserved**

A 16-bit integer that must be set to 0.

**Child count**

A 16-bit integer that specifies the number of child atoms that an atom contains. This count only includes immediate children. If this field is set to 0, the atom is a leaf atom and only contains data.

**Reserved**

A 32-bit integer that must be set to 0.

## QT Atom Containers

---

A QuickTime atom container is a basic structure for storing information in QuickTime. An atom container is a tree-structured hierarchy of QT atoms. You can think of a newly created QT atom container as the root of a tree structure that contains no children.

An atom container is a container, not an atom. It has a reserved field and a lock count in its header, not a size field and type field. Atom containers are not found in the atom hierarchy of a QuickTime movie file, because they are not atoms. They may be found as data inside some atoms, however, such as in media input maps, media property atoms, video effects sample data, and tween sample data.

A QT atom container contains QT atoms, as shown in [Figure 1-4](#) (page 25). Each QT atom contains either data or other atoms. If a QT atom contains other atoms, it is a parent atom and the atoms it contains are its child atoms. Each parent's child atom is uniquely identified by its atom type and atom ID. A QT atom that contains data is called a leaf atom.

**Figure 1-4** QT atom container with parent and child atoms

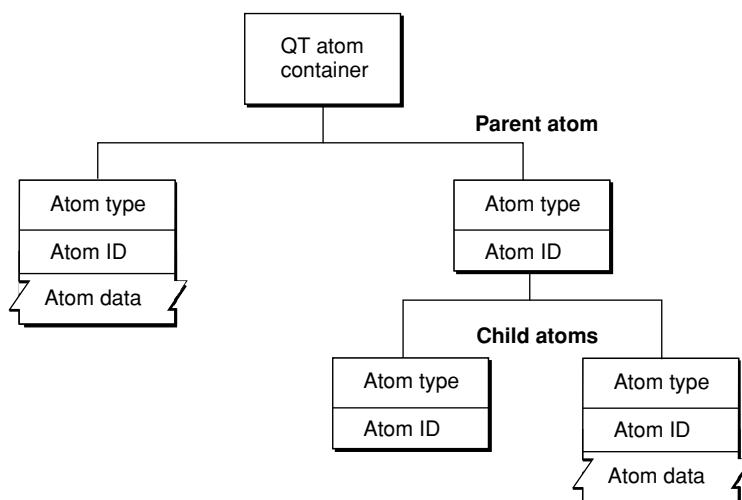

Each QT atom has an offset that describes the atom’s position within the QT atom container. In addition, each QT atom has a type and an ID. The atom type describes the kind of information the atom represents. The atom ID is used to differentiate child atoms of the same type with the same parent; an atom’s ID must be unique for a given parent and type. In addition to the atom ID, each atom has a 1-based index that describes its order relative to other child atoms of the same parent with the same atom type. You can uniquely identify a QT atom in one of three ways:

- By its offset within its QT atom container
- By its parent atom, type, and index
- By its parent atom, type, and ID

You can store and retrieve atoms in a QT atom container by index, ID, or both. For example, to use a QT atom container as a dynamic array or tree structure, you can store and retrieve atoms by index. To use a QT atom container as a database, you can store and retrieve atoms by ID. You can also create, store, and retrieve atoms using both ID and index to create an arbitrarily complex, extensible data structure.

**Warning:** Since QT atoms are offsets into a data structure, they can be changed during editing operations on QT atom containers, such as inserting or deleting atoms. For a given atom, editing child atoms is safe, but editing sibling or parent atoms invalidates that atom’s offset.

**Note:** For cross-platform purposes, all data in a QT atom is expected to be in big-endian format. However, leaf data can be little-endian if it is custom to an application.

Figure 1-5 (page 26) shows a QT atom container that has two child atoms. The first child atom (offset = 10) is a leaf atom that has an atom type of 'abcd', an ID of 1000, and an index of 1. The second child atom (offset = 20) has an atom type of 'abcd', an ID of 900, and an index of 2. Because the two child atoms have the same type, they must have different IDs. The second child atom is also a parent atom of three atoms.

**Figure 1-5** A QT atom container with two child atoms

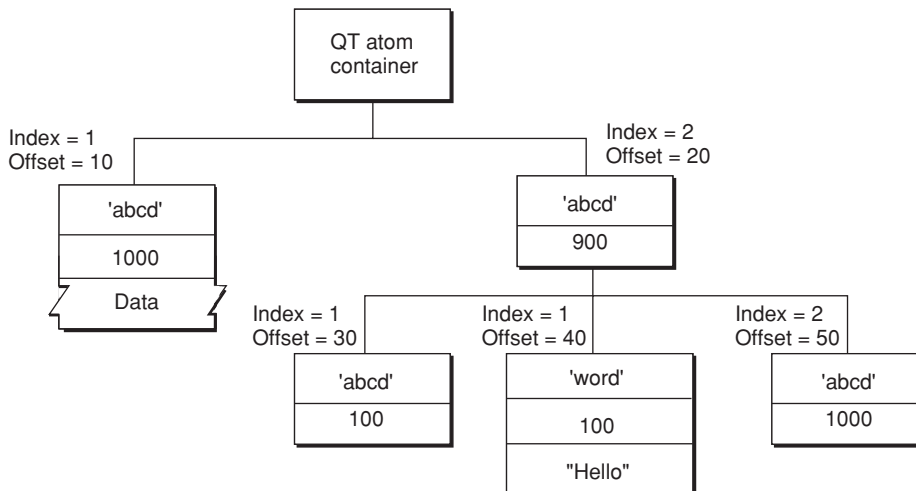

The first child atom (offset = 30) has an atom type of 'abcd', an ID of 100, and an index of 1. It does not have any children, nor does it have data. The second child atom (offset = 40) has an atom type of 'word', an ID of 100, and an index of 1. The atom has data, so it is a leaf atom. The second atom (offset = 40) has the same ID as the first atom (offset = 30), but a different atom type. The third child atom (offset = 50) has an atom type of 'abcd', an ID of 1000, and an index of 2. Its atom type and ID are the same as that of another atom (offset = 10) with a different parent.

**Note:** If you are working with the QuickTime API, you do not need to parse QT atoms. Instead, the QT atom functions can be used to create atom containers, add atoms to and remove atoms from atom containers, search for atoms in atom containers, and retrieve data from atoms in atom containers.

Most QT atom functions take two parameters to specify a particular atom: the atom container that contains the atom, and the offset of the atom in the atom container data structure. You obtain an atom's offset by calling either `QTFindChildByID` or `QTFindChildByIndex`. An atom's offset may be invalidated if the QT atom container that contains it is modified.

When calling any QT atom function for which you specify a parent atom as a parameter, you can pass the constant `kParentAtomIsContainer` as an atom offset to indicate that the specified parent atom is the atom container itself. For example, you would call the `QTFindChildByIndex` function and pass `kParentAtomIsContainer` constant for the parent atom parameter to indicate that the requested child atom is a child of the atom container itself.

## QuickTime Movie Files

---

The QuickTime file format describes the characteristics of QuickTime movie files. A QuickTime movie file contains a QuickTime movie resource, or else points to one or more external sources using movie references. The media samples used by the movie (such as video frames or groups of audio samples) may be included in the movie file, or may be external to the movie file in one or more files, streams, or other sources.

A QuickTime movie is not limited to video and audio; it may use any subset or combination of media types that QuickTime supports, including video, sound, still images, text, Flash, 3D models, and virtual reality panoramas. It supports both time-based and nonlinear interactive media.

In file systems that support filename extensions, QuickTime movie files should have an extension of `.mov`. On the Macintosh platform, QuickTime files have a Mac OS file type of `'MooV'`. QuickTime movie files should always be associated with the MIME type `"video/quicktime"`, whether or not the movie contains video.

**Note:** In file systems that support both a resource fork and a data fork, the movie resource may be contained in the resource fork. The default, however, is for the movie resource to be contained in the data fork for all file systems. If media sample data is included in the movie file, it is always in the data fork.

A QuickTime movie file is structured as a collection of atoms that together identify the file as a QuickTime movie, describe the structure of the movie, and may contain the sample data needed to play the movie. Not all atoms are required.

The file format is extensible, and from time to time new atom types are introduced. If your application encounters an unknown atom type in a QuickTime file, it should simply ignore it. This allows the file format to be extended without breaking existing applications, and provides a measure of forward compatibility. Because the first field in any atom contains its size, including any contained atoms, it is easy to skip to the end of an unknown atom type and continue parsing the file.

Generally speaking, atoms can be present in any order. Do not conclude that a particular atom is not present until you have parsed all the atoms in the file.

An exception is the file type atom, which typically identifies the file as a QuickTime movie. If present, this atom precedes any movie atom, movie data, preview, or free space atoms. If you encounter one of these other atom types prior to finding a file type atom, you may assume the file type atom is not present. (This atom is introduced in the *QuickTime File Format Specification* for 2004, and is not present in QuickTime movie files created prior to 2004).

While other atoms can be in any order, unless specified in this document, for practical reasons there is a recommended order you should use when creating a QuickTime movie file. For example, the atom containing the movie resource should precede any atoms containing the movie's sample data. If you follow this recommended atom order, it is possible to play a movie over a network while the movie file is in the process of downloading.

A QuickTime movie file must contain a movie atom, which contains either the movie structure or a reference to one or more alternate movie sources external to the file. Generally speaking, these alternate sources will be QuickTime movie files that contain movie structures.

A QuickTime movie file typically contains one or more movie data atoms, which contain media sample data such as video frames and groups of audio samples. There may be no movie data atoms in the file, however, as the movie may depend on sample data external to the movie file, such as external data files or live streams on the Internet. A single movie data atom may contain sample data for a variety of different media. Generally speaking, it is possible to contain all the media samples used by a movie in a single movie data atom. Movie data atoms can be quite large, and sometimes exceed  $2^{32}$  bytes.

[Figure 1-6](#) (page 29) shows the essential atom types in a QuickTime movie file within which other atoms are stored. In addition, the file may contain free space atoms, preview atoms, and other atoms not enumerated in this file format specification. Unknown atom types should be ignored.

**Figure 1-6** The structure of a QuickTime movie file

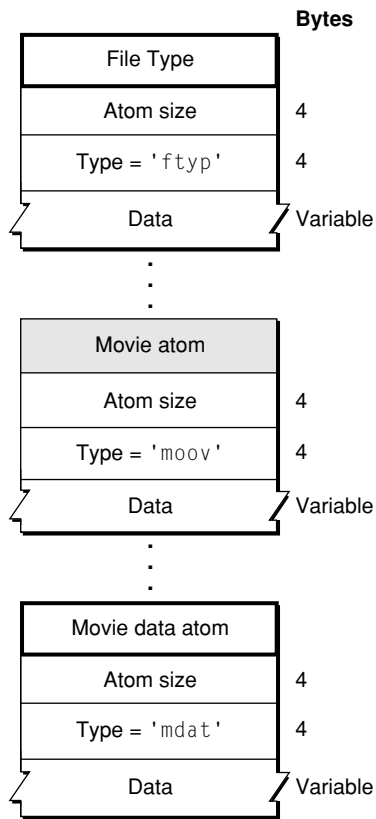

Table 1-1 (page 29) lists the basic atom types.

**Table 1-1** Basic atom types of a QuickTime file

Atom type	Use
'ftyp'	File type compatibility—identifies the file type and differentiates it from similar file types, such as MPEG-4 files and JPEG-2000 files.
'moov'	Movie resource metadata about the movie (number and type of tracks, location of sample data, and so on). Describes where the movie data can be found and how to interpret it.
'mdat'	Movie sample data—media samples such as video frames and groups of audio samples. Usually this data can be interpreted only by using the movie resource.
'free'	Unused space available in file.
'skip'	Unused space available in file.
'wide'	Reserved space—can be overwritten by an extended size field if the following atom exceeds $2^{32}$ bytes, without displacing the contents of the following atom.
'pnot'	Reference to movie preview data.

The following sections describe these basic atom types (except for the movie atom) in more detail, including descriptions of other atoms that each basic atom may contain. The movie atom is described separately in “[Movie Atoms](#)” (page 33)

## The File Type Compatibility Atom

---

The file type atom allows the reader to determine whether this is a type of file that the reader understands. Specifically, the file type atom identifies the file type specifications the file is compatible with. This allows the reader to distinguish among closely related file types, such as QuickTime movie files, MPEG-4, and JPEG-2000 files (all of which may contain file type atoms, movie atoms, and movie data atoms).

When a file is compatible with more than one specification, the file type atom lists all the compatible types and indicates the preferred brand, or best use, among the compatible types. For example, a music player using a QuickTime-compatible file format might identify a file’s best use as a music file for that player but also identify it as a QuickTime movie.

The file type atom serves a further purpose of distinguishing among different versions or specifications of the same file type, allowing it to convey more information than the file extension or MIME type alone. The file type atom also has the advantage of being internal to the file, where it is less subject to accidental alteration than a file extension or MIME type.

**Note:** The file type atom described here is functionally identical to the file type box defined in the ISO specifications for MPEG-4 and JPEG-2000.

The file type atom is optional, but strongly recommended. If present, it must be the first significant atom in the file, preceding the movie atom (and any free space atoms, preview atom, or movie data atoms).

The file type atom has an atom type value of 'ftyp' and contains the following fields:

### Size

A 32-bit unsigned integer that specifies the number of bytes in this atom.

### Type

A 32-bit unsigned integer that identifies the atom type, typically represented as a four-character code; this field must be set to 'ftyp'.

### Major\_Brand

A 32-bit unsigned integer that should be set to 'qt ' (note the two trailing ASCII space characters) for QuickTime movie files. If a file is compatible with multiple brands, all such brands are listed in the *Compatible\_Brands* fields, and the *Major\_Brand* identifies the preferred brand or best use.

### Minor\_Version

A 32-bit field that indicates the file format specification version. For QuickTime movie files, this takes the form of four binary-coded decimal values, indicating the century, year, and month of the *QuickTime File Format Specification*, followed by a binary coded decimal zero. For example, for the June 2004 minor version, this field is set to the BCD values 20 04 06 00.

### Compatible\_Brands[ ]

A series of unsigned 32-bit integers listing compatible file formats. The major brand must appear in the list of compatible brands. One or more “placeholder” entries with value zero are permitted; such entries should be ignored.

If none of the `Compatible_Brands` fields is set to `'qt'`, then the file is not a QuickTime movie file and is not compatible with this specification. Applications should return an error and close the file, or else invoke a file importer appropriate to one of the specified brands, preferably the major brand. QuickTime currently returns an error when attempting to open a file whose file type, file extension, or MIME type identifies it as a QuickTime movie, but whose file type atom does not include the `'qt'` brand.

**Note:** A common source of this error is an MPEG-4 file incorrectly named with the `.mov` file extension or with the MIME type incorrectly set to “video/quicktime”. MPEG-4 files are automatically imported by QuickTime only when they are correctly identified as MPEG-4 files using the Mac OS file type, file extension, or MIME type.

If you are creating a file type that is fully compatible with the QuickTime file format, one of the `Compatible_Brand` fields must be set to `'qt'`; otherwise QuickTime will not recognize the file as a QuickTime movie.



**Warning:** Use of the QuickTime file format in this manner is subject to license from Apple, Inc.

## Free Space Atoms

---

Both `free` and `skip` atoms designate unused space in the movie data file. These atoms consist of only an atom header (size and type fields), followed by the appropriate number of bytes of free space. When reading a QuickTime movie, your application may safely skip these atoms. When writing or updating a movie, you may reuse the space associated with these atom types.

A `wide` atom typically precedes a movie data atom. The `wide` atom consists only of a type and size field. This occupies 8 bytes—enough space to add an extended size field to the header of the atom that follows, without displacing the contents of that atom. If an atom grows to exceed  $2^{32}$  bytes in size, and it is preceded by a `wide` atom, you may create a new atom header containing an extended size field by overwriting the existing atom header and the preceding `wide` atom.

## Movie Data Atoms

---

As with the `free` and `skip` atoms, the movie data atom is structured quite simply. It consists of an atom header (atom size and type fields), followed by the movie’s media data. Your application can understand the data in this atom only by using the metadata stored in the movie atom. This atom can be quite large, and may exceed  $2^{32}$  bytes, in which case the size field will be set to 1, and the header will contain a 64-bit extended size field.

## Preview Atoms

---

The preview atom contains information that allows you to find the preview image associated with a QuickTime movie. The preview image, or poster, is a representative image suitable for display to the user in, for example, Open dialog boxes. [Figure 1-7](#) (page 32) depicts the layout of the preview atom.

**Figure 1-7** The layout of a preview atom

	Bytes
Preview atom	
Atom size	4
Type = 'pnot'	4
Modification date	4
Version number	2
Atom type	4
Atom index	2

The preview atom has an atom type value of 'pnot' and, following its atom header, contains the following fields:

### Size

A 32-bit integer that specifies the number of bytes in this preview atom.

### Type

A 32-bit integer that identifies the atom type; this field must be set to 'pnot'.

### Modification date

A 32-bit unsigned integer containing a date that indicates when the preview was last updated. The data is in standard Macintosh format.

### Version number

A 16-bit integer that must be set to 0.

### Atom type

A 32-bit integer that indicates the type of atom that contains the preview data. Typically, this is set to 'PICT' to indicate a QuickDraw picture.

### Atom index

A 16-bit integer that identifies which atom of the specified type is to be used as the preview. Typically, this field is set to 1 to indicate that you should use the first atom of the type specified in the atom type field.

**Note:** This specification defines the preview atom primarily for backward compatibility. Current practice is normally to define movie previews by placing information in the movie header atom. See [“Movie Header Atoms”](#) (page 38).



# Movie Atoms

---

This chapter provides a general introduction to QuickTime movie atoms, as well as specific details on the layout and usage of these atoms. Each atom type discussed in this chapter is shown with an accompanying illustration that contains offset information, followed by field descriptions.

This chapter is divided into the following major sections:

- [“Overview of Movie Atoms”](#) (page 34) discusses QuickTime movie atoms, which act as containers for information that describes a movie’s data. A conceptual illustration is provided that shows the organization of a simple, one-track QuickTime movie. Profile atoms, color table atoms, and user data atoms are also discussed.
- [“Track Atoms”](#) (page 46) describes track atoms, which define a single track of a movie. Track profile atoms, track user data atoms, and hint tracks are also discussed.
- [“Media Atoms”](#) (page 62) discusses media atoms, which define a track’s movie data, such as the media type and media time scale.
- [“Sample Atoms”](#) (page 75) discusses sample table atoms, which specify where media samples are located, their duration, and so on. The section also includes examples of how you use these atoms.

**Note:** Media atoms and sample atoms do *not* contain actual sample data, such as video frames or audio samples. They contain metadata used to locate and interpret such samples.

- [“Compressed Movie Resources”](#) (page 88) discusses compressed movie resources, in which a lossless compression algorithm is used to compress the contents of the movie atom, including any track, media, or sample atoms. The contents must be decompressed before the movie atom can be parsed.
- [“Reference Movies”](#) (page 89) discusses movies that contain a reference movie atom (a list of references to alternate movies, as well as the criteria for selecting the correct movie from a list of alternates). Movie atoms that contain a reference movie atom do not necessarily contain track, media, or sample atoms.

## Overview of Movie Atoms

---

QuickTime movie atoms have an atom type of 'moov'. These atoms act as a container for the information that describes a movie's data. This information, or metadata, is stored in a number of different types of atoms. Generally speaking, only metadata is stored in a movie atom. Sample data for the movie, such as audio or video samples, are referenced in the movie atom, but are not contained in it.

The movie atom is essentially a container of other atoms. These atoms, taken together, describe the contents of a movie. At the highest level, movie atoms typically contain track atoms, which in turn contain media atoms. At the lowest level you find the leaf atoms, which contain non-atom data, usually in the form of a table or a set of data elements. For example, a track atom contains an edit atom, which in turn contains an *edit list atom*, a leaf atom which contains data in the form of an edit list table. All of these atoms are discussed later in this document.

[Figure 2-1](#) (page 35) provides a conceptual view of the organization of a simple, one-track QuickTime movie. Each nested box in the illustration represents an atom that belongs to its parent atom. The figure does not show the data regions of any of the atoms. These areas are described in the sections that follow.

Note that this figure shows the organization of a standard movie atom. It is possible to compress the movie metadata using a lossless compression algorithm. In such cases, the movie atom contains only a single child atom—the compressed movie atom ('cmov'). When this child atom is uncompressed, its contents conform to the structure shown in the following illustration. For details, see [“Compressed Movie Resources”](#) (page 88)

It is also possible to create a reference movie, a movie that refers to other movies; in this case the movie atom may contain only a reference movie atom ('rma'). For details, see [“Reference Movies”](#). Ultimately, the chain must end in either a standard movie atom, such as the one in the following illustration, or a compressed movie atom, which can be uncompressed to obtain the same structure.

Figure 2-1 Sample organization of a one-track video movie

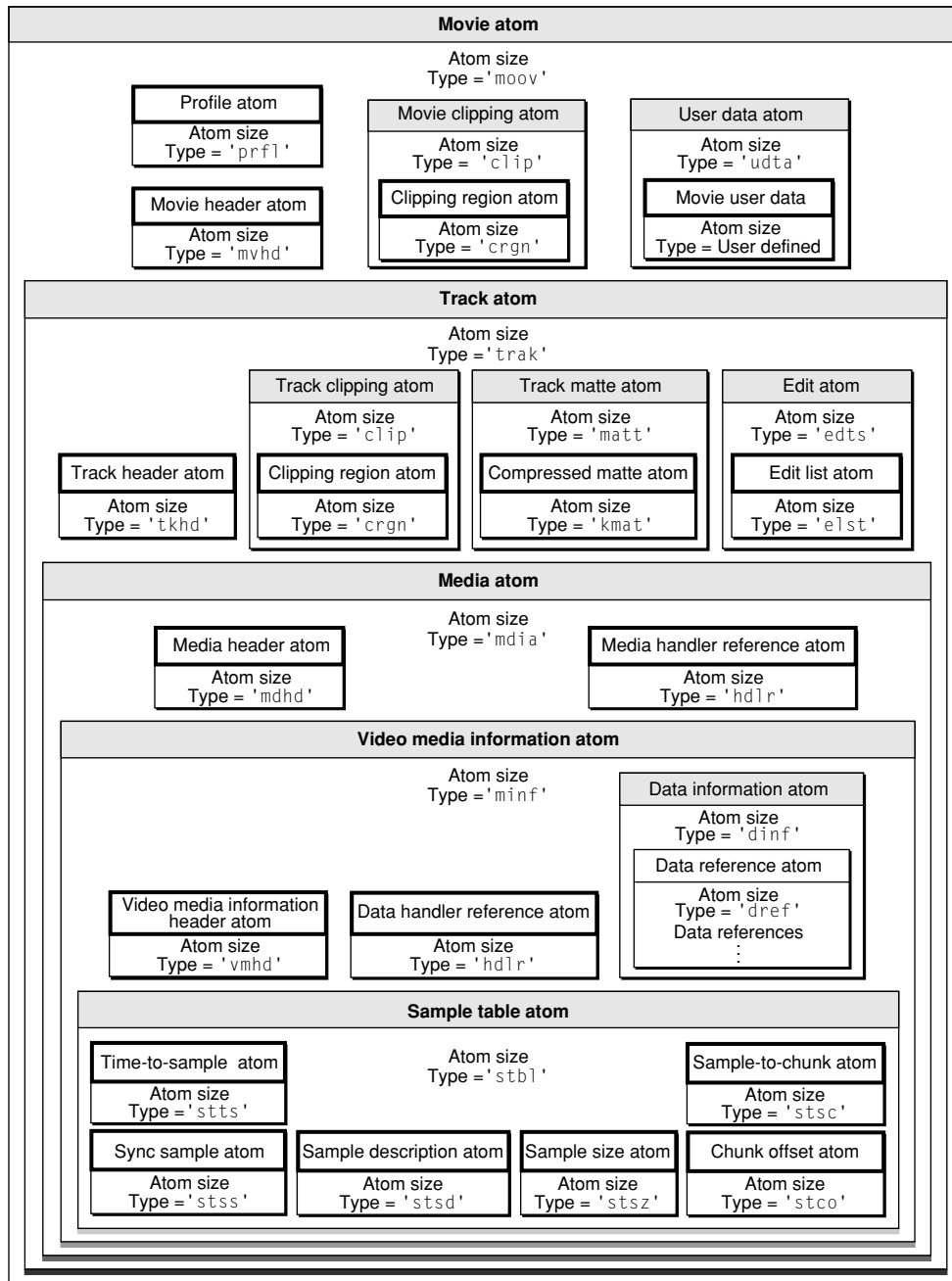

## The Movie Atom

You use movie atoms to specify the information that defines a movie—that is, the information that allows your application to interpret the sample data that is stored elsewhere. The movie atom may contain a movie profile atom, which summarizes the main features of the movie, such as the necessary codecs and maximum bitrate, and it usually contains a movie header atom, which defines the time scale and duration information for the entire movie, as well as its display characteristics. In addition, the movie atom contains a track atom for each track in the movie.

Movie Atoms

The movie atom has an atom type of 'moov'. It contains other types of atoms, including at least one of three possible atoms—the movie header atom ('mvhd'), the compressed movie atom ('cmov'), or a reference movie atom ('rmra'). An uncompressed movie atom can contain both a movie header atom and a reference movie atom, but it must contain at least one of the two. It can also contain several other atoms, such as a profile atom ('prfl'), clipping atom ('clip'), one or more track atoms ('trak'), a color table atom ('ctab'), and a user data atom ('udta').

Compressed movie atoms and reference movie atoms are discussed separately. This section describes normal uncompressed movie atoms.

**Note:** The movie profile atom is introduced in the *QuickTime File Format Specification* for 2004.

Figure 2-2 (page 36) shows the layout of a typical movie atom.

**Note:** As previously mentioned, leaf atoms are shown as white boxes, while container atoms are shown as gray boxes.

**Figure 2-2** The layout of a movie atom

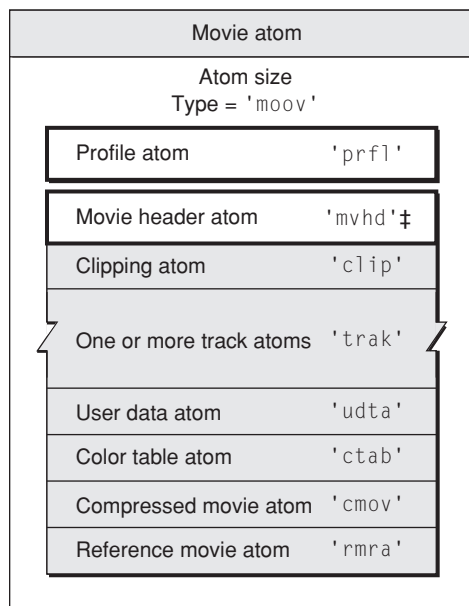

‡ Required atom

A movie atom may contain the following fields:

Size

The number of bytes in this movie atom.

Type

The type of this movie atom; this field must be set to 'moov'.

Profile atom

See [“The Movie Profile Atom”](#) (page 37) for more information.

## Movie Atoms

## Movie header atom

See “[Movie Header Atoms](#)” (page 38) for more information.

## Movie clipping atom

See “[Clipping Atoms](#)” (page 51) for more information.

## Track atoms

See “[Track Atoms](#)” (page 46) for details on track atoms and their associated atoms.

## User data atom

See “[User Data Atoms](#)” (page 42) for more information about user data atoms.

## Color table atom

See “[Color Table Atoms](#)” (page 41) for a discussion of the color table atom.

## Compressed movie atom

See “[Compressed Movie Resources](#)” (page 88) for a discussion of compressed movie atoms.

## Reference movie atom

See “[Reference Movies](#)” (page 89) for a discussion of reference movie atoms.

## The Movie Profile Atom

---

The movie profile atom summarizes the features and complexity of a movie, such as the required codecs and maximum bitrate, in order to help player applications or devices quickly determine whether they have the necessary resources to play the movie.

Features for a movie typically include the movie’s maximum video and audio bitrate, a list of audio and video codec types, the movie’s video dimensions, and any applicable MPEG-4 profiles and levels. This is all information that can also be obtained by examining the contents of the movie file in more detail. This summary is intended to allow applications or devices to quickly determine whether they can play the movie. It is not intended as a container for information that is not found elsewhere in the movie, and should not be used as one.

**Note:** The fact that a feature does not appear in the profile atom does not mean it is not present in the movie. The profile atom itself may not be present, or may list only a subset of movie features. The features listed in the profile atom are all present, but the list is not necessarily complete.

When creating a profile atom, it is permissible to omit some features that are present in the movie, but it is required to fully specify any features that are included in the profile. For example, a movie containing video may or may not have a video codec type feature in the profile atom, but if any video codec type feature is included in the profile atom, every required video codec must be listed in the profile atom.

The movie profile atom is a profile atom ('prfl') whose parent is a movie atom. This is distinct from the track profile atom, whose parent is a track atom. The structure of the profile atom is identical in both cases, but the contents of a movie profile atom describe the movie as a whole, while the contents of a track profile atom are specific to a particular track.

The movie profile atom is a new feature of the *QuickTime File Format Specification* for 2004.

The profile atom contains a list of features. In a movie profile atom, these features summarize the movie as a whole. In a track profile atom, these features describe a particular track.

Each entry in the feature list consists of four 32-bit fields:

- The first field is reserved and must be set to zero.
- The second field is the part-ID, which defines the feature as being either brand-specific or universal. Brand-specific features are particular to a specific brand. Universal features are can be found in any file type that uses the profile atom. Universal features have a part-ID of four ASCII spaces (0x20202020). Brand-specific features have a part-ID that is one of the Compatible\_Brand codes for that file type, as specified in the file type atom ('ftyp'). For example, the part-ID for QuickTime-specific features is 'qt '. All features described in this document, however, are universal.
- The third field is the feature code, or name, a 32-bit unsigned integer that is usually best interpreted as four ASCII characters. Example: the maximum video bitrate feature has a feature code or name of 'mvbr'. It is permissible to use a feature code value of zero (0x00000000, *not* four ASCII zero characters) as a placeholder in one or more name-value pairs. The reader should ignore feature codes of value zero.
- The fourth field is the value, which is also a 32-bit field. The value may be a signed or unsigned integer, or a fixed-point value, or contain sub-fields, or consist of a packed array; it can be interpreted only in relation to the specific feature.

For details on the structure and contents of profile atoms, see [“Profile Atom Guidelines”](#) (page 281).

## Movie Header Atoms

---

You use the movie header atom to specify the characteristics of an entire QuickTime movie. The data contained in this atom defines characteristics of the entire QuickTime movie, such as time scale and duration. It has an atom type value of 'mvhd'.

[Figure 2-3](#) (page 39) shows the layout of the movie header atom. The movie header atom is a leaf atom.

**Figure 2-3** The layout of a movie header atom

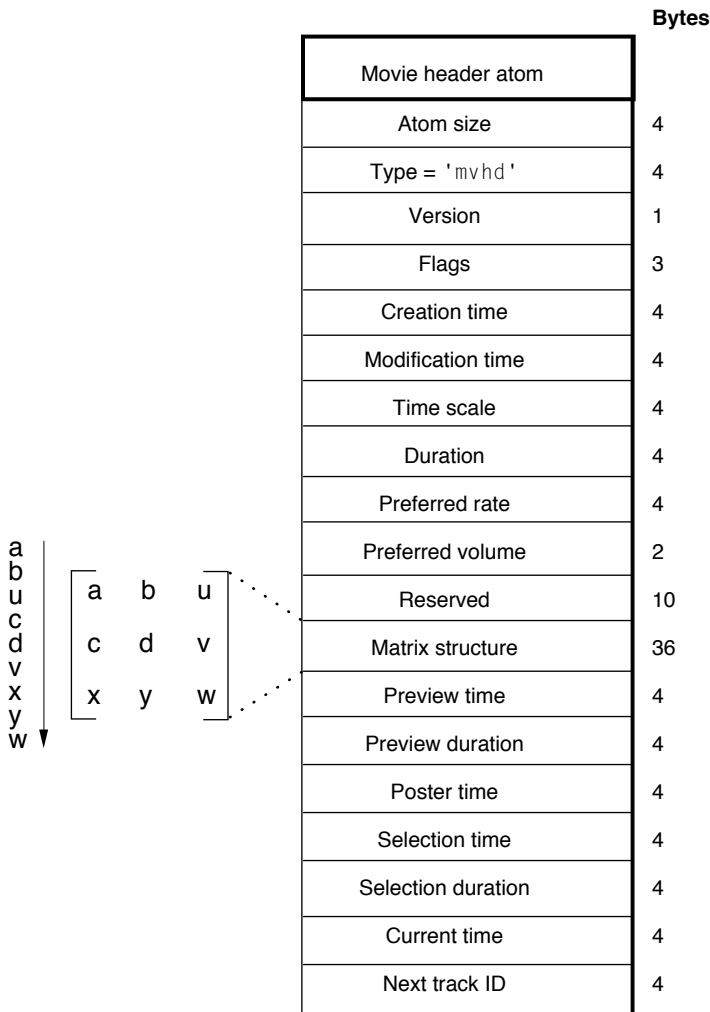

You define a movie header atom by specifying the following data elements.

**Size**

A 32-bit integer that specifies the number of bytes in this movie header atom.

**Type**

A 32-bit integer that identifies the atom type; must be set to 'mvhd'.

**Version**

A 1-byte specification of the version of this movie header atom.

**Flags**

Three bytes of space for future movie header flags.

**Creation time**

A 32-bit integer that specifies the calendar date and time (in seconds since midnight, January 1, 1904) when the movie atom was created. It is strongly recommended that this value should be specified using coordinated universal time (UTC).

## Movie Atoms

## Modification time

A 32-bit integer that specifies the calendar date and time (in seconds since midnight, January 1, 1904) when the movie atom was changed. BooleanIt is strongly recommended that this value should be specified using coordinated universal time (UTC).

## Time scale

A time value that indicates the time scale for this movie—that is, the number of time units that pass per second in its time coordinate system. A time coordinate system that measures time in sixtieths of a second, for example, has a time scale of 60.

## Duration

A time value that indicates the duration of the movie in time scale units. Note that this property is derived from the movie's tracks. The value of this field corresponds to the duration of the longest track in the movie.

## Preferred rate

A 32-bit fixed-point number that specifies the rate at which to play this movie. A value of 1.0 indicates normal rate.

## Preferred volume

A 16-bit fixed-point number that specifies how loud to play this movie's sound. A value of 1.0 indicates full volume.

## Reserved

Ten bytes reserved for use by Apple. Set to 0.

## Matrix structure

The matrix structure associated with this movie. A matrix shows how to map points from one coordinate space into another. See "[Matrices](#)" (page 222) for a discussion of how display matrices are used in QuickTime.

## Preview time

The time value in the movie at which the preview begins.

## Preview duration

The duration of the movie preview in movie time scale units.

## Poster time

The time value of the time of the movie poster.

## Selection time

The time value for the start time of the current selection.

## Selection duration

The duration of the current selection in movie time scale units.

## Current time

The time value for current time position within the movie.

## Next track ID

A 32-bit integer that indicates a value to use for the track ID number of the next track added to this movie. Note that 0 is not a valid track ID value.



**Note:** The creation and modification date should be set using coordinated universal time (UTC). In prior versions of the QuickTime file format, this was not specified, and these fields were commonly set to local time for the time zone where the movie was created.

## Color Table Atoms

Color table atoms define a list of preferred colors for displaying the movie on devices that support only 256 colors. The list may contain up to 256 colors. These optional atoms have a type value of 'ctab'. The color table atom contains a Macintosh color table data structure.

Figure 2-4 (page 41) shows the layout of the color table atom.

**Figure 2-4** The layout of a color table atom

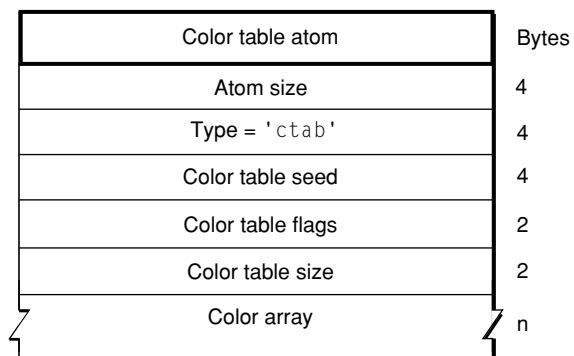

The color table atom contains the following data elements.

### Size

A 32-bit integer that specifies the number of bytes in this color table atom.

### Type

A 32-bit integer that identifies the atom type; this field must be set to 'ctab'.

### Color table seed

A 32-bit integer that must be set to 0.

### Color table flags

A 16-bit integer that must be set to 0x8000.

### Color table size

A 16-bit integer that indicates the number of colors in the following color array. This is a zero-relative value; setting this field to 0 means that there is one color in the array.

### Color array

An array of colors. Each color is made of four unsigned 16-bit integers. The first integer must be set to 0, the second is the red value, the third is the green value, and the fourth is the blue value.

## User Data Atoms

User data atoms allow you to define and store data associated with a QuickTime object, such as a movie, track, or media. This includes both information that QuickTime looks for, such as copyright information or whether a movie should loop, and arbitrary information—provided by and for your application—that QuickTime simply ignores.

A user data atom whose immediate parent is a movie atom contains data relevant to the movie as a whole. A user data atom whose parent is a track atom contains information relevant to that specific track. A QuickTime movie file may contain many user data atoms, but only one user data atom is allowed as the immediate child of any given movie atom or track atom.

The user data atom has an atom type of 'udta'. Inside the user data atom is a list of atoms describing each piece of user data. User data provides a simple way to extend the information stored in a QuickTime movie. For example, user data atoms can store a movie's window position, playback characteristics, or creation information.

This section describes the data atoms that QuickTime recognizes. You may create new data atom types that your own application recognizes. Applications should ignore any data atom types they do not recognize.

Figure 2-5 (page 42) shows the layout of a user data atom.

**Figure 2-5** The layout of a user data atom

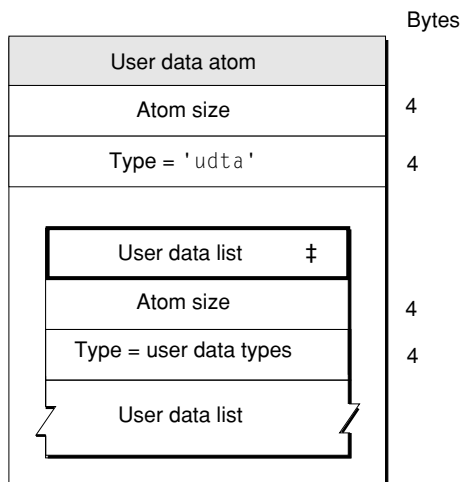

‡ Required atom

The user data atom contains the following data elements.

### Size

A 32-bit integer that specifies the number of bytes in this user data atom.

### Type

A 32-bit integer that identifies the atom type; this field must be set to 'udta'.

## User data list

A user data list that is formatted as a series of atoms. Each data element in the user data list contains size and type information along with its data. For historical reasons, the data list is optionally terminated by a 32-bit integer set to 0. If you are writing a program to read user data atoms, you should allow for the terminating 0. However, if you are writing a program to create user data atoms, you can safely leave out the trailing 0.

[Table 2-1](#) (page 43) lists the currently defined list entry types.

**Table 2-1** User data list entry types

List entry type	Description	For Sorting
'@arg'	Name of arranger	
'@ark'	Keyword(s) for arranger	X
'@cok'	Keyword(s) for composer	X
'@com'	Name of composer	
'@cpy'	Copyright statement	
'@day'	Date the movie content was created	
'@dir'	Name of movie's director	
'@ed1' to '@ed9'	Edit dates and descriptions	
'@fmt'	Indication of movie format (computer-generated, digitized, and so on)	
'@inf'	Information about the movie	
'@isr'	ISRC code	
'@lab'	Name of record label	
'@lal'	URL of record label	
'@mak'	Name of file creator or maker	
'@mal'	URL of file creator or maker	
'@nak'	Title keyword(s) of the content	X
'@nam'	Title of the content	
'@pdk'	Keyword(s) for producer	X
'@phg'	Recording copyright statement, normally preceded by the symbol ©	
'@prd'	Name of producer	
'@prf'	Names of performers	

List entry type	Description	For Sorting
'@prk'	Keyword(s) of main artist and performer	X
'@prl'	URL of main artist and performer	
'@req'	Special hardware and software requirements	
'@snk'	Sub-title keyword(s) of the content	X
'@snm'	Sub-title of content	
'@src'	Credits for those who provided movie source content	
'@swf'	Name of songwriter	
'@swk'	Keyword(s) for songwriter	X
'@swr'	Name and version number of the software (or hardware) that generated this movie	
'@wrt'	Name of movie's writer	
'AllF'	Play all frames—byte indicating that all frames of video should be played, regardless of timing	
'hint'	Hint track information—statistical data for real-time streaming of a particular track. For more information, see <a href="#">“Hint Track User Data Atom”</a> (page 168).	
'hnti'	Hint info atom—data used for real-time streaming of a movie or a track. For more information, see <a href="#">“Movie Hint Info Atom”</a> (page 168) and <a href="#">“Hint Track User Data Atom”</a> (page 168).	
'name'	Name of object	
'LOOP'	Long integer indicating looping style. This atom is not present unless the movie is set to loop. Values are 0 for normal looping, 1 for palindromic looping.	
'ptv'	Print to video—display movie in full screen mode. This atom contains a 16-byte structure, described in <a href="#">“Print to Video (Full Screen Mode)”</a> (page 45).	
'Se10'	Play selection only—byte indicating that only the selected area of the movie should be played	
'WLOC'	Default window location for movie—two 16-bit values, {x,y}	

The user-data items labelled “keywords” and marked as “For Sorting” are for use when the display text does not have a pre-determined sorting order (for example, in oriental languages when the sorting depends on the contextual meaning). These keywords can be sorted algorithmically to place the corresponding items in correct order.

The window location, looping, play selection only, play all frames, and print to video atoms control the way QuickTime displays a movie. These atoms are interpreted *only* if the user data atom's immediate parent is a movie atom ('moov'). If they are included as part of a track atom's user data, they are ignored.

## User Data Text Strings and Language Codes

---

All user data list entries whose type begins with the © character (ASCII 169) are defined to be international text. These list entries must contain a list of text strings with associated language codes. By storing multiple versions of the same text, a single user data text item can contain translations for different languages.

The list of text strings uses a small integer atom format, which is identical to the QuickTime atom format except that it uses 16-bit values for size and type instead of 32-bit values. The first value is the size of the string, including the size and type, and the second value is the language code for the string.

User data text strings may use either Macintosh text encoding or Unicode text encoding. The format of the language code determines the text encoding format. Macintosh language codes are followed by Macintosh-encoded text. If the language code is specified using the ISO language codes listed in specification ISO 639-2/T, the text uses Unicode text encoding. Multiple versions of the same text may use different encoding schemes. When Unicode is used, the text is in UTF-8 unless it starts with a byte-order-mark (BOM, 0xFEFF. ), whereupon the text is in UTF-16. Both the BOM and the UTF-16 text should be big-endian.

**Important:** Language code values less than 0x800 are Macintosh language codes; larger values are ISO language codes.

ISO language codes are three-character codes. In order to fit inside a 16-bit field, the characters must be packed into three 5-bit sub-fields. This packing is described in [ISO Language Codes](#) (page 222).

## Print to Video (Full Screen Mode)

---

A movie atom's user data atom may contain a print to video atom ('ptv'). If a print to video atom is present, QuickTime plays the movie in full-screen mode, with no window and no visible controller. Any portion of the screen not occupied by the movie is cleared to black. The user must press the `esc` key to exit full-screen mode.

This atom is often added and removed transiently to control the display mode of a movie for a single presentation, but it can also be stored as part of the permanent movie file.

The print to video atom consists of the following data.

### Size

A 32-bit integer that specifies the number of bytes in this user data item.

### Type

A 32-bit integer that identifies the item type; this field must be set to 'ptv'. Note that the fourth character is an ASCII blank (0x20).

### Display size

A 16-bit *little-endian* integer indicating the display size for the movie: 0 indicates that the movie should be played at its normal size; 1 indicates that the movie should be played at double size;

2 indicates that the movie should be played at half size; 3 indicates that the movie should be scaled to fill the screen; 4 indicates that the movie should be played at its current size (this last value is normally used when the print to video atom is inserted transiently and the movie has been temporarily resized).

#### Reserved1

A 16-bit integer whose value should be 0.

#### Reserved2

A 16-bit integer whose value should be 0.

#### Slide show

An 8-bit Boolean whose value is 1 for a slide show. In slide show mode, the movie advances one frame each time the right-arrow key is pressed. Audio is muted.

#### Play on open

An 8-bit Boolean whose value is normally 1, indicating that the movie should play when opened. Since there is no visible controller in full-screen mode, applications should always set this field to 1 to prevent user confusion.

## Track Atoms

---

Track atoms define a single track of a movie. A movie may consist of one or more tracks. Each track is independent of the other tracks in the movie and carries its own temporal and spatial information. Each track atom contains its associated media atom.

Tracks are used specifically for the following purposes:

- To contain media data references and descriptions (media tracks).
- To contain modifier tracks (tweens, and so forth).
- To contain packetization information for streaming protocols (hint tracks). Hint tracks may contain references to media sample data or copies of media sample data. For more information about hint tracks, refer to [“Hint Media”](#) (page 166).

Note that a QuickTime movie cannot consist solely of hint tracks or modifier tracks; there must be at least one media track. Furthermore, media tracks cannot be deleted from a hinted movie, even if the hint tracks contain copies of the media sample data—in addition to the hint tracks, the entire unhinted movie must remain.

[Figure 2-6](#) (page 47) shows the layout of a track atom. Track atoms have an atom type value of 'trak'. The track atom requires a track header atom ('tkhd') and a media atom ('mdia'). Other child atoms are optional, and may include a track profile atom ('prfl'), a track clipping atom ('clip'), a track matte atom ('matt'), an edit atom ('edts'), a track reference atom ('tref'), a track load settings atom ('load'), a track input map atom ('imap'), and a user data atom ('udta').

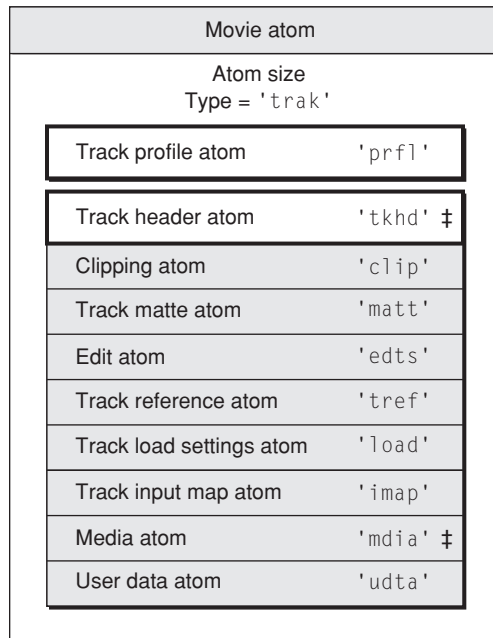
**Figure 2-6** The layout of a track atom

‡ Required atom

Track atoms contain the following data elements.

#### Size

A 32-bit integer that specifies the number of bytes in this track atom.

#### Type

A 32-bit integer that identifies the atom type; this field must be set to 'trak'.

#### Track profile atom

See [“Track Profile Atom”](#) (page 48) for details.

#### Track header atom

See [“Track Header Atoms”](#) (page 48) for details.

#### Clipping atom

See [“Clipping Atoms”](#) (page 51) for more information.

#### Track matte atom

See [“Track Matte Atoms”](#) (page 52) for more information.

#### Edit atom

See [“Edit Atoms”](#) (page 54) for details.

#### Track reference atom

See [“Track Reference Atoms”](#) (page 57) for details.

#### Track load settings atom

See [“Track Load Settings Atoms”](#) (page 56) for details.

#### Track input map atom

See [“Track Input Map Atoms”](#) (page 59) for details.

Media atom

See [“Media Atoms”](#) (page 62) for details.

User-defined data atom

See [“User Data Atoms”](#) (page 42) for more information.

## Track Profile Atom

---

Profile atoms can be children of movie atoms or track atoms. For details on profile atoms, see [“The Movie Profile Atom”](#) (page 37).

## Track Header Atoms

---

The track header atom specifies the characteristics of a single track within a movie. A track header atom contains a size field that specifies the number of bytes and a type field that indicates the format of the data (defined by the atom type 'tkhd').

[Figure 2-7](#) (page 49) shows the structure of the track header atom.



**Figure 2-7** The layout of a track header atom

Track header atom		Bytes
Atom size	4	4
Type = 'tkhd'	4	4
Version	1	1
Flags	3	3
Creation time	4	4
Modification time	4	4
Track ID	4	4
Reserved	4	4
Duration	4	4
Reserved	8	8
Layer	2	2
Alternate group	2	2
Volume	2	2
Reserved	2	2
Matrix structure	36	36
Track width	4	4
Track height	4	4

The track header atom contains the track characteristics for the track, including temporal, spatial, and volume information.

Track header atoms contain the following data elements.

**Size**

A 32-bit integer that specifies the number of bytes in this track header atom.

**Type**

A 32-bit integer that identifies the atom type; this field must be set to 'tkhd'.

**Version**

A 1-byte specification of the version of this track header.

## Flags

Three bytes that are reserved for the track header flags. These flags indicate how the track is used in the movie. The following flags are valid (all flags are enabled when set to 1).

## Track enabled

Indicates that the track is enabled. Flag value is 0x0001.

## Track in movie

Indicates that the track is used in the movie. Flag value is 0x0002.

## Track in preview

Indicates that the track is used in the movie's preview. Flag value is 0x0004.

## Track in poster

Indicates that the track is used in the movie's poster. Flag value is 0x0008.

## Creation time

A 32-bit integer that indicates the calendar date and time (expressed in seconds since midnight, January 1, 1904) when the track header was created. It is strongly recommended that this value should be specified using coordinated universal time (UTC).

## Modification time

A 32-bit integer that indicates the calendar date and time (expressed in seconds since midnight, January 1, 1904) when the track header was changed. It is strongly recommended that this value should be specified using coordinated universal time (UTC).

## Track ID

A 32-bit integer that uniquely identifies the track. The value 0 cannot be used.

## Reserved

A 32-bit integer that is reserved for use by Apple. Set this field to 0.

## Duration

A time value that indicates the duration of this track (in the movie's time coordinate system). Note that this property is derived from the track's edits. The value of this field is equal to the sum of the durations of all of the track's edits. If there is no edit list, then the duration is the sum of the sample durations, converted into the movie timescale.

## Reserved

An 8-byte value that is reserved for use by Apple. Set this field to 0.

## Layer

A 16-bit integer that indicates this track's spatial priority in its movie. The QuickTime Movie Toolbox uses this value to determine how tracks overlay one another. Tracks with lower layer values are displayed in front of tracks with higher layer values.

## Alternate group

A 16-bit integer that specifies a collection of movie tracks that contain alternate data for one another. QuickTime chooses one track from the group to be used when the movie is played. The choice may be based on such considerations as playback quality, language, or the capabilities of the computer.

Volume

A 16-bit fixed-point value that indicates how loudly this track’s sound is to be played. A value of 1.0 indicates normal volume.

Reserved

A 16-bit integer that is reserved for use by Apple. Set this field to 0.

Matrix structure

The matrix structure associated with this track. See [Figure 2-8](#) (page 51) for an illustration of a matrix structure.

Track width

A 32-bit fixed-point number that specifies the width of this track in pixels.

Track height

A 32-bit fixed-point number that indicates the height of this track in pixels.

## Clipping Atoms

Clipping atoms specify the clipping regions for movies and for tracks. The clipping atom has an atom type value of 'clip'.

[Figure 2-8](#) (page 51) shows the layout of a clipping atom.

**Figure 2-8** The layout of a clipping atom

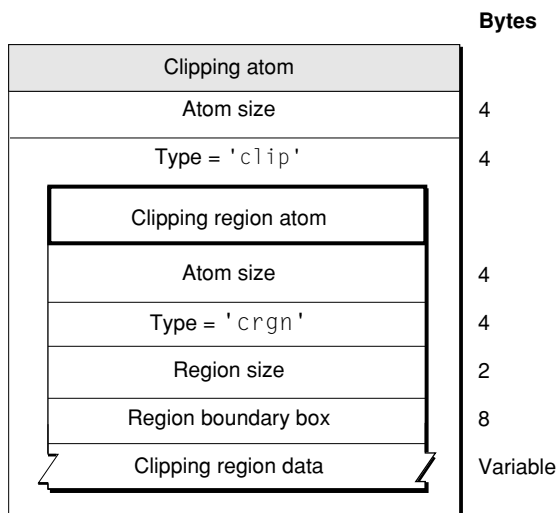

Clipping atoms contain the following data elements.

Size

A 32-bit integer that specifies the number of bytes in this clipping atom.

Type

A 32-bit integer that identifies the atom type; this field must be set to 'clip'.

Clipping region atom

See “[Clipping Region Atoms](#)” (page 52).

## Clipping Region Atoms

---

The clipping region atom contains the data that specifies the clipping region, including its size, bounding box, and region. Clipping region atoms have an atom type value of 'crgn'.

The layout of the clipping region atom is shown in [Figure 2-8](#) (page 51).

Clipping region atoms contain the following data elements.

Size

A 32-bit integer that specifies the number of bytes in this clipping region atom.

Type

A 32-bit integer that identifies the atom type; this field must be set to 'crgn'.

Region size

The region size, region boundary box, and clipping region data fields constitute a QuickDraw region.

Region boundary box

The region size, region boundary box, and clipping region data fields constitute a QuickDraw region.

Clipping region data

The region size, region boundary box, and clipping region data fields constitute a QuickDraw region.

## Track Matte Atoms

---

Track matte atoms are used to visually blend the track's image when it is displayed.

Track matte atoms have an atom type value of 'matt'.

[Figure 2-9](#) (page 53) shows the layout of track matte atoms.

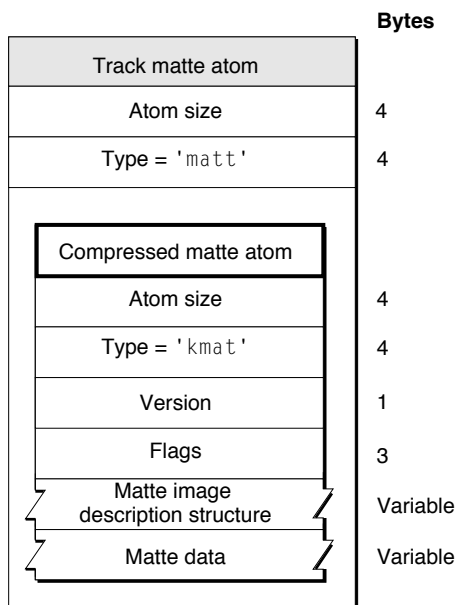
**Figure 2-9** The layout of a track matte atom

Track matte atoms contain the following data elements.

**Size**

A 32-bit integer that specifies the number of bytes in this track matte atom.

**Type**

A 32-bit integer that identifies the atom type; this field must be set to 'matt'.

**Compressed matte atom**

The actual matte data.

See [“Compressed Matte Atoms”](#) (page 53) for details.

## Compressed Matte Atoms

---

The compressed matte atom specifies the image description structure and the matte data associated with a particular matte atom. Compressed matte atoms have an atom type value of 'kmat'.

The layout of the compressed matte atom is shown in [Figure 2-9](#) (page 53).

Compressed matte atoms contain the following data elements.

**Size**

A 32-bit integer that specifies the number of bytes in this compressed matte atom.

**Type**

A 32-bit integer that identifies the atom type; this field must be set to 'kmat'.

**Version**

A 1-byte specification of the version of this compressed matte atom.

Flags

Three bytes of space for flags. Set this field to 0.

Matte image description structure

An image description structure associated with this matte data. The image description contains detailed information that governs how the matte data is used. See [“Video Sample Description”](#) (page 100) for more information about image descriptions.

Matte data

The compressed matte data, which is of variable length.

## Edit Atoms

---

You use edit atoms to define the portions of the media that are to be used to build up a track for a movie. The edits themselves are contained in an edit list table, which consists of time offset and duration values for each segment. Edit atoms have an atom type value of 'edts'.

[Figure 2-10](#) (page 54) shows the layout of an edit atom.

In the absence of an edit list, the presentation of a track starts immediately. An empty edit is used to offset the start time of a track.

**Note:** If the edit atom or the edit list atom is missing, you can assume that the entire media is used by the track.

**Figure 2-10** The layout of an edit atom

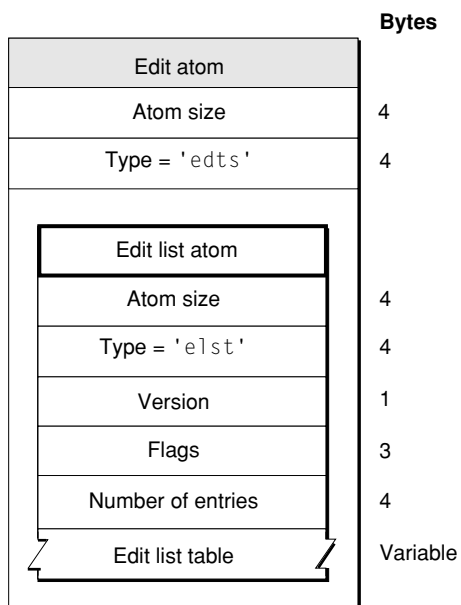

Edit atoms contain the following data elements.

Size

A 32-bit integer that specifies the number of bytes in this edit atom.

**Type**

A 32-bit integer that identifies the atom type; this field must be set to 'edts'.

**Edit list atom**

See “[Edit List Atoms](#)” (page 55).

## Edit List Atoms

---

You use the edit list atom, also shown in [Figure 2-10](#) (page 54), to map from a time in a movie to a time in a media, and ultimately to media data. This information is in the form of entries in an edit list table, shown in [Figure 2-11](#) (page 55). Edit list atoms have an atom type value of 'elst'.

Edit list atoms contain the following data elements.

**Size**

A 32-bit integer that specifies the number of bytes in this edit list atom.

**Type**

A 32-bit integer that identifies the atom type; this field must be set to 'elst'.

**Version**

A 1-byte specification of the version of this edit list atom.

**Flags**

Three bytes of space for flags. Set this field to 0.

**Number of entries**

A 32-bit integer that specifies the number of entries in the edit list atom that follows.

**Edit list table**

An array of 32-bit values, grouped into entries containing 3 values each. [Figure 2-11](#) (page 55) shows the layout of the entries in this table.

**Figure 2-11** The layout of an edit list table entry

Track duration	Media time	Media rate	Field
4	4	4	Bytes

An edit list table entry contains the following elements.

**Track duration**

A 32-bit integer that specifies the duration of this edit segment in units of the movie’s time scale.

**Media time**

A 32-bit integer containing the starting time within the media of this edit segment (in media timescale units). If this field is set to –1, it is an empty edit. The last edit in a track should never be an empty edit. Any difference between the movie’s duration and the track’s duration is expressed as an implicit empty edit.

**Media rate**

A 32-bit fixed-point number that specifies the relative rate at which to play the media corresponding to this edit segment. This rate value cannot be 0 or negative.

## Track Load Settings Atoms

---

Track load settings atoms contain information that indicates how the track is to be used in its movie. Applications that read QuickTime files can use this information to process the movie data more efficiently. Track load settings atoms have an atom type value of 'load'.

**Figure 2-12** The layout of a track load settings atom

	Bytes
Track load settings atom	
Atom size	4
Type = 'load'	4
Preload start time	4
Preload duration	4
Preload flags	4
Default hints	4

Track load settings atoms contain the following data elements.

**Size**

A 32-bit integer that specifies the number of bytes in this track load settings atom.

**Type**

A 32-bit integer that identifies the atom type; this field must be set to 'load'.

**Preload start time**

A 32-bit integer specifying the starting time, in the movie's time coordinate system, of a segment of the track that is to be preloaded. Used in conjunction with the preload duration.

**Preload duration**

A 32-bit integer specifying the duration, in the movie's time coordinate system, of a segment of the track that is to be preloaded. If the duration is set to -1, it means that the preload segment extends from the preload start time to the end of the track. All media data in the segment of the track defined by the preload start time and preload duration values should be loaded into memory when the movie is to be played.

**Preload flags**

A 32-bit integer containing flags governing the preload operation. Only two flags are defined, and they are mutually exclusive. If preload flags is set to 1, the track is to be preloaded regardless of whether it is enabled. If preload flags is set to 2, the track is to be preloaded only if it is enabled.



### Default hints

A 32-bit integer containing playback hints. More than one flag may be enabled. Flags are enabled by setting them to 1. The following flags are defined.

#### Double buffer

This flag indicates that the track should be played using double-buffered I/O. This flag's value is 0x0020.

#### High quality

This flag indicates that the track should be displayed at highest possible quality, without regard to real-time performance considerations. This flag's value is 0x0100.

## Track Reference Atoms

---

Track reference atoms define relationships between tracks. Track reference atoms allow one track to specify how it is related to other tracks. For example, if a movie has three video tracks and three sound tracks, track references allow you to identify the related sound and video tracks. Track reference atoms have an atom type value of 'tref'.

Track references are unidirectional and point from the recipient track to the source track. For example, a video track may reference a time code track to indicate where its time code is stored, but the time code track would not reference the video track. The time code track is the source of time information for the video track.

A single track may reference multiple tracks. For example, a video track could reference a sound track to indicate that the two are synchronized and a time code track to indicate where its time code is stored.

A single track may also be referenced by multiple tracks. For example, both a sound and video track could reference the same time code track if they share the same timing information.

If this atom is not present, the track is not referencing any other track in any way. Note that the array of track reference type atoms is sized to fill the track reference atom. Track references with a reference index of 0 are permitted. This indicates no reference.

[Figure 2-13](#) (page 58) shows the layout of a track reference atom.

**Figure 2-13** The layout of a track reference atom

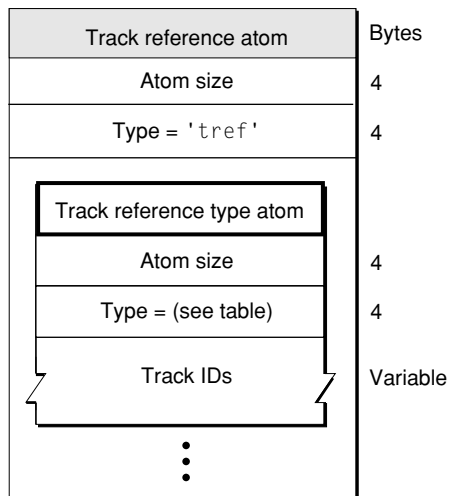

A track reference atom contains the following data elements.

**Size**

A 32-bit integer that specifies the number of bytes in this track reference atom.

**Type**

A 32-bit integer that identifies the atom type; this field must be set to 'tref'.

**Track reference type atoms**

A list of track reference type atoms containing the track reference information. These atoms are described next.

Each track reference atom defines relationships with tracks of a specific type. The reference type implies a track type. [Table 2-2](#) (page 58) shows the track reference types and their descriptions.

**Table 2-2** Track reference types

Reference type	Description
'tmcd'	Time code. Usually references a time code track.
'chap'	Chapter or scene list. Usually references a text track.
'sync'	Synchronization. Usually between a video and sound track. Indicates that the two tracks are synchronized. The reference can be from either track to the other, or there may be two references.
'scpt'	Transcript. Usually references a text track.
'ssrc'	Nonprimary source. Indicates that the referenced track should send its data to this track, rather than presenting it. The referencing track will use the data to modify how it presents its data. See <a href="#">“Track Input Map Atoms”</a> (page 59) for more information.
'hint'	The referenced tracks contain the original media for this hint track.

Each track reference type atom contains the following data elements.

**Size**

A 32-bit integer that specifies the number of bytes in this track reference type atom.

**Type**

A 32-bit integer that identifies the atom type; this field must be set to one of the values shown in [Table 2-2](#) (page 58).

**Track IDs**

A list of track ID values (32-bit integers) specifying the related tracks. Note that this is one case where track ID values can be set to 0. Unused entries in the atom may have a track ID value of 0. Setting the track ID to 0 may be more convenient than deleting the reference.

You can determine the number of track references stored in a track reference type atom by subtracting its header size from its overall size and then dividing by the size, in bytes, of a track ID.

## Track Input Map Atoms

---

Track input map atoms define how data being sent to this track from its nonprimary sources is to be interpreted. Track references of type 'src' define a track's secondary data sources. These sources provide additional data that is to be used when processing the track. Track input map atoms have an atom type value of 'imap'.

[Figure 2-14](#) (page 60) shows the layout of a track input atom. This atom contains one or more track input atoms. Note that the track input map atom is a QT atom structure.

**Figure 2-14** The layout of a track input map atom

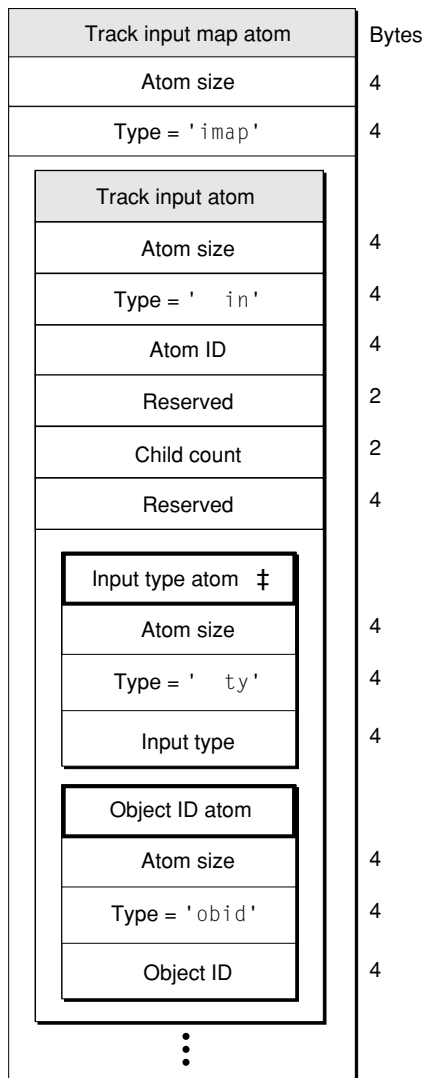

‡ Required atom

Each track input map atom contains the following data elements.

**Size**

A 32-bit integer that specifies the number of bytes in this track input map atom.

**Type**

A 32-bit integer that identifies the atom type; this field must be set to 'imap'.

**Track input atoms**

A list of track input atoms specifying how to use the input data.

The input map defines all of the track's secondary inputs. Each secondary input is defined using a separate track input atom.

Each track input atom contains the following data elements.

## Movie Atoms

## Size

A 32-bit integer that specifies the number of bytes in this track input atom.

## Type

A 32-bit integer that identifies the atom type; this field must be set to 'in' (note that the two leading bytes must be set to 0x00).

## Atom ID

A 32-bit integer relating this track input atom to its secondary input. The value of this field corresponds to the index of the secondary input in the track reference atom. That is, the first secondary input corresponds to the track input atom with an atom ID value of 1; the second to the track input atom with an atom ID of 2, and so on.

## Reserved

A 16-bit integer that must be set to 0.

## Child count

A 16-bit integer specifying the number of child atoms in this atom.

## Reserved

A 32-bit integer that must be set to 0.

The track input atom, in turn, may contain two other types of atoms: input type atoms and object ID atoms. The input type atom is required; it specifies how the data is to be interpreted.

The input type atom contains the following data elements.

## Size

A 32-bit integer that specifies the number of bytes in this input type atom.

## Type

A 32-bit integer that identifies the atom type; this field must be set to 'ty' (note that the two leading bytes must be set to 0x00).

## Input type

A 32-bit integer that specifies the type of data that is to be received from the secondary data source. [Table 2-3](#) (page 61) lists valid values for this field.

**Table 2-3** Input types

Input identifier	Value	Description
kTrackModifierTypeMatrix	1	A 3 x 3 transformation matrix to transform the track's location, scaling, and so on.
kTrackModifierTypeClip	2	A QuickDraw clipping region to change the track's shape.
kTrackModifierTypeVolume	3	An 8.8 fixed-point value indicating the relative sound volume. This is used for fading the volume.
kTrackModifierTypeBalance	4	A 16-bit integer indicating the sound balance level. This is used for panning the sound location.

Input identifier	Value	Description
kTrackModifierType- GraphicsMode	5	A graphics mode record (32-bit integer indicating graphics mode, followed by an RGB color) to modify the track's graphics mode for visual fades.
kTrackModifierObjectMatrix	6	A 3x3 transformation matrix to transform an object within the track's location, scaling, and so on.
kTrackModifierObject- GraphicsMode	7	A graphics mode record (32-bit integer indicating graphics mode, followed by an RGB color) to modify an object within the track's graphics mode for visual fades.
kTrackModifierTypeImage	'vide'	Compressed image data for an object within the track. Note that this was kTrackModifierTypeSpriteImage.

If the input is operating on an object within the track (for example, a sprite within a sprite track), an object ID atom must be included in the track input atom to identify the object.

The object ID atom contains the following data elements.

**Size**

A 32-bit integer that specifies the number of bytes in this object ID atom.

**Type**

A 32-bit integer that identifies the atom type; this field must be set to 'obid'.

**Object ID**

A 32-bit integer identifying the object.

## Media Atoms

---

Media atoms describe and define a track's media type and sample data. The media atom contains information that specifies the media type, such as sound or video, the media handler component used to interpret the sample data, the media timescale and track duration, and media-and-track-specific information such as sound volume or graphics mode. It also contains the media data references, which typically specify the file where the sample data is stored, and the sample table atoms, which specify the sample description, duration, and byte offset from the data reference for each media sample.

The media atom has an atom type of 'mdia'. It must contain a media header atom ('mdhd'), and it can contain a handler reference ('hdlr') atom, media information ('minf') atom, and user data ('udta') atom.

**Note:** Do not confuse the media atom ('mdia') with the media *data* atom ('mdat'). The media atom contains only *references* to media data; the media data atom contains the actual media samples.

Figure 2-15 (page 63) shows the layout of a media atom.

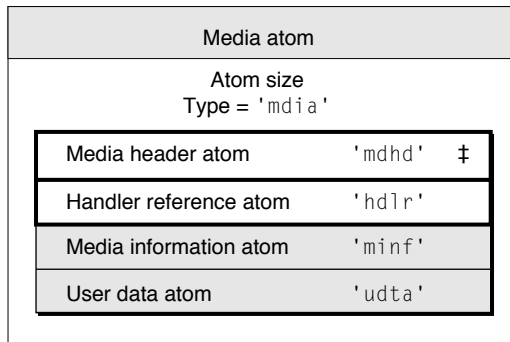
**Figure 2-15** The layout of a media atom

‡ Required atom

Media atoms contain the following data elements.

**Size**

A 32-bit integer that specifies the number of bytes in this media atom.

**Type**

A 32-bit integer that identifies the atom type; this field must be set to 'mdia'.

**Media header atom**

This atom contains the standard media information. See [“Media Header Atoms”](#) (page 63).

**Handler reference atom**

This atom identifies the media handler component that is to be used to interpret the media data. See [“Handler Reference Atoms”](#) (page 65) for more information.

Note that the handler reference atom tells you the kind of media this media atom contains—for example, video or sound. The layout of the media information atom is specific to the media handler that is to interpret the media. [“Media Information Atoms”](#) (page 66) discusses how data may be stored in a media, using the video media format defined by Apple as an example.

**Media information atom**

This atom contains data specific to the media type for use by the media handler component. See [“Media Information Atoms”](#) (page 66).

**User data atom**

See [“User Data Atoms”](#) (page 42).

## Media Header Atoms

---

The media header atom specifies the characteristics of a media, including time scale and duration. The media header atom has an atom type of 'mdhd'.

[Figure 2-16](#) (page 64) shows the layout of the media header atom.

**Figure 2-16** The layout of a media header atom

Media header atom		Bytes
Atom size	4	4
Type = 'mdhd'	4	4
Version	1	1
Flags	3	3
Creation time	4	4
Modification time	4	4
Time scale	4	4
Duration	4	4
Language	2	2
Quality	2	2

Media header atoms contain the following data elements.

**Size**

A 32-bit integer that specifies the number of bytes in this media header atom.

**Type**

A 32-bit integer that identifies the atom type; this field must be set to 'mdhd'.

**Version**

One byte that specifies the version of this header atom.

**Flags**

Three bytes of space for media header flags. Set this field to 0.

**Creation time**

A 32-bit integer that specifies (in seconds since midnight, January 1, 1904) when the media atom was created. It is strongly recommended that this value should be specified using coordinated universal time (UTC).

**Modification time**

A 32-bit integer that specifies (in seconds since midnight, January 1, 1904) when the media atom was changed. It is strongly recommended that this value should be specified using coordinated universal time (UTC).

**Time scale**

A time value that indicates the time scale for this media—that is, the number of time units that pass per second in its time coordinate system.

**Duration**

The duration of this media in units of its time scale.



Language

A 16-bit integer that specifies the language code for this media. See “[Language Code Values](#)” (page 219) for valid language codes.

Quality

A 16-bit integer that specifies the media’s playback quality—that is, its suitability for playback in a given environment.

## Handler Reference Atoms

---

The handler reference atom specifies the media handler component that is to be used to interpret the media’s data. The handler reference atom has an atom type value of 'hdlr'.

Historically, the handler reference atom was also used for data references. However, this use may now be ignored.

The handler atom within a media atom declares the process by which the media data in the stream may be presented, and thus, the nature of the media in a stream. For example, a video handler would handle a video track.

[Figure 2-17](#) (page 65) shows the layout of a handler reference atom.

**Figure 2-17** The layout of a handler reference atom

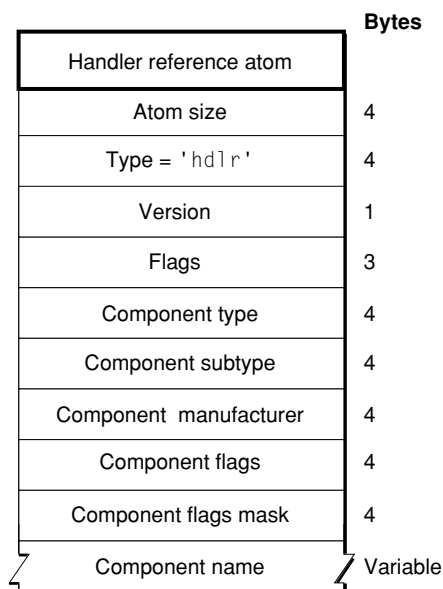

Handler reference atoms contain the following data elements.

Size

A 32-bit integer that specifies the number of bytes in this handler reference atom.

Type

A 32-bit integer that identifies the atom type; this field must be set to 'hdlr'.

## Movie Atoms

## Version

A 1-byte specification of the version of this handler information.

## Flags

A 3-byte space for handler information flags. Set this field to 0.

## Component type

A four-character code that identifies the type of the handler. Only two values are valid for this field: 'mhlr' for media handlers and 'dhlr' for data handlers.

## Component subtype

A four-character code that identifies the type of the media handler or data handler. For media handlers, this field defines the type of data—for example, 'vide' for video data or 'soun' for sound data.

For data handlers, this field defines the data reference type—for example, a component subtype value of 'alis' identifies a file alias.

## Component manufacturer

Reserved. Set to 0.

## Component flags

Reserved. Set to 0.

## Component flags mask

Reserved. Set to 0.

## Component name

A (counted) string that specifies the name of the component—that is, the media handler used when this media was created. This field may contain a zero-length (empty) string.

## Media Information Atoms

---

Media information atoms (defined by the 'minf' atom type) store handler-specific information for a track's media data. The media handler uses this information to map from media time to media data and to process the media data.

These atoms contain information that is specific to the type of data defined by the media. Further, the format and content of media information atoms are dictated by the media handler that is responsible for interpreting the media data stream. Another media handler would not know how to interpret this information.

This section describes the atoms that store media information for the video ('vmhd'), sound ('smhd'), and base ('gmhd') portions of QuickTime movies.

**Note:** “Using Sample Atoms” (page 87) discusses how the video media handler locates samples in a video media.

## Video Media Information Atoms

Video media information atoms are the highest-level atoms in video media. These atoms contain a number of other atoms that define specific characteristics of the video media data. [Figure 2-18](#) (page 67) shows the layout of a video media information atom.

**Figure 2-18** The layout of a media information atom for video

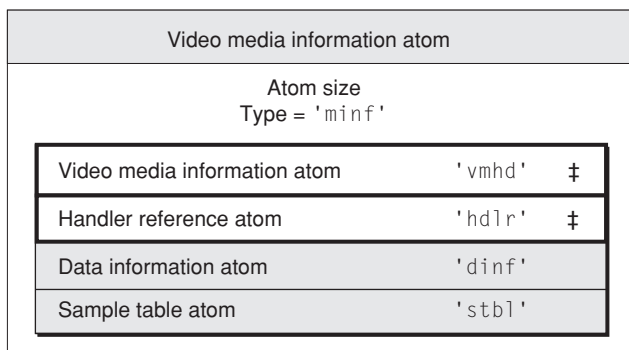

‡ Required atom

The video media information atom contains the following data elements.

### Size

A 32-bit integer that specifies the number of bytes in this video media information atom.

### Type

A 32-bit integer that identifies the atom type; this field must be set to 'minf'.

### Video media information atom

See “[Video Media Information Header Atoms](#)” (page 67).

### Handler reference atom

See “[Handler Reference Atoms](#)” (page 65).

### Data information atom

See “[Data Information Atoms](#)” (page 73).

### Sample table atom

See “[Sample Table Atoms](#)” (page 76).

## Video Media Information Header Atoms

Video media information header atoms define specific color and graphics mode information.

[Figure 2-19](#) (page 68) shows the structure of a video media information header atom.

**Figure 2-19** The layout of a media information header atom for video

Video media information header atom		Bytes
Atom size		4
Type = 'vmhd'		4
Version		1
Flags		3
Graphics mode		2
Opcolor		6

The video media information header atom contains the following data elements.

**Size**

A 32-bit integer that specifies the number of bytes in this video media information header atom.

**Type**

A 32-bit integer that identifies the atom type; this field must be set to 'vmhd'.

**Version**

A 1-byte specification of the version of this video media information header atom.

**Flags**

A 3-byte space for video media information flags. There is one defined flag.

**No lean ahead**

This is a compatibility flag that allows QuickTime to distinguish between movies created with QuickTime 1.0 and newer movies. You should always set this flag to 1, unless you are creating a movie intended for playback using version 1.0 of QuickTime. This flag's value is 0x0001.

**Graphics mode**

A 16-bit integer that specifies the transfer mode. The transfer mode specifies which Boolean operation QuickDraw should perform when drawing or transferring an image from one location to another. See [“Graphics Modes”](#) (page 223) for a list of graphics modes supported by QuickTime.

**Opcolor**

Three 16-bit values that specify the red, green, and blue colors for the transfer mode operation indicated in the graphics mode field.

## Sound Media Information Atoms

---

Sound media information atoms are the highest-level atoms in sound media. These atoms contain a number of other atoms that define specific characteristics of the sound media data. [Figure 2-20](#) (page 69) shows the layout of a sound media information atom.

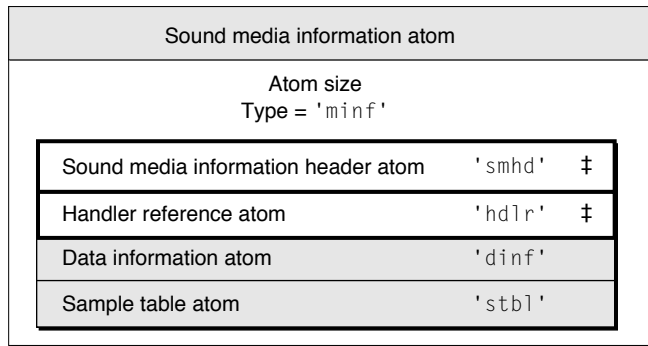
**Figure 2-20** The layout of a media information atom for sound

‡ Required atom

The sound media information atom contains the following data elements.

**Size**

A 32-bit integer that specifies the number of bytes in this sound media information atom.

**Type**

A 32-bit integer that identifies the atom type; this field must be set to 'minf'.

**Sound media information header atom**

See [“Sound Media Information Header Atoms”](#) (page 69).

**Handler reference atom**

See [“Handler Reference Atoms”](#) (page 65).

**Data information atom**

See [“Data Information Atoms”](#) (page 73).

**Sample table atom**

See [“Sample Table Atoms”](#) (page 76).

## Sound Media Information Header Atoms

---

The sound media information header atom (shown in [Figure 2-21](#) (page 70)) stores the sound media’s control information, such as balance.

**Figure 2-21** The layout of a sound media information header atom

	Bytes
Sound media information header atom	
Atom size	4
Type = 'smhd'	4
Version	1
Flags	3
Balance	2
Reserved	2

The sound media information header atom contains the following data elements.

**Size**

A 32-bit integer that specifies the number of bytes in this sound media information header atom.

**Type**

A 32-bit integer that identifies the atom type; this field must be set to 'smhd'.

**Version**

A 1-byte specification of the version of this sound media information header atom.

**Flags**

A 3-byte space for sound media information flags. Set this field to 0.

**Balance**

A 16-bit integer that specifies the sound balance of this sound media. Sound balance is the setting that controls the mix of sound between the two speakers of a computer. This field is normally set to 0. See [“Balance”](#) (page 224) for more information about balance values.

**Reserved**

Reserved for use by Apple. Set this field to 0.

## Base Media Information Atoms

---

The base media information atom (shown in [Figure 2-22](#) (page 71)) stores the media information for media types such as text, MPEG, time code, and music.

Media types that are derived from the base media handler may add other atoms within the base media information atom, as appropriate. At present, the only media type that defines any additional atoms is the timecode media. See [“Timecode Media Information Atom”](#) (page 127) for more information about timecode media.

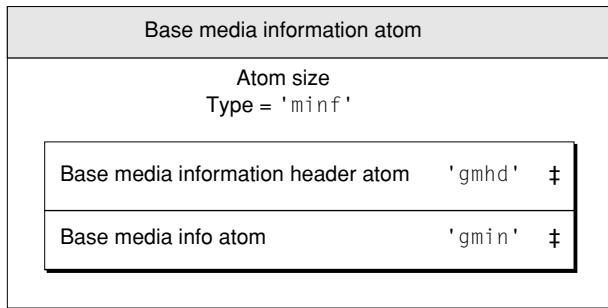
**Figure 2-22** The layout of a base media information atom

‡ Required atom

The base media information atom contains the following data elements.

**Size**

A 32-bit integer that specifies the number of bytes in this base media information atom.

**Type**

A 32-bit integer that identifies the atom type; this field must be set to 'minf'.

**Base media information header atom**

See [“Base Media Information Header Atoms”](#) (page 71).

**Base media info atom**

See [“Base Media Info Atoms”](#) (page 71).

## Base Media Information Header Atoms

---

The base media information header atom indicates that this media information atom pertains to a base media.

The base media information header atom contains the following data elements.

**Size**

A 32-bit integer that specifies the number of bytes in this base media information header atom.

**Type**

A 32-bit integer that identifies the atom type; this field must be set to 'gmhd'.

## Base Media Info Atoms

---

The base media info atom, contained in the base media information atom, defines the media's control information, including graphics mode and balance information.

[Figure 2-23](#) (page 72) shows the layout of the base media info atom.

**Figure 2-23** The layout of a base media info atom

Base media info atom	Bytes
Atom size	4
Type = 'gmin'	4
Version	1
Flags	3
Graphics mode	2
Opcolor	6
Balance	2
Reserved	2

The base media info atom contains the following data elements.

#### Size

A 32-bit integer that specifies the number of bytes in this base media info atom.

#### Type

A 32-bit integer that identifies the atom type; this field must be set to 'gmin'.

#### Version

A 1-byte specification of the version of this base media information header atom.

#### Flags

A 3-byte space for base media information flags. Set this field to 0.

#### Graphics mode

A 16-bit integer that specifies the transfer mode. The transfer mode specifies which Boolean operation QuickDraw should perform when drawing or transferring an image from one location to another. See [“Graphics Modes”](#) (page 223) for more information about graphics modes supported by QuickTime.

#### Opcolor

Three 16-bit values that specify the red, green, and blue colors for the transfer mode operation indicated in the graphics mode field.

#### Balance

A 16-bit integer that specifies the sound balance of this media. Sound balance is the setting that controls the mix of sound between the two speakers of a computer. This field is normally set to 0. See [“Balance”](#) (page 224) for more information about balance values.

#### Reserved

Reserved for use by Apple. Set this field to 0.



## Data Information Atoms

The handler reference atom (described in “[Handler Reference Atoms](#)” (page 65)) contains information specifying the data handler component that provides access to the media data. The data handler component uses the data information atom to interpret the media’s data. Data information atoms have an atom type value of 'dinf'.

[Figure 2-24](#) (page 73) shows the layout of the data information atom.

**Figure 2-24** The layout of a data information atom

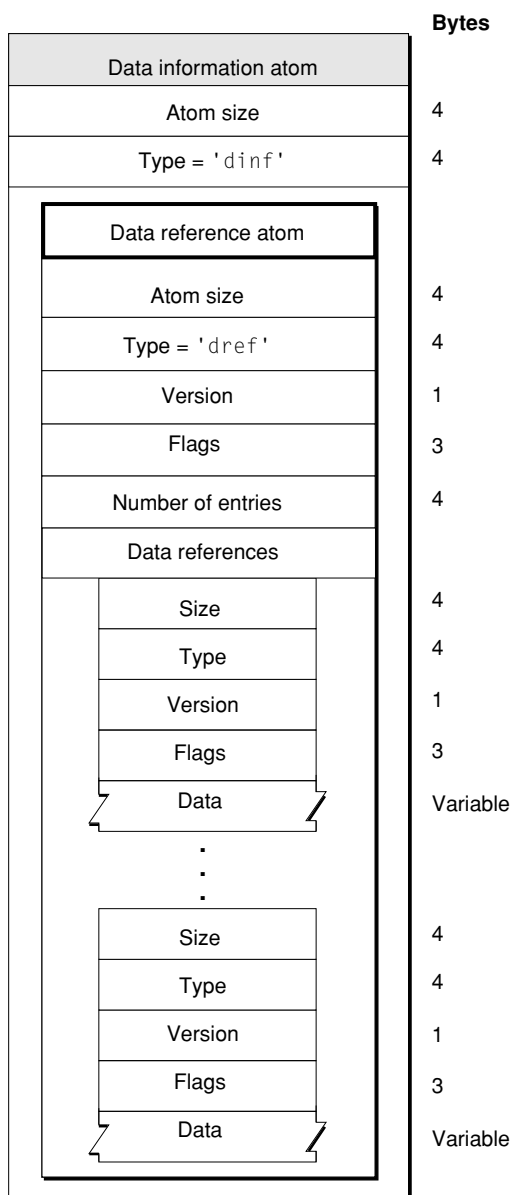

The data information atom contains the following data elements.

## Movie Atoms

## Size

A 32-bit integer that specifies the number of bytes in this data information atom.

## Type

A 32-bit integer that identifies the atom type; this field must be set to 'dinf'.

## Data reference atom

See “[Data Reference Atoms](#)” (page 74).

## Data Reference Atoms

---

Data reference atoms contain tabular data that instructs the data handler component how to access the media's data. [Figure 2-24](#) (page 73) shows the data reference atom.

The data reference atom contains the following data elements.

## Size

A 32-bit integer that specifies the number of bytes in this data reference atom.

## Type

A 32-bit integer that identifies the atom type; this field must be set to 'dref'.

## Version

A 1-byte specification of the version of this data reference atom.

## Flags

A 3-byte space for data reference flags. Set this field to 0.

## Number of entries

A 32-bit integer containing the count of data references that follow.

## Data references

An array of data references.

Each data reference is formatted like an atom and contains the following data elements.

## Size

A 32-bit integer that specifies the number of bytes in the data reference.

## Type

A 32-bit integer that specifies the type of the data in the data reference. [Table 2-4](#) (page 75) lists valid type values.

## Version

A 1-byte specification of the version of the data reference.

## Flags

A 3-byte space for data reference flags. There is one defined flag.

## Self reference

This flag indicates that the media's data is in the same file as the movie atom. On the Macintosh, and other file systems with multifork files, set this flag to 1 even if the data resides in a different fork from the movie atom. This flag's value is 0x0001.

## Data

The data reference information.

[Table 2-4](#) (page 75) shows the currently defined data reference types that may be stored in a header atom.

**Table 2-4** Data reference types

Data reference type	Description
'alis'	Data reference is a Macintosh alias. An alias contains information about the file, including its full path name.
'rsrc'	Data reference is a Macintosh alias. Appended to the end of the alias is the resource type (stored as a 32-bit integer) and ID (stored as a 16-bit signed integer) to use within the specified file.
'url '	A C string that specifies a URL. There may be additional data after the C string.

## Sample Atoms

---

QuickTime stores media data in samples. A sample is a single element in a sequence of time-ordered data. Samples are stored in the media, and they may have varying durations.

Samples are stored in a series of chunks in a media. Chunks are a collection of data samples in a media that allow optimized data access. A chunk may contain one or more samples. Chunks in a media may have different sizes, and the individual samples within a chunk may have different sizes from one another, as shown in [Figure 2-25](#) (page 76).

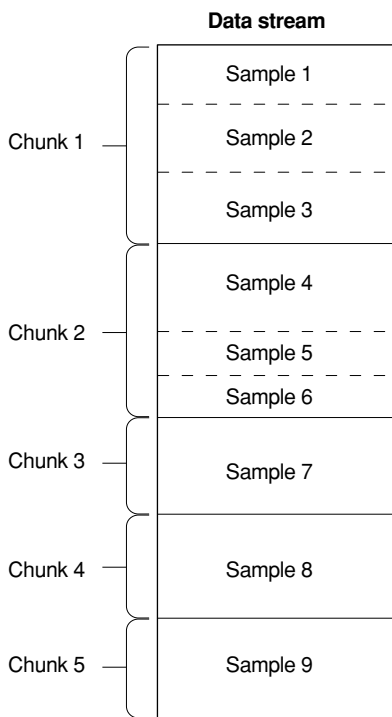
**Figure 2-25** Samples in a media

One way to describe a sample is to use a sample table atom. The sample table atom acts as a storehouse of information about the samples and contains a number of different types of atoms. The various atoms contain information that allows the media handler to parse the samples in the proper order. This approach enforces an ordering of the samples without requiring that the sample data be stored sequentially with respect to movie time in the actual data stream.

The next section discusses the sample table atom. Subsequent sections discuss each of the atoms that may reside in a sample table atom.

## Sample Table Atoms

---

The sample table atom contains information for converting from media time to sample number to sample location. This atom also indicates how to interpret the sample (for example, whether to decompress the video data and, if so, how). This section describes the format and content of the sample table atom.

The sample table atom has an atom type of 'stbl'. It can contain the sample description atom, the time-to-sample atom, the sync sample atom, the sample-to-chunk atom, the sample size atom, the chunk offset atom, and the shadow sync atom.

The sample table atom contains all the time and data indexing of the media samples in a track. Using tables, it is possible to locate samples in time, determine their type, and determine their size, container, and offset into that container.

If the track that contains the sample table atom references no data, then the sample table atom does not need to contain any child atoms (not a very useful media track).

If the track that the sample table atom is contained in does reference data, then the following child atoms are required: sample description, sample size, sample to chunk, and chunk offset. All of the subtables of the sample table use the same total sample count.

The sample description atom must contain at least one entry. A sample description atom is required because it contains the data reference index field that indicates which data reference atom to use to retrieve the media samples. Without the sample description, it is not possible to determine where the media samples are stored. The sync sample atom is optional. If the sync sample atom is not present, all samples are implicitly sync samples.

Figure 2-26 (page 77) shows the layout of the sample table atom.

**Figure 2-26** The layout of a sample table atom

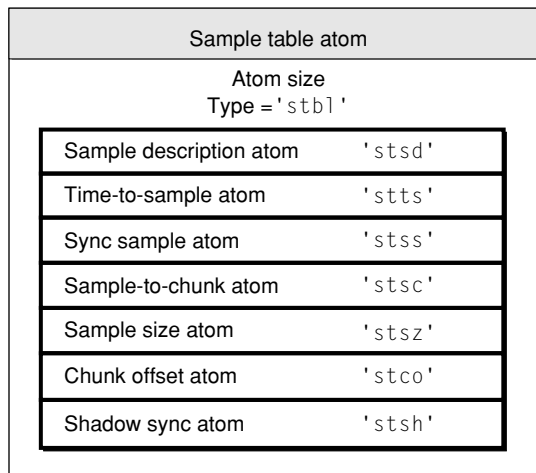

The sample table atom contains the following data elements.

#### Size

A 32-bit integer that specifies the number of bytes in this sample table atom.

#### Type

A 32-bit integer that identifies the atom type; this field must be set to 'stbl'.

#### Sample description atom

See [“Sample Description Atoms”](#) (page 78).

#### Time-to-sample atom

See [“Time-to-Sample Atoms”](#) (page 79).

#### Sync sample atom

See [“Sync Sample Atoms”](#) (page 81).

#### Sample-to-chunk atom

See [“Sample-to-Chunk Atoms”](#) (page 83).

#### Sample size atom

See [“Sample Size Atoms”](#) (page 84).

#### Chunk offset atom

See [“Chunk Offset Atoms”](#) (page 86).

## Shadow sync atom

Reserved for future use.

## Sample Description Atoms

---

The sample description atom stores information that allows you to decode samples in the media. The data stored in the sample description varies, depending on the media type. For example, in the case of video media, the sample descriptions are image description structures. The sample description information for each media type is explained in [“Media Data Atom Types”](#) (page 99)

[Figure 2-27](#) (page 78) shows the layout of the sample description atom.

**Figure 2-27** The layout of a sample description atom

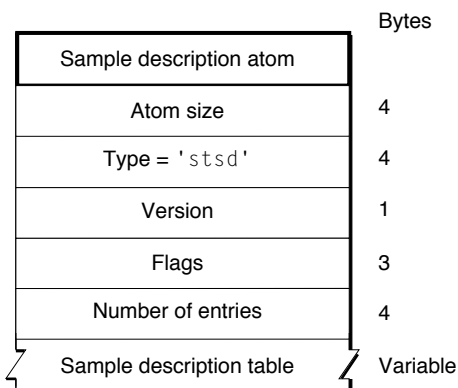

The sample description atom has an atom type of 'stsd'. The sample description atom contains a table of sample descriptions. A media may have one or more sample descriptions, depending upon the number of different encoding schemes used in the media and on the number of files used to store the data. The sample-to-chunk atom identifies the sample description for each sample in the media by specifying the index into this table for the appropriate description (see [“Sample-to-Chunk Atoms”](#) (page 83)).

The sample description atom contains the following data elements.

## Size

A 32-bit integer that specifies the number of bytes in this sample description atom.

## Type

A 32-bit integer that identifies the atom type; this field must be set to 'stsd'.

## Version

A 1-byte specification of the version of this sample description atom.

## Flags

A 3-byte space for sample description flags. Set this field to 0.

## Number of entries

A 32-bit integer containing the number of sample descriptions that follow.

**Sample description table**

An array of sample descriptions. For details, see [“General Structure of a Sample Description”](#) (page 79).

## General Structure of a Sample Description

---

While the exact format of the sample description varies by media type, the first four fields of every sample description are the same.

**Sample description size**

A 32-bit integer indicating the number of bytes in the sample description.

**Data format**

A 32-bit integer indicating the format of the stored data. This depends on the media type, but is usually either the compression format or the media type.

**Reserved**

Six bytes that must be set to 0.

**Data reference index**

A 16-bit integer that contains the index of the data reference to use to retrieve data associated with samples that use this sample description. Data references are stored in data reference atoms.

These four fields may be followed by additional data specific to the media type and data format. See [“Media Data Atom Types”](#) (page 99) for additional details regarding specific media types and media formats.

## Time-to-Sample Atoms

---

Time-to-sample atoms store duration information for a media’s samples, providing a mapping from a time in a media to the corresponding data sample. The time-to-sample atom has an atom type of 'stts'.

You can determine the appropriate sample for any time in a media by examining the time-to-sample atom table, which is contained in the time-to-sample atom.

The atom contains a compact version of a table that allows indexing from time to sample number. Other tables provide sample sizes and pointers from the sample number. Each entry in the table gives the number of consecutive samples with the same time delta, and the delta of those samples. By adding the deltas, a complete time-to-sample map can be built.

The atom contains time deltas:  $DT(n+1) = DT(n) + STTS(n)$  where  $STTS(n)$  is the (uncompressed) table entry for sample  $n$  and  $DT$  is the display time for sample  $(n)$ . The sample entries are ordered by time stamps; therefore, the deltas are all nonnegative. The  $DT$  axis has a zero origin;  $DT(i) = \text{SUM}(\text{for } j=0 \text{ to } i-1 \text{ of } \text{delta}(j))$ , and the sum of all deltas gives the length of the media in the track (not mapped to the overall time scale, and not considering any edit list). The edit list atom provides the initial  $DT$  value if it is nonempty (nonzero).

[Figure 2-28](#) (page 80) shows the layout of the time-to-sample atom.

**Figure 2-28** The layout of a time-to-sample atom

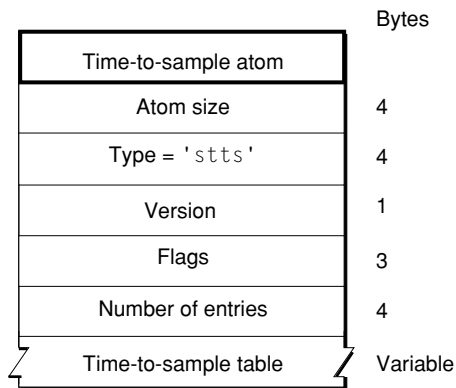

The time-to-sample atom contains the following data elements.

**Size**

A 32-bit integer that specifies the number of bytes in this time-to-sample atom.

**Type**

A 32-bit integer that identifies the atom type; this field must be set to 'stts'.

**Version**

A 1-byte specification of the version of this time-to-sample atom.

**Flags**

A 3-byte space for time-to-sample flags. Set this field to 0.

**Number of entries**

A 32-bit integer containing the count of entries in the time-to-sample table.

**Time-to-sample table**

A table that defines the duration of each sample in the media. Each table entry contains a count field and a duration field. The structure of the time-to-sample table is shown in [Figure 2-29](#) (page 80).

**Figure 2-29** The layout of a time-to-sample table entry

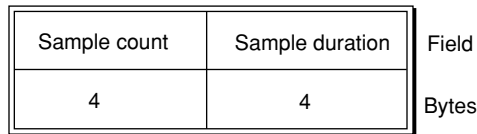

You define a time-to-sample table entry by specifying these fields:

**Sample count**

A 32-bit integer that specifies the number of consecutive samples that have the same duration.

**Sample duration**

A 32-bit integer that specifies the duration of each sample.



Entries in the table describe samples according to their order in the media and their duration. If consecutive samples have the same duration, a single table entry can be used to define more than one sample. In these cases, the count field indicates the number of consecutive samples that have the same duration. For example, if a video media has a constant frame rate, this table would have one entry and the count would be equal to the number of samples.

Figure 2-30 (page 81) presents an example of a time-to-sample table that is based on the chunked media data shown in Figure 2-25 (page 76). That data stream contains a total of nine samples that correspond in count and duration to the entries of the table shown here. Even though samples 4, 5, and 6 are in the same chunk, sample 4 has a duration of 3, and samples 5 and 6 have a duration of 2.

**Figure 2-30** An example of a time-to-sample table

Sample count	Sample duration
4	3
2	1
3	2

## Sync Sample Atoms

---

The sync sample atom identifies the key frames in the media. In a media that contains compressed data, key frames define starting points for portions of a temporally compressed sequence. The key frame is self-contained—that is, it is independent of preceding frames. Subsequent frames may depend on the key frame.

The sync sample atom provides a compact marking of the random access points within a stream. The table is arranged in strictly increasing order of sample number. If this table is not present, every sample is implicitly a random access point.

Sync sample atoms have an atom type of 'stss'. The sync sample atom contains a table of sample numbers. Each entry in the table identifies a sample that is a key frame for the media. If no sync sample atom exists, then all the samples are key frames.

Figure 2-31 (page 82) shows the layout of a sync sample atom.

**Figure 2-31** The layout of a sync sample atom

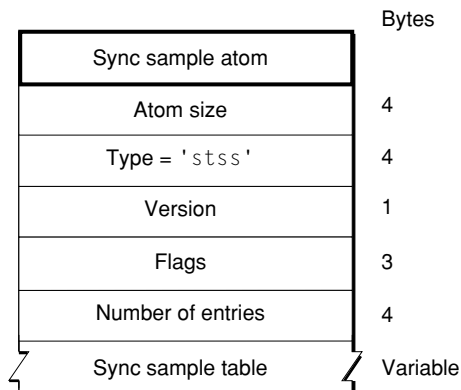

The sync sample atom contains the following data elements.

**Size**

A 32-bit integer that specifies the number of bytes in this sync sample atom.

**Type**

A 32-bit integer that identifies the atom type; this field must be set to 'stss'.

**Version**

A 1-byte specification of the version of this sync sample atom.

**Flags**

A 3-byte space for sync sample flags. Set this field to 0.

**Number of entries**

A 32-bit integer containing the count of entries in the sync sample table.

**Sync sample table**

A table of sample numbers; each sample number corresponds to a key frame. [Figure 2-32](#) (page 82) shows the layout of the sync sample table.

**Figure 2-32** The layout of a sync sample table

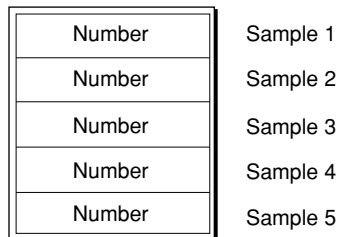

## Sample-to-Chunk Atoms

As samples are added to a media, they are collected into chunks that allow optimized data access. A chunk contains one or more samples. Chunks in a media may have different sizes, and the samples within a chunk may have different sizes. The sample-to-chunk atom stores chunk information for the samples in a media.

Sample-to-chunk atoms have an atom type of 'stsc'. The sample-to-chunk atom contains a table that maps samples to chunks in the media data stream. By examining the sample-to-chunk atom, you can determine the chunk that contains a specific sample.

Figure 2-33 (page 83) shows the layout of the sample-to-chunk atom.

**Figure 2-33** The layout of a sample-to-chunk atom

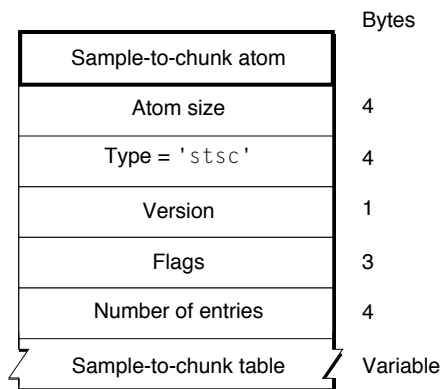

The sample-to-chunk atom contains the following data elements.

### Size

A 32-bit integer that specifies the number of bytes in this sample-to-chunk atom.

### Type

A 32-bit integer that identifies the atom type; this field must be set to 'stsc'.

### Version

A 1-byte specification of the version of this sample-to-chunk atom.

### Flags

A 3-byte space for sample-to-chunk flags. Set this field to 0.

### Number of entries

A 32-bit integer containing the count of entries in the sample-to-chunk table.

### Sample-to-chunk table

A table that maps samples to chunks. Figure 2-34 (page 84) shows the structure of an entry in a sample-to-chunk table. Each sample-to-chunk atom contains such a table, which identifies the chunk for each sample in a media. Each entry in the table contains a first chunk field, a samples per chunk field, and a sample description ID field. From this information, you can ascertain where samples reside in the media data.

**Figure 2-34** The layout of a sample-to-chunk table entry

First chunk	Samples per chunk	Sample description ID	Fields
4	4	4	Bytes

You define a sample-to-chunk table entry by specifying the following data elements.

**First chunk**

The first chunk number using this table entry.

**Samples per chunk**

The number of samples in each chunk.

**Sample description ID**

The identification number associated with the sample description for the sample. For details on sample description atoms, see [“Sample Description Atoms”](#) (page 78).

[Figure 2-35](#) (page 84) shows an example of a sample-to-chunk table that is based on the data stream shown in [Figure 2-25](#) (page 76).

**Figure 2-35** An example of a sample-to-chunk table

First chunk	Samples per chunk	Sample description ID
1	3	23
3	1	23
5	1	24

Each table entry corresponds to a set of consecutive chunks, each of which contains the same number of samples. Furthermore, each of the samples in these chunks must use the same sample description. Whenever the number of samples per chunk or the sample description changes, you must create a new table entry. If all the chunks have the same number of samples per chunk and use the same sample description, this table has one entry.

## Sample Size Atoms

---

You use sample size atoms to specify the size of each sample in the media. Sample size atoms have an atom type of 'stsz'.

The sample size atom contains the sample count and a table giving the size of each sample. This allows the media data itself to be unframed. The total number of samples in the media is always indicated in the sample count. If the default size is indicated, then no table follows.

[Figure 2-36](#) (page 85) shows the layout of the sample size atom.

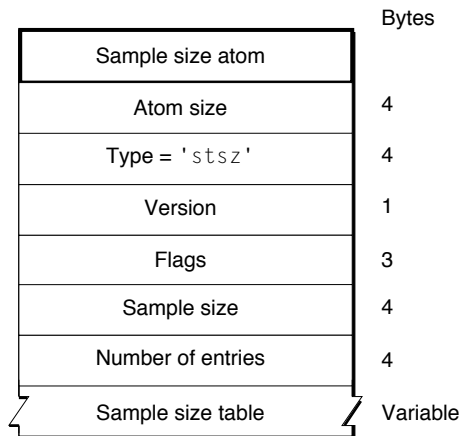
**Figure 2-36** The layout of a sample size atom

The sample size atom contains the following data elements.

**Size**

A 32-bit integer that specifies the number of bytes in this sample size atom.

**Type**

A 32-bit integer that identifies the atom type; this field must be set to 'stsz'.

**Version**

A 1-byte specification of the version of this sample size atom.

**Flags**

A 3-byte space for sample size flags. Set this field to 0.

**Sample size**

A 32-bit integer specifying the sample size. If all the samples are the same size, this field contains that size value. If this field is set to 0, then the samples have different sizes, and those sizes are stored in the sample size table.

**Number of entries**

A 32-bit integer containing the count of entries in the sample size table.

**Sample size table**

A table containing the sample size information. The sample size table contains an entry for every sample in the media's data stream. Each table entry contains a size field. The size field contains the size, in bytes, of the sample in question. The table is indexed by sample number—the first entry corresponds to the first sample, the second entry is for the second sample, and so on.

[Figure 2-37](#) (page 86) shows a sample size table.

**Figure 2-37** An example of a sample size table

Size	Sample 1
Size	Sample 2
Size	Sample 3
Size	Sample 4
Size	Sample 5

## Chunk Offset Atoms

Chunk offset atoms identify the location of each chunk of data in the media’s data stream. Chunk offset atoms have an atom type of 'stco'.

The chunk-offset table gives the index of each chunk into the containing file. There are two variants, permitting the use of 32-bit or 64-bit offsets. The latter is useful when managing very large movies. Only one of these variants occurs in any single instance of a sample table atom.

Note that offsets are file offsets, not the offset into any atom within the file (for example, a 'mdat' atom). This permits referring to media data in files without any atom structure. However, be careful when constructing a self-contained QuickTime file with its metadata (movie atom) at the front because the size of the movie atom affects the chunk offsets to the media data.

**Note:** The sample table atom can contain a 64-bit chunk offset atom (STChunkOffset64AID = 'co64'). When this atom appears, it is used in place of the original chunk offset atom, which can contain only 32-bit offsets. When QuickTime writes movie files, it uses the 64-bit chunk offset atom only if there are chunks that use the high 32-bits of the chunk offset. Otherwise, the original 32-bit chunk offset atom is used to ensure compatibility with previous versions of QuickTime.

Figure 2-38 (page 86) shows the layout of a chunk offset atom.

**Figure 2-38** The layout of a chunk offset atom

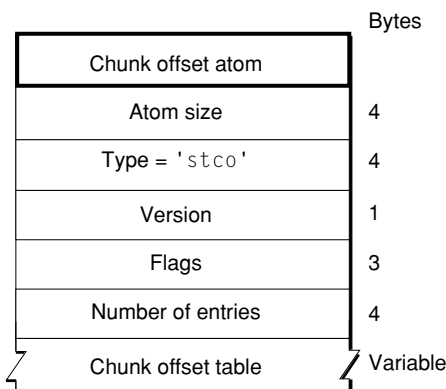

The chunk offset atom contains the following data elements.

## Movie Atoms

## Size

A 32-bit integer that specifies the number of bytes in this chunk offset atom.

## Type

A 32-bit integer that identifies the atom type; this field must be set to 'stco'.

## Version

A 1-byte specification of the version of this chunk offset atom.

## Flags

A 3-byte space for chunk offset flags. Set this field to 0.

## Number of entries

A 32-bit integer containing the count of entries in the chunk offset table.

## Chunk offset table

A chunk offset table consisting of an array of offset values. There is one table entry for each chunk in the media. The offset contains the byte offset from the beginning of the data stream to the chunk. The table is indexed by chunk number—the first table entry corresponds to the first chunk, the second table entry is for the second chunk, and so on.

Figure 2-39 (page 87) shows an example of a chunk offset table.

**Figure 2-39** An example of a chunk offset table

Offset	Chunk 1
Offset	Chunk 2
Offset	Chunk 3
Offset	Chunk 4
Offset	Chunk 5

## Using Sample Atoms

---

This section presents examples using the atoms just described. These examples are intended to help you understand the relationships between these atoms.

The first section, “[Finding a Sample](#)” (page 87), describes the steps that the video media handler uses to find the sample that contains the media data for a particular time in a media. The second section, “[Finding a Key Frame](#)” (page 88), describes the steps that the video media handler uses to find an appropriate key frame for a specific time in a movie.

### Finding a Sample

---

When QuickTime displays a movie or track, it “tells” the appropriate media handler to access the media data for a particular time. The media handler must correctly interpret the data stream to retrieve the requested data. In the case of video media, the media handler traverses several atoms to find the location and size of a sample for a given media time.

The media handler performs the following steps:

1. Determines the time in the media time coordinate system.
2. Examines the time-to-sample atom to determine the sample number that contains the data for the specified time.
3. Scans the sample-to-chunk atom to discover which chunk contains the sample in question.
4. Extracts the offset to the chunk from the chunk offset atom.
5. Finds the offset within the chunk and the sample's size by using the sample size atom.

### Finding a Key Frame

---

Finding a key frame for a specified time in a movie is slightly more complicated than finding a sample for a specified time. The media handler must use the sync sample atom and the time-to-sample atom together in order to find a key frame.

The media handler performs the following steps:

1. Examines the time-to-sample atom to determine the sample number that contains the data for the specified time.
2. Scans the sync sample atom to find the key frame that precedes the sample number chosen in step 1.
3. Scans the sample-to-chunk atom to discover which chunk contains the key frame.
4. Extracts the offset to the chunk from the chunk offset atom.
5. Finds the offset within the chunk and the sample's size by using the sample size atom.

## Compressed Movie Resources

---

Most QuickTime movies have metadata in addition to their media data. Media data can be compressed using a variety of video and sound compression algorithms. Beginning with QuickTime 3, it also became possible to compress the metadata—more commonly known as the movie resource. However, the movie resource cannot be compressed by means of a lossy compression algorithm because it contains critical information, such as the video and audio compression types used, individual frame offsets, and timing information. To compress the movie resource, therefore, lossless data compression algorithms must be used.

Compressing movie resources using data compression typically reduces the size of the movie resource by 50% or more. For QuickTime movies that are streamed over the Internet, this can substantially reduce the startup latency of the movie, and therefore has a number of distinct advantages.



## Allowing QuickTime to Compress the Movie Resource

---

Most application developers won't need to know the details of how movie resources are compressed. The Movie Toolbox `FlattenMovie` and `FlattenMovieData` functions compress the movie resource if so requested by the application. To accomplish this, applications only need to set the `flattenCompressMovieResource` flag when calling either function. The QuickTime movie export component also provides users with the option of compressing the movie resource when exporting or creating a new movie through export.

## Structure of a Compressed Movie Resource

---

A compressed movie resource, similar to an uncompressed movie resource, is made up of a group of QuickTime atoms arranged in a hierarchy.

Like an uncompressed movie resource, the outermost atom is a movie atom. Within the movie atom, there is a single compressed movie atom, which contains all other required atoms. The compressed movie atom has two subatoms. The first is a data compression atom, which contains a single 32-bit integer that identifies what lossless data compression algorithm was used to compress the movie resource. The second child atom is the compressed movie data, which contains the compressed movie resource itself. The first 32-bit integer in the compressed movie data atom indicates the uncompressed size of the movie resource, and then the compressed movie resource data follows.

The contents of a complete compressed movie are shown in [Table 2-5](#) (page 89). The constants that define the atom types are defined in `MoviesFormat.h`. The four-character codes for each atom type are also shown.

**Table 2-5** Contents of complete compressed movie

Atom type	Four-character code
Movie	'moov'
Compressed movie	'cmov'
Data compression atom	'dcom'
Compressed movie data	'cmvd'
32-bit integer	Uncompressed size

## Reference Movies

---

A QuickTime movie can act as a container for a set of alternate movies that should be displayed under specified conditions. One of these movies may be contained within the same file; any others are included by reference.

For example, a QuickTime movie can contain a list of references to movies having different data rates, allowing an application to choose the best-looking movie that can play smoothly as it downloads over the Internet, based on the user's connection speed.

A movie that contains references to alternate movies is called a reference movie.

A reference movie contains a reference movie atom ('rmra') at the top level of the movie atom. The movie atom may also contain a movie header atom, or it may contain the reference movie atom alone.

**Figure 2-40** A movie atom containing a 'rmra' atom instead of a 'mvhd' atom

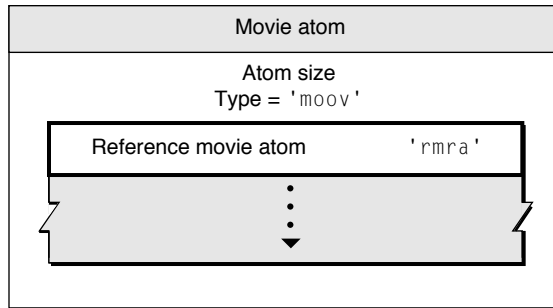

The reference movie atom contains one or more reference movie descriptor atoms, each of which describes an alternate movie.

Each reference movie descriptor atom contains a data reference atom, which specifies the location of a movie.

**Note:** Movie locations are specified using QuickTime data references. QuickTime supports multiple types of data reference, but alternate movies are generally specified using data reference types of either url ('url ') or file alias ('alis').

A reference movie descriptor atom may contain other atoms that specify the movie's system requirements and the movie quality. If so, there will be an atom of an appropriate type for each requirement that must be met for the movie to play, and there may be a quality atom as well.

Applications should play the highest-quality movie whose requirements are met by the user's system. If the data reference to the selected movie cannot be resolved—because the file cannot be found, for example—the application should recursively attempt to play the next-highest-quality movie until it succeeds or has exhausted the list of movies whose requirements are met.

If a movie contains both a reference movie atom and a movie header atom, applications should play the appropriate movie indicated by the reference movie atom.

If the user's system does not meet any of the alternate movies' criteria, or none of the qualifying data references can be resolved, applications should play the movie defined in the movie header atom. (The movie defined in the movie header atom can also be indicated by one of the alternate movie references.)

The movie header atom is sometimes used to provide a fallback movie for applications that can play older QuickTime movies but do not understand reference movies.

When parsing a reference movie, the reader should treat the URL or file reference in the reference movie atom as a new starting point, making no assumptions that the reference is a valid URL, or an existing file, or a well-formed and playable QuickTime movie.

## Reference Movie Atom

---

A reference movie atom contains references to one or more movies. It can optionally contain a list of system requirements in order for each movie to play, and a quality rating for each movie. It is typically used to specify a list of alternate movies to be played under different conditions.

A reference movie atom's parent is always a movie atom ('moov'). Only one reference movie atom is allowed in a given movie atom.

**Figure 2-41** A 'rmra' atom with multiple 'rmda' atoms

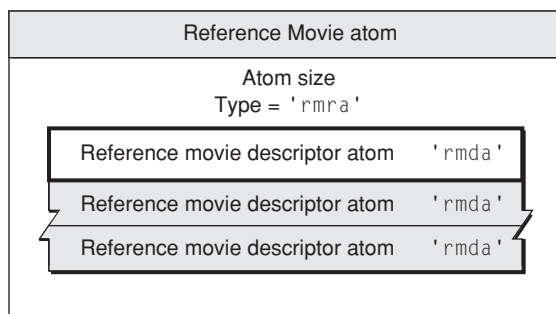

A reference movie atom may contain the following fields:

### Size

The number of bytes in this reference movie atom.

### Type

The type of this atom; this field must be set to 'rmra'.

### Reference movie descriptor atom

A reference movie atom must contain at least one reference movie descriptor atom, and typically contains more than one. See [“Reference Movie Descriptor Atom”](#) (page 91) for more information.

## Reference Movie Descriptor Atom

---

Each reference movie descriptor atom contains other atoms that describe where a particular movie can be found, and optionally what the system requirements are to play that movie, as well as an optional quality rating for that movie.

A reference movie descriptor atom's parent is always a movie reference atom ('rmra'). Multiple reference movie descriptor atoms are allowed in a given movie reference atom, and more than one is usually present.

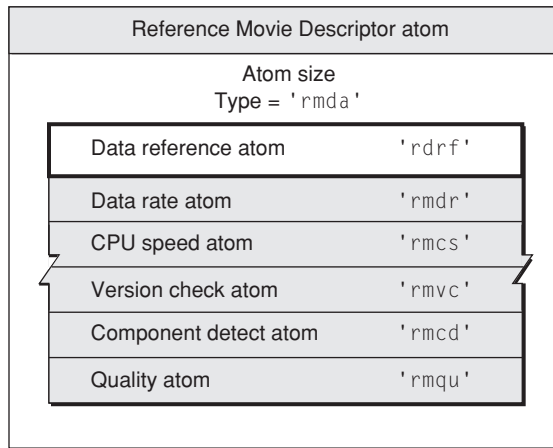
**Figure 2-42** Reference movie descriptor atom

A reference movie descriptor atom may contain the following fields:

**Size**

The number of bytes in this reference movie descriptor atom.

**Type**

The type of this atom; this field must be set to 'rmda'.

**Data reference atom**

Each reference movie atom must contain exactly one data reference atom. See [“Data Reference Atoms”](#) (page 74) for more information.

**Data rate atom**

A reference movie atom may contain an optional data rate atom. Only one data rate atom can be present. See [“Data Rate Atom”](#) (page 93) for more information.

**CPU speed atom**

A reference movie atom may contain an optional CPU speed atom. Only one CPU speed atom can be present. See [“CPU Speed Atom”](#) (page 94) for more information.

**Version check atom**

A reference movie atom may contain an optional version check atom. Multiple version check atoms can be present. See [“Version Check Atom”](#) (page 94) for more information.

**Component detect atom**

A reference movie atom may contain an optional component detect atom. Multiple component detect atoms can be present. See [“Component Detect Atom”](#) (page 95) for more information.

**Quality atom**

A reference movie atom may contain an optional quality atom. Only one quality atom can be present. See [“Quality Atom”](#) (page 97) for more information.

## Data Reference Atom

---

A data reference atom contains the information necessary to locate a movie, or a stream or file that QuickTime can play, typically in the form of a URL or a file alias.

## Movie Atoms

Only one data reference atom is allowed in a given movie reference descriptor atom.

A data reference atom may contain the following fields:

## Size

The number of bytes in this data reference atom.

## Type

The type of this atom; this field must be set to 'rdrf'.

## Flags

A 32-bit integer containing flags. One flag is currently defined: movie is self-contained. If the least-significant bit is set to 1, the movie is self-contained. This requires that the parent movie contain a movie header atom as well as a reference movie atom. In other words, the current 'moov' atom must contain both a 'rmra' atom and a 'mvhd' atom. To resolve this data reference, an application uses the movie defined in the movie header atom, ignoring the remainder of the fields in this data reference atom, which are used only to specify external movies.

## Data reference type

The data reference type. A value of 'alis' indicates a file system alias record. A value of 'url' indicates a string containing a uniform resource locator. Note that the fourth character in 'url' is an ASCII blank (0x20).

## Data reference size

The size of the data reference in bytes, expressed as a 32-bit integer.

## Data reference

A data reference to a QuickTime movie, or to a stream or file that QuickTime can play. If the reference type is 'alis' this field contains the contents of an AliasHandle. If the reference type is 'url' this field contains a null-terminated string that can be interpreted as a URL. The URL can be absolute or relative, and can specify any protocol that QuickTime supports, including http://, ftp://, rtsp://, file://, and data:.

## Data Rate Atom

---

A data rate atom specifies the minimum data rate required to play a movie. This is normally compared to the connection speed setting in the user's QuickTime Settings control panel. Applications should play the movie with the highest data rate less than or equal to the user's connection speed. If the connection speed is slower than any movie's data rate, applications should play the movie with the lowest data rate. The movie with the highest data rate is assumed to have the highest quality.

Only one data rate atom is allowed in a given reference movie descriptor atom.

A data rate atom may contain the following fields:

## Size

The number of bytes in this data rate atom.

## Type

The type of this atom; this field must be set to 'rmdr'.

## Flags

A 32-bit integer that is currently always 0.

**Data rate**

The required data rate in bits per second, expressed as a 32-bit integer.

## CPU Speed Atom

---

A CPU speed atom specifies the minimum computing power needed to display a movie. QuickTime performs an internal test to determine the speed of the user's computer.

This is not a simple measurement of clock speed—it is a measurement of performance for QuickTime-related operations. Speed is expressed as a relative value between 100 and  $2^{31}$ , in multiples of 100.

**Note:** Typical scores might range from a minimum score of 100, which would describe a computer as slow as, or slower than, a 166 MHz Pentium or 120 MHz PowerPC, to a maximum score of 600 for a 500 MHz Pentium III or 400 MHz G4 PowerPC. A computer with a graphics accelerator and a Gigahertz clock speed might score as high as 1000. Future computers will score higher.

Applications should play the movie with the highest specified CPU speed that is less than or equal to the user's speed. If the user's speed is lower than any movie's CPU speed, applications should play the movie with the lowest CPU speed requirement. The movie with the highest CPU speed is assumed to be the highest quality.

Only one CPU speed atom is allowed in a given reference movie descriptor atom.

A CPU speed atom may contain the following fields:

**Size**

The number of bytes in this CPU speed atom.

**Type**

The type of this atom; this field must be set to 'rmcs'.

**Flags**

A 32-bit integer that is currently always 0.

**CPU speed**

A relative ranking of required computer speed, expressed as a 32-bit integer divisible by 100, with larger numbers indicating higher speed.

## Version Check Atom

---

A version check atom specifies a software package, such as QuickTime or QuickTime VR, and the version of that package needed to display a movie. The package is specified using a Macintosh Gestalt type, such as 'qtim' for QuickTime (QuickTime provides support for these Gestalt tests in the Windows computing environment).

You can specify a minimum required version to be returned by the Gestalt check, or you can require that a specific value be returned after performing a binary AND operation on the Gestalt bitfield and a mask.

## Movie Atoms

Multiple version check atoms are allowed within a given reference movie descriptor atom. Applications should not attempt to play a movie unless all version checks are successful.

A version check atom may contain the following fields:

## Size

The number of bytes in this version check atom.

## Type

The type of this atom; this field must be set to 'rmvc'.

## Flags

A 32-bit integer that is currently always 0.

## Software package

A 32-bit Gestalt type, such as 'qtim', specifying the software package to check for.

## Version

An unsigned 32-bit integer containing either the minimum required version or the required value after a binary AND operation.

## Mask

The mask for a binary AND operation on the Gestalt bitfield.

## Check type

The type of check to perform, expressed as 16-bit integer. Set to 0 for a minimum version check, set to 1 for a required value after a binary AND of the Gestalt bitfield and the mask.

## Component Detect Atom

---

A component detect atom specifies a QuickTime component, such as a particular video decompressor, required to play the movie. The component type, subtype, and other required attributes can be specified, as well as a minimum version.

Multiple component detect atoms are allowed within a given reference movie descriptor atom. Applications should not attempt to play a movie unless at least the minimum versions of all required components are present.

A component detect atom may contain the following fields:

## Size

The number of bytes in this component detect atom.

## Type

The type of this atom; this field must be set to 'rmdc'.

## Flags

A 32-bit integer that is currently always 0.

## Component description

A component description record. For details, see [“Component Description Record”](#) (page 96).

**Minimum version**

An unsigned 32-bit integer containing the minimum required version of the specified component.

## Component Description Record

---

Describes a class of components by their attributes. Fields that are set to 0 are treated as “don’t care.”

```
struct ComponentDescription {
    OSType      componentType;
    OSType      componentSubType;
    OSType      componentManufacturer;
    unsigned long componentFlags;
    unsigned long componentFlagsMask;
};
```

**componentType**

A four-character code that identifies the type of component.

**componentSubType**

A four-character code that identifies the subtype of the component. For example, the subtype of an image compressor component indicates the compression algorithm employed by the compressor. A value of 0 matches any subtype.

**componentManufacturer**

A four-character code that identifies the manufacturer of the component. Components provided by Apple have a manufacturer value of 'appl'. A value of 0 matches any manufacturer.

**componentFlags**

A 32-bit field that contains flags describing required component capabilities. The high-order 8 bits should be set to 0. The low-order 24 bits are specific to each component type. These flags can be used to indicate the presence of features or capabilities in a given component.

**componentFlagsMask**

A 32-bit field that indicates which flags in the `componentFlags` field are relevant to this operation. For each flag in the `componentFlags` field that is to be considered as a search criterion, set the corresponding bit in this field to 1. To ignore a flag, set the bit to 0.

## Constants

---

**canMovieImportInPlace**

Set this bit if a movie import component must be able to create a movie from a file without having to write to a separate disk file. Examples include MPEG and AIFF import components.

**movieImportSubTypeIsFileExtension**

Set this bit if the component's subtype is a file extension instead of a Macintosh file type. For example, if you require an import component that opens files with an extension of `.doc`, set this flag and set your component subtype to `'DOC'`.

**canMovieImportFiles**

Set this bit if a movie import component must import files.



## Quality Atom

---

A quality atom describes the relative quality of a movie. This acts as a tiebreaker if more than one movie meets the specified requirements, and it is not otherwise obvious which movie should be played.

This would be the case if two qualified movies have the same data rate and CPU speed requirements, for example, or if one movie requires a higher data rate and another requires a higher CPU speed, but both can be played on the current system. In these cases, applications should play the movie with the highest quality, as specified in the quality atom.

Only one quality atom is allowed in a given reference movie descriptor atom.

A quality atom may contain the following fields:

**Size**

The number of bytes in this quality atom.

**Type**

The type of this atom; this field must be set to 'rmqu'.

**Quality**

The relative quality of the movie, expressed as a 32-bit integer. A larger number indicates higher quality. A unique value should be given to each movie.



# Media Data Atom Types

---

QuickTime uses atoms of different types to store different types of media data—video media atoms for video data, sound media atoms for audio data, and so on. This chapter discusses in detail each of these different media data atom types.

If you are a QuickTime application or tool developer, you'll want to read this chapter in order to understand the fundamentals of how QuickTime uses atoms for storage of different media data. For the latest updates and postings, be sure to see [Apple's QuickTime developer website](#).

This chapter is divided into the following major sections:

- [“Video Media”](#) (page 100) describes video media, which is used to store compressed and uncompressed image data in QuickTime movies.
- [“Sound Media”](#) (page 117) discusses sound media used to store compressed and uncompressed audio data in QuickTime movies.
- [“Timecode Media”](#) (page 126) describes time code media used to store time code data in QuickTime movies.
- [“Text Media”](#) (page 129) discusses text media used to store text data in QuickTime movies.
- [“Music Media”](#) (page 133) discusses music media used to store note-based audio data, such as MIDI data, in QuickTime movies.
- [“MPEG-1 Media”](#) (page 134) discusses MPEG-1 media used to store MPEG-1 video and MPEG-1 multiplexed audio/video streams in QuickTime movies.
- [“Sprite Media”](#) (page 134) discusses sprite media used to store character-based animation data in QuickTime movies.
- [“Tween Media”](#) (page 153) discusses tween media used to store pairs of values to be interpolated between in QuickTime movies.
- [“Modifier Tracks”](#) (page 163) discusses the capabilities of modifier tracks.
- [“Track References”](#) (page 164) describes a feature of QuickTime that allows you to relate a movie's tracks to one another.
- [“3D Media”](#) (page 165) discusses briefly how QuickTime movies store 3D image data in a base media.
- [“Hint Media”](#) (page 166) describes the additions to the QuickTime file format for streaming QuickTime movies over the Internet.
- [“VR Media”](#) (page 180) describes the QuickTime VR world and node information atom containers, as well as cubic panoramas, which are new to QuickTime VR 3.0.

- [“Movie Media”](#) (page 213) discusses movie media which is used to encapsulate embedded movies within QuickTime movies.

## Video Media

---

Video media is used to store compressed and uncompressed image data in QuickTime movies. It has a media type of 'vide'.

### Video Sample Description

---

The video sample description contains information that defines how to interpret video media data. A video sample description begins with the four fields described in [“General Structure of a Sample Description”](#) (page 79).

The data format field of a video sample description indicates the type of compression that was used to compress the image data, or the color space representation of uncompressed video data. [Table 3-1](#) (page 100) shows some of the formats supported. The list is not exhaustive, and is subject to addition.

**Table 3-1** Some image compression formats

Compression type	Description
'cvid'	Cinepak
'jpeg'	JPEG
'smc '	Graphics
'rle '	Animation
'rpza'	Apple video
'kpcd'	Kodak Photo CD
'png '	Portable Network Graphics
'mjpa'	Motion-JPEG (format A)
'mjpb'	Motion-JPEG (format B)
'SVQ1'	Sorenson video, version 1
'SVQ3'	Sorenson video 3
'mp4v'	MPEG-4 video
'dvc '	NTSC DV-25 video
'dvcp'	PAL DV-25 video

Compression type	Description
'gif '	Compuserve Graphics Interchange Format
'h263'	H.263 video
'tiff'	Tagged Image File Format
'raw '	Uncompressed RGB
'2vuY'	Uncompressed YCbCr, 8-bit-per-component 4:2:2
'yuv2'	Uncompressed YCbCr, 8-bit-per-component 4:2:2
'v308'	Uncompressed YCbCr, 8-bit-per-component 4:4:4
'v408'	Uncompressed YCbCr, 8-bit-per-component 4:4:4:4
'v216'	Uncompressed YCbCr, 10, 12, 14, or 16-bit-per-component 4:2:2
'v410'	Uncompressed YCbCr, 10-bit-per-component 4:4:4
'v210'	Uncompressed YCbCr, 10-bit-per-component 4:2:2

The video media sample description adds the following fields to the general sample description.

#### Version

A 16-bit integer indicating the version number of the compressed data. This is set to 0, unless a compressor has changed its data format.

#### Revision level

A 16-bit integer that must be set to 0.

#### Vendor

A 32-bit integer that specifies the developer of the compressor that generated the compressed data. Often this field contains 'appl' to indicate Apple Computer, Inc.

#### Temporal quality

A 32-bit integer containing a value from 0 to 1023 indicating the degree of temporal compression.

#### Spatial quality

A 32-bit integer containing a value from 0 to 1024 indicating the degree of spatial compression.

#### Width

A 16-bit integer that specifies the width of the source image in pixels.

#### Height

A 16-bit integer that specifies the height of the source image in pixels.

#### Horizontal resolution

A 32-bit fixed-point number containing the horizontal resolution of the image in pixels per inch.

#### Vertical resolution

A 32-bit fixed-point number containing the vertical resolution of the image in pixels per inch.

**Data size**

A 32-bit integer that must be set to 0.

**Frame count**

A 16-bit integer that indicates how many frames of compressed data are stored in each sample. Usually set to 1.

**Compressor name**

A 32-byte Pascal string containing the name of the compressor that created the image, such as "jpeg".

**Depth**

A 16-bit integer that indicates the pixel depth of the compressed image. Values of 1, 2, 4, 8, 16, 24, and 32 indicate the depth of color images. The value 32 should be used only if the image contains an alpha channel. Values of 34, 36, and 40 indicate 2-, 4-, and 8-bit grayscale, respectively, for grayscale images.

**Color table ID**

A 16-bit integer that identifies which color table to use. If this field is set to -1, the default color table should be used for the specified depth. For all depths below 16 bits per pixel, this indicates a standard Macintosh color table for the specified depth. Depths of 16, 24, and 32 have no color table.

If the color table ID is set to 0, a color table is contained within the sample description itself. The color table immediately follows the color table ID field in the sample description. See [“Color Table Atoms”](#) (page 41) for a complete description of a color table.

## Video Sample Description Extensions

---

Video sample descriptions can be extended by appending other atoms. These atoms are placed after the color table, if one is present. These extensions to the sample description may contain display hints for the decompressor or may simply carry additional information associated with the images. [Table 3-2](#) (page 102) lists the currently defined extensions to video sample descriptions.

**Table 3-2** Video sample description extensions

Extension type	Description
'gama'	A 32-bit fixed-point number indicating the gamma level at which the image was captured. The decompressor can use this value to gamma-correct at display time.

Extension type	Description
'fiel'	Two 8-bit integers that define field handling. This information is used by applications to modify decompressed image data or by decompressor components to determine field display order. This extension is mandatory for all uncompressed YCbCr data formats. The first byte specifies the field count, and may be set to 1 or 2. A value of 1 is used for progressive-scan images; a value of 2 indicates interlaced images. When the field count is 2, the second byte specifies the field ordering: which field contains the topmost scan-line, which field should be displayed earliest, and which is stored first in each sample. Each sample consists of two distinct compressed images, each coding one field: the field with the topmost scan-line, T, and the other field, B. The following defines the permitted variants: 0 – There is only one field. 1 – T is displayed earliest, T is stored first in the file. 6 – B is displayed earliest, B is stored first in the file. 9 – B is displayed earliest, T is stored first in the file. 14 – T is displayed earliest, B is stored first in the file.
'mjqt'	The default quantization table for a Motion-JPEG data stream.
'mjht'	The default Huffman table for a Motion-JPEG data stream.
'esds'	An MPEG-4 elementary stream descriptor atom. This extension is required for MPEG-4 video. For details, see “ <a href="#">MPEG-4 Elementary Stream Descriptor ('esds') Atom</a> ” (page 104).
'pasp'	Pixel aspect ratio. This extension is mandatory for video formats that use non-square pixels. For details, see “ <a href="#">Pixel Aspect Ratio ('pasp')</a> ” (page 103).
'colr'	Color parameters—an image description extension required for all uncompressed YCbCr video types. For details, see “ <a href="#">Color Parameter Atoms ('colr')</a> ” (page 105).
'clap'	Clean aperture—spatial relationship of YCbCr components relative to a canonical image center. This allows accurate alignment for compositing of video images captured using different systems. This is a mandatory extension for all uncompressed YCbCr data formats. For details, see “ <a href="#">Clean Aperture ('clap')</a> ” (page 110).

### Pixel Aspect Ratio ('pasp')

This extension specifies the height-to-width ratio of pixels found in the video sample. This is a required extension for MPEG-4 and uncompressed YCbCr video formats when non-square pixels are used. It is optional when square pixels are used.

#### Size

An unsigned 32-bit integer holding the size of the pixel aspect ratio atom.

#### Type

An unsigned 32-bit field containing the four-character code 'pasp'.

#### hSpacing

An unsigned 32-bit integer specifying the horizontal spacing of pixels, such as luma sampling instants for YCbCr or YUV video.

#### vSpacing

An unsigned 32-bit integer specifying the vertical spacing of pixels, such as video picture lines.

The units of measure for the `hSpacing` and `vSpacing` parameters are not specified, as only the ratio matters. The units of measure for height and width must be the same, however.

**Table 3-3** Common pixel aspect ratios

Description	hSpacing	vSpacing
4:3 square pixels (composite NTSC or PAL)	1	1
4:3 non-square 525 (NTSC)	10	11
4:3 non-square 625 (PAL)	59	54
16:9 analog (composite NTSC or PAL)	4	3
16:9 digital 525 (NTSC)	40	33
16:9 digital 625 (PAL)	118	81
1920x1035 HDTV (per SMPTE 260M-1992)	113	118
1920x1035 HDTV (per SMPTE RP 187-1995)	1018	1062
1920x1080 HDTV or 1280x720 HDTV	1	1

### MPEG-4 Elementary Stream Descriptor Atom ('esds')

This atom contains an MPEG-4 elementary stream descriptor atom. This is a required extension to the video sample description for MPEG-4 video. This extension appears in video sample descriptions only when the codec type is 'mp4v'.

**Note:** The elementary stream descriptor which this atom contains is defined in the MPEG-4 specification ISO/IEC FDIS 14496-1.

#### Size

An unsigned 32-bit integer holding the size of the elementary stream descriptor atom.

#### Type

An unsigned 32-bit field containing the four-character code 'esds'

#### Version

An unsigned 8-bit integer set to zero.

#### Flags

A 24-bit field reserved for flags, currently set to zero.

#### Elementary Stream Descriptor

An elementary stream descriptor for MPEG-4 video, as defined in the MPEG-4 specification ISO/IEC 14496-1 and subject to the restrictions for storage in MPEG-4 files specified in ISO/IEC 14496-14.



### Color Parameter Atoms ('colr')

---

This atom is a required extension for uncompressed YCbCr data formats. The 'colr' extension is used to map the numerical values of pixels in the file to a common representation of color in which images can be correctly compared, combined, and displayed. The common representation is the CIE XYZ tristimulus values (defined in Publication CIE No. 15.2).

Use of a common representation also allows you to correctly map between YCbCr and RGB color spaces and to correctly compensate for gamma on different systems.

The 'colr' extension supersedes the previously defined 'gamma' Image Description extension. Writers of QuickTime files should never write both into an Image Description, and readers of QuickTime files should ignore 'gamma' if 'colr' is present.

The 'colr' extension is designed to work for multiple imaging applications such as video and print. Each application, driven by its own set of historical and economic realities, has its own set of parameters needed to map from pixel values to CIE XYZ.

The CIE XYZ representation is mapped to various stored YCbCr formats using a common set of transfer functions and matrixes. The transfer function coefficients and matrix values are stored as indexes into a table of canonical references. This provides support for multiple video systems while limiting the scope of possible values to a set of recognized standards.

The 'colr' atom contains four fields: a color parameter type and three indexes. The indexes are to a table of primaries, a table of transfer function coefficients, and a table of matrixes.

**Figure 3-1** Color atom

	Bytes
Color atom	
Atom size	4
Type = 'colr'	4
Color parameter type = 'nclc'	4
Primaries index = 1	2
Transfer function index = 1	2
Matrix index = 1	2

The table of matrixes specifies the matrix used during the translation, as shown in [Figure 3-2](#) (page 106).

Color parameter type

A 32-bit field containing a four-character code for the color parameter type. The currently defined types are 'nclc' for video, and 'prof' for print. The color parameter type distinguishes between print and video mappings.

If the color parameter type is 'prof', then this field is followed by an ICC profile. This is the color model used by Apple's ColorSync. The contents of this type are not defined in this document. Contact Apple Computer for more information on the 'prof' type 'colr' extension.

If the color parameter type is 'nclc' then this atom contains the following fields:

Primaries index

A 16-bit unsigned integer containing an index into a table specifying the CIE 1931 xy chromaticity coordinates of the white point and the red, green, and blue primaries. The table of primaries specifies the white point and the red, green, and blue primary color points for a video system.

Transfer function index

A 16-bit unsigned integer containing an index into a table specifying the nonlinear transfer function coefficients used to translate between RGB color space values and YCbCr values. The table of transfer function coefficients specifies the nonlinear function coefficients used to translate between the stored YCbCr values and a video capture or display system, as shown in Figure 3-2 (page 106).

Matrix index

A 16-bit unsigned integer containing an index into a table specifying the transformation matrix coefficients used to translate between RGB color space values and YCbCr values. The table of matrices specifies the matrix used during the translation, as shown in Figure 3-2 (page 106).

The transfer function and matrix are used as shown in the following diagram.

Figure 3-2 Transfer between RGB and Y CbCr color spaces

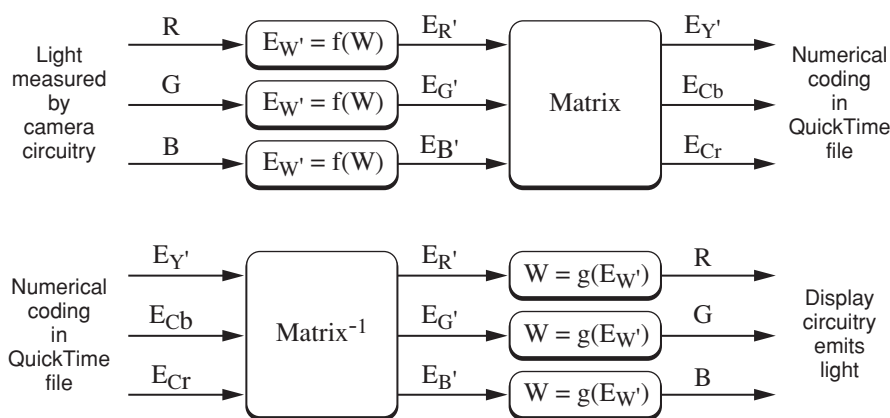

The YCbCr values stored in a file are normalized to a range of [0,1] for Y and [-0.5, +0.5] for Cb and Cr when performing these operations. The normalized values are then scaled to the proper bit depth for a particular YCbCr format before storage in the file.

**Figure 3-3** The normalized values are shown using the symbol  $E$  with a subscript for  $Y$ ,  $Cb$ , or  $Cr$ :

$E_{Y'}$  has the range  $[0, 1]$

$E_{Cb}$  has the range  $[-0.5, +0.5]$

$E_{Cr}$  has the range  $[-0.5, +0.5]$

**Note:** The symbols used for these values are not intended to correspond to the use of these same symbols in other standards. In particular, "E" should not be interpreted as voltage.

These normalized values can be mapped onto the stored integer values of a particular compression type's  $Y$ ,  $Cb$ , and  $Cr$  components using two different schemes, which we will call Scheme A and Scheme B.

 **Warning:** Other, slightly different encoding/mapping schemes exist in the video industry, and data encoded using these schemes must be converted to one of the QuickTime schemes defined here.

Scheme A uses "Wide-Range" mapping (full scale) with unsigned  $Y$  and twos-complement  $Cb$  and  $Cr$  values.

**Figure 3-4** Equations for stored  $Y$   $Cb$   $Cr$  values of bit-depth of  $n$  in scheme A

$$Y' = \text{floor} (0.5 + (2^{n-1}) * E_{Y'})$$

$$Cb = \text{floor} (0.5 + (2^{n-2}) * E_{Cb})$$

$$Cr = \text{floor} (0.5 + (2^{n-2}) * E_{Cr})$$

This maps normalized values to stored values so that, for example, 8-bit unsigned values for  $Y$  go from 0-255 as the normalized value goes from 0 to 1, and 8-bit signed values for  $Cb$  and  $Cr$  go from -127 to +127 as the normalized values go from -0.5 to +0.5.

 **Warning:** In specifications such as ITU-R BT.601-4, JFIF 1.02, and SPIFF (Rec. ITU-T T.84), the symbols  $Cb$  and  $Cr$  are used to describe offset binary integers, not twos-complement signed integers shown here.

Scheme B uses "Video-Range" mapping with unsigned  $Y$  and offset binary  $Cb$  and  $Cr$  values.

**Note:** Scheme B comes from digital video industry specifications such as Rec. ITU-R BT. 601-4. All standard digital video tape formats (e.g., SMPTE D-1, SMPTE D-5) and all standard digital video links (e.g., SMPTE 259M-1997 serial digital video) use this scheme. Professional video storage and processing equipment from vendors such as Abekas, Accom, and SGI also use this scheme. MPEG-2, DVC and many other codecs specify source YCbCr pixels using this scheme.

**Figure 3-5** Equations for stored Y CbCr values of bit-depth  $n$  in scheme B

$$Y' = \text{floor} (0.5 + 2^{n-8} * (219 * E_{Y'} + 16))$$

$$Cb = \text{floor} (0.5 + 2^{n-8} * (224 * E_{Cb} + 128))$$

$$Cr = \text{floor} (0.5 + 2^{n-8} * (224 * E_{Cr} + 128))$$

This maps the normalized values to stored values so that, for example, 8-bit unsigned values for Y go from 16–235 as the normalized value goes from 0 to 1, and 8-bit unsigned values for Cb and Cr go from 16–240 as the normalized values go from -0.5 to +0.5.

For 10-bit samples, Y has a range of 64 to 940 as the normalized value goes from 0 to 1, and Cb and Cr have the range of 65–960 as the normalized values go from -0.5 to +0.5.

Y is an unsigned integer. Cb and Cr are offset binary integers.

Certain Y, Cb, and Cr component values are reserved as synchronization signals and must not appear in a buffer. For  $n = 8$  bits, these are values 0 and 255. For  $n = 10$  bits, these are values 0, 1, 2, 3, 1020, 1021, 1022, and 1023. The writer of a QuickTime image is responsible for omitting these values. The reader of a QuickTime image may assume that they are not present.

The remaining component values that fall outside the mapping for scheme B (1–15 and 241–254 for  $n = 8$  bits and 4–63 and 961–1019 for  $n = 10$  bits) accommodate occasional filter undershoot and overshoot in image processing. In some applications, these values are used to carry other information (e.g., transparency). The writer of a QuickTime image may use these values and the reader of a QuickTime image must expect these values.

The following tables show the primary values, transfer functions, and matrixes indicated by the index entries in the 'colr' atom.

The R, G, and B values below are tristimulus values (such as candelas/meter<sup>2</sup>), whose relationship to CIE XYZ values can be derived from the primaries and white point specified in the table, using the method described in SMPTE RP 177-1993. In this instance, the R, G, and B values are normalized to the range [0,1].

**Table 3-4** Table of primaries, index and values

Index	Values
0	Reserved
1	Recommendation ITU-R BT.709-2, SMPTE 274M-1995, and SMPTE 296M-1997 white $x = 0.3127$ $y = 0.3290$ (CIE III. D65) red $x = 0.640$ $y = 0.330$ green $x = 0.300$ $y = 0.600$ blue $x = 0.150$ $y = 0.060$
2	Primary values are unknown

Index	Values
3-4	Reserved
5	SMPTE RP 145-1993, SMPTE170M-1994, 293M-1996, 240M-1995, and SMPTE 274M-1995 white $x = 0.3127$ $y = 0.3290$ (CIE III. D65) red $x = 0.64$ $y = 0.33$ green $x = 0.29$ $y = 0.60$ blue $x = 0.15$ $y = 0.06$
6	ITU-R BT.709-2, SMPTE 274M-1995, and SMPTE 296M-1997 white $x = 0.3127$ $y = 0.3290$ (CIE III. D65) red $x = 0.630$ $y = 0.340$ green $x = 0.310$ $y = 0.595$ blue $x = 0.155$ $y = 0.070$
7-65535	Reserved

The transfer functions below are used as shown in [Figure 3-2](#) (page 106).

**Table 3-5** Table of transfer function index and values

Index	Video Standards
0	Reserved
1	Recommendation ITU-R BT.709-2, SMPTE 274M-1995, 296M-1997, 293M-1996, 170M-1994 See below for transfer function equations.
2	Coefficient values are unknown
3-6	Reserved
7	Recommendation SMPTE 240M-1995 and 274M-1995 See below for transfer function equations.
8-65535	Reserved

The MPEG-2 sequence display extension `transfer_characteristics` defines a code 6 whose transfer function is identical to that in code 1. QuickTime writers should map 6 to 1 when converting from `transfer_characteristics` to `transferFunction`.

Recommendation ITU-R BT.470-4 specified an "assumed gamma value of the receiver for which the primary signals are pre-corrected" as 2.2 for NTSC and 2.8 for PAL systems. This information is both incomplete and obsolete. Modern 525- and 625-line digital and NTSC/PAL systems use the transfer function with code 1 below.

**Figure 3-6** Equations for index code 1

$$E_W' = 4.500 W \text{ for } 0 \leq W < 0.018$$

$$E_W' = 1.099 W^{0.45} - 0.099 \text{ for } 0.018 \leq W \leq 1$$

**Figure 3-7** Equations for index code 7

$$E_W' = 4 W \text{ for } 0 \leq W < 0.0228$$

$$E_W' = 1.1115 W^{0.45} - 0.115 \text{ for } 0.0228 \leq W \leq 1$$

The matrix values are shown in [Table 3-6](#) (page 110) and in [Figure 3-8](#) (page 110), [Figure 3-9](#) (page 110), and [Figure 3-10](#) (page 110). These figures show a formula for obtaining the normalized value of Y in the range [0,1]. You can derive the formula for normalized values of Cb and Cr as follows:

If the equation for normalized Y has the form:

$$E_Y' = K_G' E_G' + K_B' E_B' + K_R' E_R'$$

Then the formulas for normalized Cb and Cr are:

$$E_{Cb} = (0.5/(1 - K_B')) (E_B' - E_Y')$$

$$E_{Cr} = (0.5/(1 - K_R')) (E_R' - E_Y')$$

**Table 3-6** Table of matrix index and values

Index	Video Standard
0	Reserved
1	Recommendation ITU-R BT.709-2 (1125/60/2:1 only), SMPTE 274M-1995, 296M-1997 See below for matrix values.
2	Coefficient values are unknown
3–5	Reserved
6	Recommendation ITU-R BT.601-4 and BT.470-4 System B and G, SMPTE 170M-1994, 293M-1996 See below for matrix values
7	SMPTE 240M-1995, 274M-1995 See below for matrix values
8–65535	Reserved

**Figure 3-8** Matrix values for index code 1

$$E_Y' = 0.7152 E_G' + 0.0722 E_B' + 0.2126 E_R'$$

**Figure 3-9** Matrix values for index code 6

$$E_Y' = 0.587 E_G' + 0.114 E_B' + 0.299 E_R'$$

**Figure 3-10** Matrix values for index code 7

$$E_Y' = 0.701 E_G' + 0.087 E_B' + 0.212 E_R'$$

### Clean Aperture ('clap')

The clean aperture extension defines the relationship between the pixels in a stored image and a canonical rectangular region of a video system from which it was captured or to which it will be displayed. This can be used to correlate pixel locations in two or more images—possibly recorded using different systems—for accurate compositing. This is necessary because different video digitizer

devices can digitize different regions of the incoming video signal, causing pixel misalignment between images. In particular, a stored image may contain “edge” data outside the canonical display area for a given system.

The clean aperture is either coincident with the stored image or a subset of the stored image; if it is a subset, it may be centered on the stored image, or it may be offset positively or negatively from the stored image center.

The clean aperture extension contains a width in pixels, a height in picture lines, and a horizontal and vertical offset between the stored image center and a canonical image center for the given video system. The width is typically the width of the canonical clean aperture for a video system divided by the pixel aspect ratio of the stored data. The offsets also take into account any “overscan” in the stored image. The height and width must be positive values, but the offsets may be positive, negative, or zero.

These values are given as ratios of two 32-bit numbers, so that applications can calculate precise values with minimum roundoff error. For whole values, the value should be stored in the numerator field while the denominator field is set to 1.

#### Size

A 32-bit unsigned integer containing the size of the 'clap' atom.

#### Type

A 32-bit unsigned integer containing the four-character code 'clap'.

#### apertureWidth\_N (numerator)

A 32-bit signed integer containing either the width of the clean aperture in pixels or the numerator portion of a fractional width.

#### apertureWidth\_D (denominator)

A 32-bit signed integer containing either the denominator portion of a fractional width or the number 1.

#### apertureHeight\_N (numerator)

A 32-bit signed integer containing either the height of the clean aperture in picture lines or the numerator portion of a fractional height.

#### apertureHeight\_D (denominator)

A 32-bit signed integer containing either the denominator portion of a fractional height or the number 1.

#### horizOff\_N (numerator)

A 32-bit signed integer containing either the horizontal offset of the clean aperture center minus  $(width-1)/2$  or the numerator portion of a fractional offset. This value is typically zero.

#### horizOff\_D (denominator)

A 32-bit signed integer containing either the denominator portion of the horizontal offset or the number 1.

#### vertOff\_N (numerator)

A 32-bit signed integer containing either the vertical offset of the clean aperture center minus  $(height-1)/2$  or the numerator portion of a fractional offset. This value is typically zero.

#### vertOff\_D (denominator)

A 32-bit signed integer containing either the denominator portion of the vertical offset or the number 1.

## Video Sample Data

---

The format of the data stored in video samples is completely dependent on the type of the compression used, as indicated in the video sample description. The following sections discuss some of the video encoding schemes supported by QuickTime.

### Uncompressed RGB

---

Uncompressed RGB data is stored in a variety of different formats. The format used depends on the depth field of the video sample description. For all depths, the image data is padded on each scan line to ensure that each scan line begins on an even byte boundary.

- For depths of 1, 2, 4, and 8, the values stored are indexes into the color table specified in the color table ID field.
- For a depth of 16, the pixels are stored as 5-5-5 RGB values with the high bit of each 16-bit integer set to 0.
- For a depth of 24, the pixels are stored packed together in RGB order.
- For a depth of 32, the pixels are stored with an 8-bit alpha channel, followed by 8-bit RGB components.

RGB data can be stored in composite or planar format. Composite format stores the RGB data for each pixel contiguously, while planar format stores the R, G, and B data separately, so the RGB information for a given pixel is found using the same offset into multiple tables. For example, the data for two pixels could be represented in composite format as RGB-RGB or in planar format as RR-GG-BB.

### Uncompressed YCbCr (including yuv2)

---

The YCbCr color space is widely used for digital video. In this data format, luminance is stored as a single value (Y), and chrominance information is stored as two color-difference components (Cb and Cr). Cb is the difference between the blue component and a reference value; Cr is the difference between the red component and a reference value.

This is commonly referred to as “YUV” format, with “U” standing-in for Cb and “V” standing-in for Cr. This usage is not strictly correct, as YUV, YIC, and YCbCr are distinct color models for PAL, NTSC, and digital video, but most YCbCr data formats and codecs are described or even named as some variant of “YUV.”

The values of Y, Cb, and Cr can be represented using a variety of bit depths, trading off accuracy for file size. Similarly, the chrominance values can be sub-sampled, recording only one pixel’s color value out of two, for example, or averaging the color value of adjacent pixels. This sub-sampling is a form of compression, but if no additional lossy compression is performed on the sampled video, it is still referred to as “uncompressed” YCbCr video. In addition, a fourth component can be added to YCbCr video to record an alpha channel.

The number of components (YCbCr with or without alpha) and any sub-sampling are denoted using ratios of three or four numbers, such as 4:2:2 to indicate 4 bits of Y to 2 bits each of Cb and Cr (chroma sub-sampling), or 4:4:4 for equal storage of Y, Cb, and Cr (no sub-sampling), or 4:4:4:4 for YCbCr plus alpha with no sub-sampling. The ratios do not typically denote actual bit depths.



Uncompressed YCbCr video data is typically stored as follows:

- Y, Cb, and Cr components of each line are stored spatially left to right and temporally from earliest to latest.
- The lines of a field or frame are stored spatially top to bottom and temporally earliest to latest.
- Y is an unsigned integer. Cb and Cr are two's-complement signed integers.

The yuv2 stream, for example, is encoded in a series of 4-byte packets. Each packet represents two adjacent pixels on the same scan line. The bytes within each packet are ordered as follows:

```
y0 u y1 v
```

y0 is the luminance value for the left pixel; y1 the luminance for the right pixel. u and v are chromatic values that are shared by both pixels.

Accurate conversion between RGB and YCbCr color spaces requires a computation for each component of each pixel. An example conversion from yuv2 into RGB is represented by the following equations:

$$r = 1.402 * v + y + .5$$

$$g = y - .7143 * v - .3437 * u + .5$$

$$b = 1.77 * u + y + .5$$

The r, g, and b values range from 0 to 255.

The coefficients in these equations are derived from matrix operations and depend on the reference values used for the primary colors and for white. QuickTime uses canonical values for these reference coefficients based on published standards. The sample description extension for YCbCr formats includes a 'colr' atom, which contains indexes into a table of canonical references. This provides support for multiple video standards without opening the door to data entry errors for stored coefficient values. Refer to the published standards for the formulas and methods used to derive conversion coefficients from the table entries.

## JPEG

---

QuickTime stores JPEG images according to the rules described in the ISO JPEG specification, document number DIS 10918-1.

## MPEG-4 Video

---

MPEG-4 video uses the 'mp4v' data format. The sample description requires the elementary stream descriptor ('esds') extension to the standard video sample description. If non-square pixels are used, the pixel aspect ratio ('pasp') extension is also required. For details on these extensions, see [“Pixel Aspect Ratio \(pasp\)”](#) (page 103) and [“MPEG-4 Elementary Stream Descriptor Atom \(esds\)”](#) (page 104).

MPEG-4 video conforms to ISO/IEC documents 14496-1/2000(E) and 14496-2:1999/Amd.1:2000(E).

## Motion-JPEG

Motion-JPEG (M-JPEG) is a variant of the ISO JPEG specification for use with digital video streams. Instead of compressing an entire image into a single bitstream, Motion-JPEG compresses each video field separately, returning the resulting JPEG bitstreams consecutively in a single frame.

There are two flavors of Motion-JPEG currently in use. These two formats differ based on their use of markers. Motion-JPEG format A supports markers; Motion-JPEG format B does not. The following paragraphs describe how QuickTime stores Motion-JPEG sample data. [Figure 3-11](#) (page 114) shows an example of Motion-JPEG A dual-field sample data. [Figure 3-12](#) (page 116) shows an example of Motion-JPEG B dual-field sample data.

**Figure 3-11** Motion-JPEG A dual-field sample data

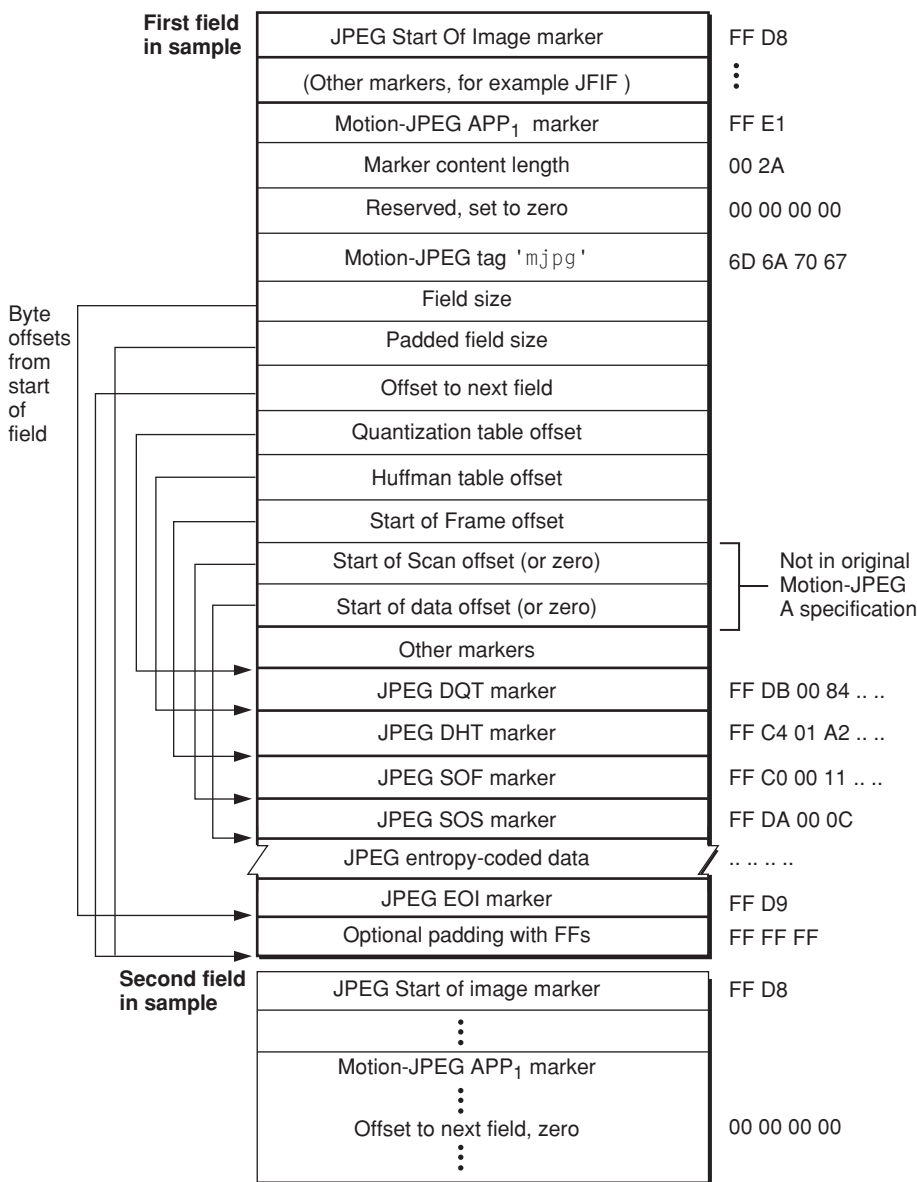

Each field of Motion-JPEG format A fully complies with the ISO JPEG specification, and therefore supports application markers. QuickTime uses the APP1 marker to store control information, as follows (all of the fields are 32-bit integers):

**Reserved**

Unpredictable; should be set to 0.

**Tag**

Identifies the data type; this field must be set to 'mjpg'.

**Field size**

The actual size of the image data for this field, in bytes.

**Padded field size**

Contains the size of the image data, including pad bytes. Some video hardware may append pad bytes to the image data; this field, along with the field size field, allows you to compute how many pad bytes were added.

**Offset to next field**

The offset, in bytes, from the start of the field data to the start of the next field in the bitstream. This field should be set to 0 in the last field's marker data.

**Quantization table offset**

The offset, in bytes, from the start of the field data to the quantization table marker. If this field is set to 0, check the image description for a default quantization table.

**Huffman table offset**

The offset, in bytes, from the start of the field data to the Huffman table marker. If this field is set to 0, check the image description for a default Huffman table.

**Start of frame offset**

The offset from the start of the field data to the start of image marker. This field should never be set to 0.

**Start of scan offset**

The offset, in bytes, from the start of the field data to the start of the scan marker. This field should never be set to 0.

**Start of data offset**

The offset, in bytes, from the start of the field data to the start of the data stream. Typically, this immediately follows the start of scan data.

**Note:** The last two fields have been added since the original Motion-JPEG specification, and so they may be missing from some Motion-JPEG A files. You should check the length of the APP1 marker before using the start of scan offset and start of data offset fields.

Motion-JPEG format B does not support markers. In place of the marker, therefore, QuickTime inserts a header at the beginning of the bitstream. Again, all of the fields are 32-bit integers.

**Figure 3-12** Motion-JPEG B dual-field sample data

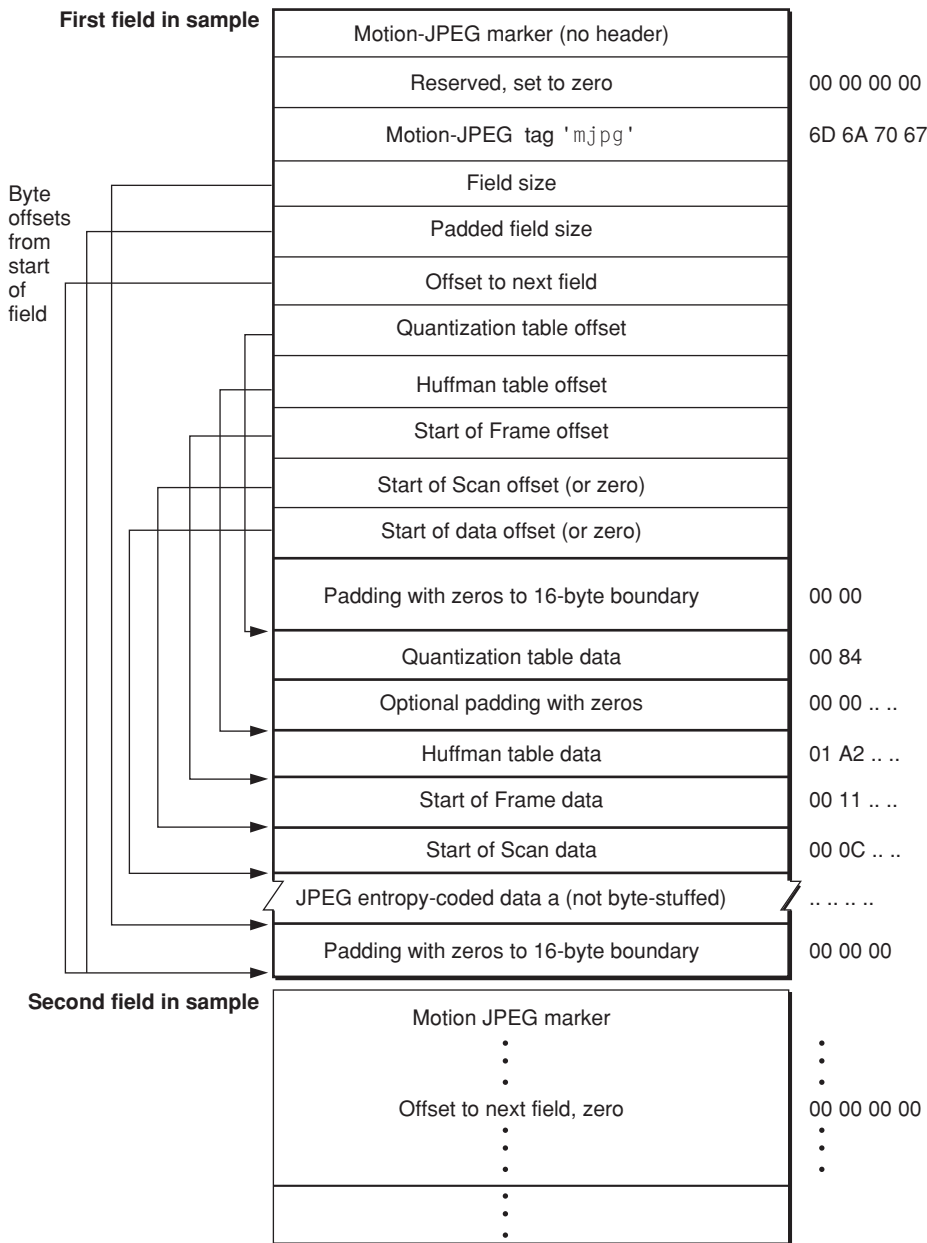

**Reserved**  
Unpredictable; should be set to 0.

**Tag**  
The data type; this field must be set to 'mjppg'.

**Field size**  
The actual size of the image data for this field, in bytes.

**Padded field size**

The size of the image data, including pad bytes. Some video hardware may append pad bytes to the image data; this field, along with the field size field, allows you to compute how many pad bytes were added.

**Offset to next field**

The offset, in bytes, from the start of the field data to the start of the next field in the bitstream. This field should be set to 0 in the second field's header data.

**Quantization table offset**

The offset, in bytes, from the start of the field data to the quantization table. If this field is set to 0, check the image description for a default quantization table.

**Huffman table offset**

The offset, in bytes, from the start of the field data to the Huffman table. If this field is set to 0, check the image description for a default Huffman table.

**Start of frame offset**

The offset from the start of the field data to the field's image data. This field should never be set to 0.

**Start of scan offset**

The offset, in bytes, from the start of the field data to the start of scan data.

**Start of data offset**

The offset, in bytes, from the start of the field data to the start of the data stream. Typically, this immediately follows the start of scan data.

**Note:** The last two fields were “reserved, must be set to zero” in the original Motion-JPEG specification.

The Motion-JPEG format B header must be a multiple of 16 in size. When you add pad bytes to the header, set them to 0.

Because Motion-JPEG format B does not support markers, the JPEG bitstream does not have null bytes (0x00) inserted after data bytes that are set to 0xFF.

## Sound Media

---

Sound media is used to store compressed and uncompressed audio data in QuickTime movies. It has a media type of 'soun'. This section describes the sound sample description and the storage format of sound files using various data formats.

### Sound Sample Descriptions

---

The sound sample description contains information that defines how to interpret sound media data. This sample description is based on the standard sample description, as described in [“Sample Description Atoms”](#) (page 78).

The data format field contains the format of the audio data. This may specify a compression format or one of several uncompressed audio formats. [Table 3-7](#) (page 118) shows a list of some supported sound formats.

**Table 3-7** Partial list of supported QuickTime audio formats.

Format	4-Character code	Description
Not specified	0x00000000	This format descriptor should not be used, but may be found in some files. Samples are assumed to be stored in either 'raw ' or 'twos' format, depending on the sample size field in the sound description.
kSoundNotCompressed	'NONE'	This format descriptor should not be used, but may be found in some files. Samples are assumed to be stored in either 'raw ' or 'twos' format, depending on the sample size field in the sound description.
k8BitOffsetBinaryFormat	'raw '	Samples are stored uncompressed, in offset-binary format (values range from 0 to 255; 128 is silence). These are stored as 8-bit offset binaries.
k16BitBigEndianFormat	'twos'	Samples are stored uncompressed, in two's-complement format (sample values range from -128 to 127 for 8-bit audio, and -32768 to 32767 for 1-bit audio; 0 is always silence). These samples are stored in 16-bit big-endian format.
k16BitLittleEndianFormat	'sowt'	16-bit little-endian, twos-complement
kMACE3Compression	'MAC3'	Samples have been compressed using MACE 3:1. (Obsolete.)
kMACE6Compression	'MAC6'	Samples have been compressed using MACE 6:1. (Obsolete.)
kIMACCompression	'ima4'	Samples have been compressed using IMA 4:1.
kFloat32Format	'f132'	32-bit floating point
kFloat64Format	'f164'	64-bit floating point
k24BitFormat	'in24'	24-bit integer
k32BitFormat	'in32'	32-bit integer
kULawCompression	'ulaw'	uLaw 2:1
kALawCompression	'alaw'	uLaw 2:1
kMicrosoftADPCMFormat	0x6D730002	Microsoft ADPCM-ACM code 2

Format	4-Character code	Description
kDVIIntelIMAFormat	0x6D730011	DVI/Intel IMAADPCM-ACM code 17
kDVAudioFormat	'dvca'	DV Audio
kQDesignCompression	'QDMC'	QDesign music
kQDesign2Compression	'QDM2'	QDesign music version 2
kQUALCOMMCompression	'Qc1p'	QUALCOMM PureVoice
kMPEGLayer3Format	0x6D730055	MPEG-1 layer 3, CBR only (pre-QT4.1)
kFullMPEGLay3Format	'.mp3'	MPEG-1 layer 3, CBR & VBR (QT4.1 and later)
kMPEG4AudioFormat	'mp4a'	MPEG-4 audio

### Sound Sample Description (Version 0)

---

There are currently two versions of the sound sample description, version 0 and version 1. Version 0 supports only uncompressed audio in raw ('raw') or twos-complement ('twos') format, although these are sometimes incorrectly specified as either 'NONE' or 0x00000000.

#### Version

A 16-bit integer that holds the sample description version (currently 0 or 1).

#### Revision level

A 16-bit integer that must be set to 0.

#### Vendor

A 32-bit integer that must be set to 0.

#### Number of channels

A 16-bit integer that indicates the number of sound channels used by the sound sample. Set to 1 for monaural sounds, 2 for stereo sounds. Higher numbers of channels are not supported.

#### Sample size (bits)

A 16-bit integer that specifies the number of bits in each uncompressed sound sample. Allowable values are 8 or 16. Formats using more than 16 bits per sample set this field to 16 and use sound description version 1.

#### Compression ID

A 16-bit integer that must be set to 0 for version 0 sound descriptions. This may be set to -2 for some version 1 sound descriptions; see [“Redefined Sample Tables”](#) (page 121).

#### Packet size

A 16-bit integer that must be set to 0.

#### Sample rate

A 32-bit unsigned fixed-point number (16.16) that indicates the rate at which the sound samples were obtained. The integer portion of this number should match the media's time scale. Many older version 0 files have values of 22254.5454 or 11127.2727, but most files have integer values, such as 44100. Sample rates greater than  $2^{16}$  are not supported.

Version 0 of the sound description format assumes uncompressed audio in 'raw' or 'twos' format, 1 or 2 channels, 8 or 16 bits per sample, and a compression ID of 0.

### Sound Sample Description (Version 1)

---

The version field in the sample description is set to 1 for this version of the sound description structure. In version 1 of the sound description, introduced in QuickTime 3, the sound description record is extended by 4 fields, each 4 bytes long, and includes the ability to add atoms to the sound description.

These added fields are used to support out-of-band configuration settings for decompression and to allow some parsing of compressed QuickTime sound tracks without requiring the services of a decompressor.

These fields introduce the idea of a **packet**. For uncompressed audio, a packet is a sample from a single channel. For compressed audio, this field has no real meaning; by convention, it is treated as 1/number-of-channels.

These fields also introduce the idea of a **frame**. For uncompressed audio, a frame is one sample from each channel. For compressed audio, a frame is a compressed group of samples whose format is dependent on the compressor.

**Important:** The value of all these fields has different meaning for compressed and uncompressed audio. The meaning may not be easily deducible from the field name.

The four new fields are:

- Samples per packet—the number of uncompressed frames generated by a compressed frame (an uncompressed frame is one sample from each channel). This is also the frame duration, expressed in the media's timescale, where the timescale is equal to the sample rate. For uncompressed formats, this field is always 1.
- Bytes per packet—for uncompressed audio, the number of bytes in a sample for a single channel. This replaces the older *sampleSize* field, which is set to 16.  
This value is calculated by dividing the frame size by the number of channels. The same calculation is performed to calculate the value of this field for compressed audio, but the result of the calculation is not generally meaningful for compressed audio.
- Bytes per frame—the number of bytes in a frame: for uncompressed audio, an uncompressed frame; for compressed audio, a compressed frame. This can be calculated by multiplying the bytes per packet field by the number of channels.
- Bytes per sample—the size of an uncompressed sample in bytes. This is set to 1 for 8-bit audio, 2 for all other cases, even if the sample size is greater than 2 bytes.

When capturing or compressing audio using the QuickTime API, the value of these fields can be obtained by calling the Apple Sound Manager's `GetCompression` function. Historically, the value returned for the bytes per frame field was not always reliable, however, so this field was set by multiplying bytes per packet by the number of channels.



To facilitate playback on devices that support only one or two channels of audio in 'raw' or 'twos' format (such as most early Macintosh and Windows computers), all other uncompressed audio formats are treated as compressed formats, allowing a simple "decompressor" component to perform the necessary format conversion during playback. The audio samples are treated as opaque compressed frames for these data types, and the fields for sample size and bytes per sample are not meaningful.

The new fields correspond to the `CompressionInfo` structure used by the Macintosh Sound Manager (which uses 16-bit values) to describe the compression ratio of fixed ratio audio compression algorithms. If these fields are not used, they are set to 0. File readers only need to check to see if `samplesPerPacket` is 0.

### Redefined Sample Tables

---

If the compression ID in the sample description is set to `-2`, the sound track uses redefined sample tables optimized for compressed audio.

Unlike video media, the data structures for QuickTime sound media were originally designed for uncompressed samples. The extended version 1 sound description structure provides a great deal of support for compressed audio, but it does not deal directly with the sample table atoms that point to the media data.

The ordinary sample tables do not point to compressed frames, which are the fundamental units of compressed audio data. Instead, they appear to point to individual uncompressed audio samples, each one byte in size, within the compressed frames. When used with the QuickTime API, QuickTime compensates for this fiction in a largely transparent manner, but attempting to parse the sound samples using the original sample tables alone can be quite complicated.

With the introduction of support for the playback of variable bit-rate (VBR) audio in QuickTime 4.1, the contents of a number of these fields were redefined, so that a frame of compressed audio is treated as a single media sample. The `sample-to-chunk` and `chunk offset` atoms point to compressed frames, and the `sample size table` documents the size of the frames. The size is constant for CBR audio, but can vary for VBR.

The `time-to-sample` table documents the duration of the frames. If the time scale is set to the sampling rate, which is typical, the duration equals the number of uncompressed samples in each frame, which is usually constant even for VBR (it is common to use a fixed frame duration). If a different media timescale is used, it is necessary to convert from timescale units to sampling rate units to calculate the number of samples.

This change in the meaning of the sample tables allows you to use the tables accurately to find compressed frames.

To indicate that this new meaning is used, a version 1 sound description is used and the `compression ID` field is set to `-2`. The `samplesPerPacket` field and the `bytesPerSample` field are not necessarily meaningful for variable bit rate audio, but these fields should be set correctly in cases where the values are constant; the other two new fields (`bytesPerPacket` and `bytesPerFrame`) are reserved and should be set to 0.

If the `compression ID` field is set to zero, the sample tables describe uncompressed audio samples and cannot be used directly to find and manipulate compressed audio frames. QuickTime has built-in support that allows programmers to act as if these sample tables pointed to uncompressed 1-byte audio samples.

## Sound Sample Description Extensions

---

Version 1 of the sound sample description also defines how extensions are added to the `SoundDescription` record.

```
struct SoundDescriptionV1 {
    // original fields
    SoundDescription desc;
    // fixed compression ratio information
    unsigned long samplesPerPacket;
    unsigned long bytesPerPacket;
    unsigned long bytesPerFrame;
    unsigned long bytesPerSample;
    // optional, additional atom-based fields --
    // ([long size, long type, some data], repeat)
};
```

All extensions to the `SoundDescription` record are made using atoms. That means one or more atoms can be appended to the end of the `SoundDescription` record using the standard [size, type] mechanism used throughout the QuickTime movie architecture.

### siSlopeAndIntercept Atom

---

One possible extension to the `SoundDescription` record is the `siSlopeAndIntercept` atom, which contains `slope`, `intercept`, `minClip`, and `maxClip` parameters.

At runtime, the contents of the type `siSlopeAndIntercept` and `siDecompressorSettings` atoms are provided to the decompressor component through the standard `SetInfo` mechanism of the Sound Manager.

```
struct SoundSlopeAndInterceptRecord {
    Float64 slope;
    Float64 intercept;
    Float64 minClip;
    Float64 maxClip;
};
typedef struct SoundSlopeAndInterceptRecord SoundSlopeAndInterceptRecord;
```

### siDecompressionParam atom ('wave')

---

A second extension is the `siDecompressionParam` atom, which provides the ability to store data specific to a given audio decompressor in the `SoundDescription` record. Some audio decompression algorithms, such as Microsoft's ADPCM, require a set of out-of-band values to configure the decompressor. These are stored in an atom of type `siDecompressionParam`.

This atom contains other atoms with audio decompressor settings and is a required extension to the sound sample description for MPEG-4 audio. A 'wave' chunk for 'mp4a' typically contains (in order) at least a 'frma' atom, an 'mp4a' atom, an 'esds' atom, and a terminator atom.

The contents of other `siDecompressionParam` atoms are dependent on the audio decompressor.

#### Size

An unsigned 32-bit integer holding the size of the decompression parameters atom.

**Type**

An unsigned 32-bit field containing the four-character code 'wave'.

**Extension atoms**

Atoms containing the necessary out-of-band decompression parameters for the sound decompressor. For MPEG-4 audio ('mp4a'), this includes elementary stream descriptor ('esds'), format ('frma'), and terminator (0x00000000) atoms.

**Format atom ('frma')**

---

This atom shows the data format of the stored sound media.

**Size**

An unsigned 32-bit integer holding the size of the format atom.

**Type**

An unsigned 32-bit field containing the four-character code 'frma'.

**Data format**

The value of this field is copied from the data-format field of the Sample Description Entry.

**Terminator atom (0x00000000)**

---

This atom is present to indicate the end of the sound description. It contains no data, and has a type field of zero (0x00000000) instead of a four-character code.

**Size**

An unsigned 32-bit integer holding the size of the decompression parameters atom (always set to 8).

**Type**

An unsigned 32-bit integer set to zero (0x00000000). This is a rare instance in which the type field is *not* a four-character ASCII code.

**MPEG-4 Elementary Stream Descriptor ('esds') Atom**

---

This atom is a required extension to the sound sample description for MPEG-4 audio. This atom contains an elementary stream descriptor, which is defined in ISO/IEC FDIS 14496.

**Size**

An unsigned 32-bit integer holding the size of the elementary stream descriptor atom

**Type**

An unsigned 32-bit field containing the four-character code 'esds'

**Version**

An unsigned 32-bit field set to zero.

**Elementary Stream Descriptor**

An elementary stream descriptor for MPEG-4 audio, as defined in the MPEG-4 specification ISO/IEC 14496.

## Sound Sample Data

---

The format of data stored in sound samples is completely dependent on the type of the compressed data stored in the sound sample description. The following sections discuss some of the formats supported by QuickTime.

### Uncompressed 8-Bit Sound

---

Eight-bit audio is stored in offset-binary encodings. If the data is in stereo, the left and right channels are interleaved.

### Uncompressed 16-Bit Sound

---

Sixteen-bit audio may be stored in two's-complement encodings. If the data is in stereo, the left and right channels are interleaved.

### IMA, uLaw, and aLaw

---

- IMA 4:1

The IMA encoding scheme is based on a standard developed by the International Multimedia Association for pulse code modulation (PCM) audio compression. QuickTime uses a slight variation of the format to allow for random access. IMA is a 16-bit audio format which supports 4:1 compression. It is defined as follows:

```
kIMACompression = FOUR_CHAR_CODE('ima4'), /*IMA 4:1*/
```

- uLaw 2:1 and aLaw 2:1

The uLaw (mu-law) encoding scheme is used on North American and Japanese phone systems, and is coming into use for voice data interchange, and in PBXs, voice-mail systems, and Internet talk radio (via MIME). In uLaw encoding, 14 bits of linear sample data are reduced to 8 bits of logarithmic data.

The aLaw encoding scheme is used in Europe and the rest of the world.

The kULawCompression and the kALawCompression formats are typically found in .au formats.

### Floating-Point Formats

---

Both kFloat32Format and kFloat64Format are floating-point uncompressed formats. Depending upon codec-specific data associated with the sample description, the floating-point values may be in big-endian (network) or little-endian (Intel) byte order. This differs from the 16-bit formats, where there is a single format for each endian layout.

### 24- and 32-Bit Integer Formats

---

Both k24BitFormat and k32BitFormat are integer uncompressed formats. Depending upon codec-specific data associated with the sample description, the floating-point values may be in big-endian (network) or little-endian (Intel) byte order.

## kMicrosoftADPCMFormat and kDVIIIntelIMAFormat Sound Codecs

---

The `kMicrosoftADPCMFormat` and the `kDVIIIntelIMAFormat` codec provide QuickTime interoperability with AVI and WAV files. The four-character codes used by Microsoft for their formats are numeric. To construct a QuickTime-supported codec format of this type, the Microsoft numeric ID is taken to generate a four-character code of the form 'msxx' where *xx* takes on the numeric ID.

## kDVAudioFormat Sound Codec

---

The DV audio sound codec, `kDVAudioFormat`, decodes audio found in a DV stream. Since a DV frame contains both video and audio, this codec knows how to skip video portions of the frame and only retrieve the audio portions. Likewise, the video codec skips the audio portions and renders only the image.

## kQDesignCompression Sound Codec

---

The `kQDesignCompression` sound codec is the QDesign 1 (pre-QuickTime 4) format. Note that there is also a QDesign 2 format whose four-character code is 'QDM2'.

## MPEG-1 Layer 3 (MP3) Codecs

---

The QuickTime MPEG layer 3 (MP3) codecs come in two particular flavors, as shown in [Table 3-7](#) (page 118). The first (`kMPEGLayer3Format`) is used exclusively in the constant bitrate (CBR) case (pre-QuickTime 4). The other (`kFullMPEGLay3Format`) is used in both the CBR and variable bitrate (VBR) cases. Note that they are the same codec underneath.

## MPEG-4 Audio

---

MPEG-4 audio is stored as a sound track with data format 'mp4a' and certain additions to the sound sample description and sound track atom. Specifically:

- The compression ID is set to -2 and redefined sample tables are used (see [“Redefined Sample Tables”](#) (page 121)).
- The sound sample description includes an `siDecompressionParam` atom (see [“siDecompressionParam atom \('wave\)’”](#) (page 122)). The `siDecompressionParam` atom includes:
  - An MPEG-4 elementary stream descriptor extension atom (see [“MPEG-4 Elementary Stream Descriptor \('esds'\) Atom”](#) (page 123)).
  - The inclusion of a format atom is strongly recommended. See [“Format atom \('frma\)’”](#) (page 123).
  - The last atom in the `siDecompressionParam` atom must be a terminator atom. See [“Terminator atom \(0x00000000\)’”](#) (page 123).
- Other atoms may be present as well; unknown atoms should be ignored.

The audio data is stored as an elementary MPEG-4 audio stream, as defined in ISO/IEC specification 14496-1.

## Formats Not Currently in Use: MACE 3:1 and 6:1

---

These compression formats are obsolete: MACE 3:1 and 6:1.

These are 8-bit sound codec formats, defined as follows:

```
kMACE3Compression = FOUR_CHAR_CODE('MAC3'), /*MACE 3:1*/
kMACE6Compression = FOUR_CHAR_CODE('MAC6'), /*MACE 6:1*/
```

## Timecode Media

---

Timecode media is used to store time code data in QuickTime movies. It has a media type of 'tmcd'.

### Timecode Sample Description

---

The timecode sample description contains information that defines how to interpret time code media data. This sample description is based on the standard sample description header, as described in “[Sample Description Atoms](#)” (page 78).

The data format field in the sample description is always set to 'tmcd'.

The timecode media handler also adds some of its own fields to the sample description.

#### Reserved

A 32-bit integer that is reserved for future use. Set this field to 0.

#### Flags

A 32-bit integer containing flags that identify some timecode characteristics. The following flags are defined.

##### Drop frame

Indicates whether the timecode is drop frame. Set it to 1 if the timecode is drop frame. This flag's value is 0x0001.

##### 24 hour max

Indicates whether the timecode wraps after 24 hours. Set it to 1 if the timecode wraps. This flag's value is 0x0002.

##### Negative times OK

Indicates whether negative time values are allowed. Set it to 1 if the timecode supports negative values. This flag's value is 0x0004.

##### Counter

Indicates whether the time value corresponds to a tape counter value. Set it to 1 if the timecode values are tape counter values. This flag's value is 0x0008.

#### Time scale

A 32-bit integer that specifies the time scale for interpreting the frame duration field.

**Frame duration**

A 32-bit integer that indicates how long each frame lasts in real time.

**Number of frames**

An 8-bit integer that contains the number of frames per second for the timecode format. If the time is a counter, this is the number of frames for each counter tick.

**Reserved**

A 24-bit quantity that must be set to 0.

**Source reference**

A user data atom containing information about the source tape. The only currently used user data list entry is the 'name' type. This entry contains a text item specifying the name of the source tape.

## Timecode Media Information Atom

---

The timecode media also requires a media information atom. This atom contains information governing how the timecode text is displayed. This media information atom is stored in a base media information atom (see “[Base Media Information Atoms](#)” (page 70) for more information). The type of the timecode media information atom is 'tcmi'.

The timecode media information atom contains the following fields:

**Size**

A 32-bit integer that specifies the number of bytes in this time code media information atom.

**Type**

A 32-bit integer that identifies the atom type; this field must be set to 'tcmi'.

**Version**

A 1-byte specification of the version of this timecode media information atom.

**Flags**

A 3-byte space for timecode media information flags. Set this field to 0.

**Text font**

A 16-bit integer that indicates the font to use. Set this field to 0 to use the system font. If the font name field contains a valid name, ignore this field.

**Text face**

A 16-bit integer that indicates the font's style. Set this field to 0 for normal text. You can enable other style options by using one or more of the following bit masks:

0x0001 Bold

0x0002 Italic

0x0004 Underline

0x0008 Outline

0x0010 Shadow

0x0020 Condense

0x0040 Extend

**Text size**

A 16-bit integer that specifies the point size of the time code text.

**Text color**

A 48-bit RGB color value for the timecode text.

**Background color**

A 48-bit RGB background color for the timecode text.

**Font name**

A Pascal string specifying the name of the timecode text's font.

## Timecode Sample Data

---

There are two different sample data formats used by timecode media.

If the Counter flag is set to 1 in the timecode sample description, the sample data is a counter value. Each sample contains a 32-bit integer counter value.

If the Counter flag is set to 0 in the timecode sample description, the sample data format is a timecode record, as follows.

**Hours**

An 8-bit unsigned integer that indicates the starting number of hours.

**Negative**

A 1-bit value indicating the time's sign. If bit is set to 1, the timecode record value is negative.

**Minutes**

A 7-bit integer that contains the starting number of minutes.

**Seconds**

An 8-bit unsigned integer indicating the starting number of seconds.

**Frames**

An 8-bit unsigned integer that specifies the starting number of frames. This field's value cannot exceed the value of the number of frames field in the timecode sample description.



## Text Media

---

Text media is used to store text data in QuickTime movies. It has a media type of 'text'.

### Text Sample Description

---

The text sample description contains information that defines how to interpret text media data. This sample description is based on the standard sample description header, as described in [“Sample Description Atoms”](#) (page 78).

The data format field in the sample description is always set to 'text'.

The text media handler also adds some of its own fields to the sample description.

### Display flags

A 32-bit integer containing flags that describe how the text should be drawn. The following flags are defined.

#### Don't auto scale

Controls text scaling. If this flag is set to 1, the text media handler reflows the text instead of scaling when the track is scaled. This flag's value is 0x0002.

#### Use movie background color

Controls background color. If this flag is set to 1, the text media handler ignores the background color field in the text sample description and uses the movie's background color instead. This flag's value is 0x0008.

#### Scroll in

Controls text scrolling. If this flag is set to 1, the text media handler scrolls the text until the last of the text is in view. This flag's value is 0x0020.

#### Scroll out

Controls text scrolling. If this flag is set to 1, the text media handler scrolls the text until the last of the text is gone. This flag's value is 0x0040.

#### Horizontal scroll

Controls text scrolling. If this flag is set to 1, the text media handler scrolls the text horizontally; otherwise, it scrolls the text vertically. This flag's value is 0x0080.

#### Reverse scroll

Controls text scrolling. If this flag is set to 1, the text media handler scrolls down (if scrolling vertically) or backward (if scrolling horizontally; note that horizontal scrolling also depends upon text justification). This flag's value is 0x0100.

#### Continuous scroll

Controls text scrolling. If this flag is set to 1, the text media handler displays new samples by scrolling out the old ones. This flag's value is 0x0200.

#### Drop shadow

Controls drop shadow. If this flag is set to 1, the text media handler displays the text with a drop shadow. This flag's value is 0x1000.

#### Anti-alias

Controls anti-aliasing. If this flag is set to 1, the text media handler uses anti-aliasing when drawing text. This flag's value is 0x2000.

#### Key text

Controls background color. If this flag is set to 1, the text media handler does not display the background color, so that the text overlay background tracks. This flag's value is 0x4000.

### Text justification

A 32-bit integer that indicates how the text should be aligned. Set this field to 0 for left-justified text, to 1 for centered text, and to -1 for right-justified text.

**Background color**

A 48-bit RGB color that specifies the text's background color.

**Default text box**

A 64-bit rectangle that specifies an area to receive text (top, left, bottom, right). Typically this field is set to all zeros.

**Reserved**

A 64-bit value that must be set to 0.

**Font number**

A 16-bit value that must be set to 0.

**Font face**

A 16-bit integer that indicates the font's style. Set this field to 0 for normal text. You can enable other style options by using one or more of the following bit masks:

0x0001 Bold

0x0002 Italic

0x0004 Underline

0x0008 Outline

0x0010 Shadow

0x0020 Condense

0x0040 Extend

**Reserved**

An 8-bit value that must be set to 0.

**Reserved**

A 16-bit value that must be set to 0.

**Foreground color**

A 48-bit RGB color that specifies the text's foreground color.

**Text name**

A Pascal string specifying the name of the font to use to display the text.

## Text Sample Data

---

The format of the text data is a 16-bit length word followed by the actual text. The length word specifies the number of bytes of text, not including the length word itself. Following the text, there may be one or more atoms containing additional information for drawing and searching the text.

[Table 3-8](#) (page 132) lists the currently defined text sample extensions.

**Table 3-8** Text sample extensions

Text sample extension	Description
'styl'	Style information for the text. Allows you to override the default style in the sample description or to define more than one style for a sample. The data is a TextEdit style scrap.
'ftab'	Table of font names. Each table entry contains a font number (stored in a 16-bit integer) and a font name (stored in a Pascal string). This atom is required if the 'styl' atom is present.
'hlit'	Highlight information. The atom data consists of two 32-bit integers. The first contains the starting offset for the highlighted text, and the second has the ending offset. A highlight sample can be in a key frame or in a differenced frame. When it's used in a differenced frame, the sample should contain a zero-length piece of text.
'hclr'	Highlight color. This atom specifies the 48-bit RGB color to use for highlighting.
'drpo'	Drop shadow offset. When the display flags indicate drop shadow style, this atom can be used to override the default drop shadow placement. The data consists of two 16-bit integers. The first indicates the horizontal displacement of the drop shadow, in pixels; the second, the vertical displacement.
'drpt'	Drop shadow transparency. The data is a 16-bit integer between 0 and 256 indicating the degree of transparency of the drop shadow. A value of 256 makes the drop shadow completely opaque.
'imag'	Image font data. This atom contains two more atoms. An 'idat' atom contains compressed image data to be used to draw the text when the required fonts are not available. An 'idsc' atom contains a video sample description describing the format of the compressed image data.
'metr'	Image font highlighting. This atom contains metric information that governs highlighting when an 'imag' atom is used for drawing.

## Hypertext and Wired Text

---

Hypertext is used as an action that takes you to a Web URL; like a Web URL, it appears blue and underlined. Hypertext is stored in a text track sample atom stream as type 'htxt'. The same mechanism is used to store wired actions linked to text strings. A text string can be wired to act as a hypertext link when clicked or to perform any defined QuickTime wired action when clicked. For details on wired actions, see [“Wired Action Grammar”](#) (page 147).

The data stored is a `QTAtomContainer`. The root atom of hypertext in this container is a wired-text atom of type 'wtxt'. This is the parent for all individual hypertext objects.

For each hypertext item, the parent atom is of type 'htxt'. This is the atom container atom type. Two children of this atom that define the offset of the hypertext in the text stream are

```
kRangeStart      strt // unsigned long
```

```
kRangeEnd          end // unsigned long
```

Child atoms of the parent atom are the events of type `kQTEventType` and the ID of the event type. The children of these event atoms follow the same format as other wired events.

```
kQTEventType, (kQTEventMouseClicked, kQTEventMouseClickedEnd,
               kQTEventMouseClickedTriggerButton,
               kQTEventMouseEnter, kQTEventMouseExit)
...
kTextWiredObjectsAtomType, 1
  kHyperTextItemAtomType, 1..n
    kRangeStart, 1
      long
    kRangeEnd, 1
      long

  kAction // The known range of track movie sprite actions
```

## Music Media

---

Music media is used to store note-based audio data, such as MIDI data, in QuickTime movies. It has a media type of 'musi'.

### Music Sample Description

---

The music sample description uses the standard sample description header, as described in the section [“Sample Description Atoms”](#) (page 78).

The data format field in the sample description is always set to 'musi'. The music media handler adds an additional 32-bit integer field to the sample description containing flags. Currently no flags are defined, and this field should be set to 0.

Following the flags field, there may be appended data in the QuickTime music format. This data consists of part-to-instrument mappings in the form of General events containing note requests. One note request event should be present for each part that will be used in the sample data.

### Music Sample Data

---

The sample data for music samples consists entirely of data in the QuickTime music format. Typically, up to 30 seconds of notes are grouped into a single sample.

## MPEG-1 Media

---

MPEG-1 media is used to store MPEG-1 video streams, MPEG-1, layer 2 audio streams, and multiplexed MPEG-1 audio and video streams in QuickTime movies. It has a media type of 'MPEG'.

### MPEG-1 Sample Description

---

The MPEG-1 sample description uses the standard sample description header, as described in [“Sample Description Atoms”](#) (page 78).

The data format field in the sample description is always set to 'MPEG'. The MPEG-1 media handler adds no additional fields to the sample description.

**Note:** This data format is not used for MPEG-1, layer 3 audio, however (see [“MPEG-1 Layer 3 \(MP3\) Codecs”](#) (page 125)).

### MPEG-1 Sample Data

---

Each sample in an MPEG-1 media is an entire MPEG-1 stream. This means that a single MPEG-1 sample may be several hundred megabytes in size. The MPEG-1 encoding used by QuickTime corresponds to the ISO standard, as described in ISO document CD 11172.

## Sprite Media

---

Sprite media is used to store character-based animation data in QuickTime movies. It has a media type of 'sprt'.

### Sprite Sample Description

---

The sprite sample description uses the standard sample description header, as described in [“Sample Description Atoms”](#) (page 78).

The data format field in the sample description is always set to 'sprt'. The sprite media handler adds no additional fields to the sample description.

### Sprite Sample Data

---

All sprite samples are stored in QT atom structures. The sprite media uses both key frames and differenced frames. The key frames contain all of the sprite's image data, and the initial settings for each of the sprite's properties.

A key frame always contains a shared data atom of type 'dflt'. This atom contains data to be shared between the sprites, consisting mainly of image data and sample descriptions. The shared data atom contains a single sprite image container atom, with an atom type value of 'imct' and an ID value of 1.

The sprite image container atom stores one or more sprite image atoms of type 'imag'. Each sprite image atom contains an image sample description immediately followed by the sprite's compressed image data. The sprite image atoms should have ID numbers starting at 1 and counting consecutively upward.

The key frame also must contain definitions for each sprite in atoms of type 'sprt'. Sprite atoms should have ID numbers start at 1 and count consecutively upward. Each sprite atom contains a list of properties. [Table 3-9](#) (page 135) shows all currently defined sprite properties.

**Table 3-9** Sprite properties

Property name	Value	Description
kSpriteProperty-Matrix	1	Describes the sprite's location and scaling within its sprite world or sprite track. By modifying a sprite's matrix, you can modify the sprite's location so that it appears to move in a smooth path on the screen or so that it jumps from one place to another. You can modify a sprite's size, so that it shrinks, grows, or stretches. Depending on which image compressor is used to create the sprite images, other transformations, such as rotation, may be supported as well. Translation-only matrices provide the best performance.
kSpriteProperty-Visible	4	Specifies whether or not the sprite is visible. To make a sprite visible, you set the sprite's visible property to true.
kSpritePropertyLayer	5	Contains a 16-bit integer value specifying the layer into which the sprite is to be drawn. Sprites with lower layer numbers appear in front of sprites with higher layer numbers. To designate a sprite as a background sprite, you should assign it the special layer number <code>kBackgroundSpriteLayerNum</code> .
kSpriteProperty-GraphicsMode	6	Specifies a graphics mode and blend color that indicates how to blend a sprite with any sprites behind it and with the background. To set a sprite's graphics mode, you call <code>SetSpriteProperty</code> , passing a pointer to a <code>ModifierTrackGraphicsModeRecord</code> structure.
kSpriteProperty-ActionHandlingSprite-ID	8	Specifies another sprite by ID that delegates QT events.
kSpriteProperty-ImageIndex	100	Contains the atom ID of the sprite's image atom.

The override sample differs from the key frame sample in two ways. First, the override sample does not contain a shared data atom. All shared data must appear in the key frame. Second, only those sprite properties that change need to be specified. If none of a sprite's properties change in a given frame, then the sprite does not need an atom in the differenced frame.

The override sample can be used in one of two ways: combined, as with video key frames, to construct the current frame; or the current frame can be derived by combining only the key frame and the current override sample.

Refer to the section “[Sprite Track Media Format](#)” (page 137) for information on how override samples are indicated in the file, using `kSpriteTrackPropertySampleFormat` and the default behavior of the `kKeyFrameAndSingleOverride` format.

## Sprite Track Properties

---

In addition to defining properties for individual sprites, you can also define properties that apply to an entire sprite track. These properties may override default behavior or provide hints to the sprite media handler. The following sprite track properties are supported:

- The `kSpriteTrackPropertyBackgroundColor` property specifies a background color for the sprite track. The background color is used for any area that is not covered by regular sprites or background sprites. If you do not specify a background color, the sprite track uses black as the default background color.
- The `kSpriteTrackPropertyOffscreenBitDepth` property specifies a preferred bit depth for the sprite track’s offscreen buffer. The allowable values are 8 and 16. To save memory, you should set the value of this property to the minimum depth needed. If you do not specify a bit depth, the sprite track allocates an offscreen buffer with the depth of the deepest intersecting monitor.
- The `kSpriteTrackPropertySampleFormat` property specifies the sample format for the sprite track. If you do not specify a sample format, the sprite track uses the default format, `kKeyFrameAndSingleOverride`.

To specify sprite track properties, you create a single QT atom container and add a leaf atom for each property you want to specify. To add the properties to a sprite track, you call the media handler function `SetMediaPropertyAtom`. To retrieve a sprite track’s properties, you call the media handler function `GetMediaPropertyAtom`.

The sprite track properties and their corresponding data types are listed in [Table 3-10](#) (page 136).

**Table 3-10** Sprite track properties

Atom type	Atom ID	Leaf data type
<code>kSpriteTrackPropertyBackgroundColor</code>	1	<code>RGBColor</code>
<code>kSpriteTrackPropertyOffscreenBitDepth</code>	1	unsigned short
<code>kSpriteTrackPropertySampleFormat</code>	1	long
<code>kSpriteTrackPropertyHasActions</code>	1	Boolean
<code>kSpriteTrackPropertyQTIdleEventsFrequency</code>	1	<code>UInt32</code>
<code>kSpriteTrackPropertyVisible</code>	1	Boolean
<code>kSpriteTrackPropertyScaleSpritesToScaleWorld</code>	1	Boolean



**Note:** When pasting portions of two different tracks together, the Movie Toolbox checks to see that all sprite track properties match. If, in fact, they do match, the paste results in a single sprite track instead of two.

## Sprite Track Media Format

The sprite track media format is hierarchical and based on QT atoms and atom containers. A sprite track is defined by one or more key frame samples, each followed by any number of override samples. A key frame sample and its subsequent override samples define a scene in the sprite track. A key frame sample is a QT atom container that contains atoms defining the sprites in the scene and their initial properties. The override samples are other QT atom containers that contain atoms that modify sprite properties, thereby animating the sprites in the scene. In addition to defining properties for individual sprites, you can also define properties that apply to an entire sprite track.

Figure 3-13 (page 137) shows the high-level structure of a sprite track key frame sample. Each atom in the atom container is represented by its atom type, atom ID, and, if it is a leaf atom, the type of its data.

**Figure 3-13** A key frame sample atom container

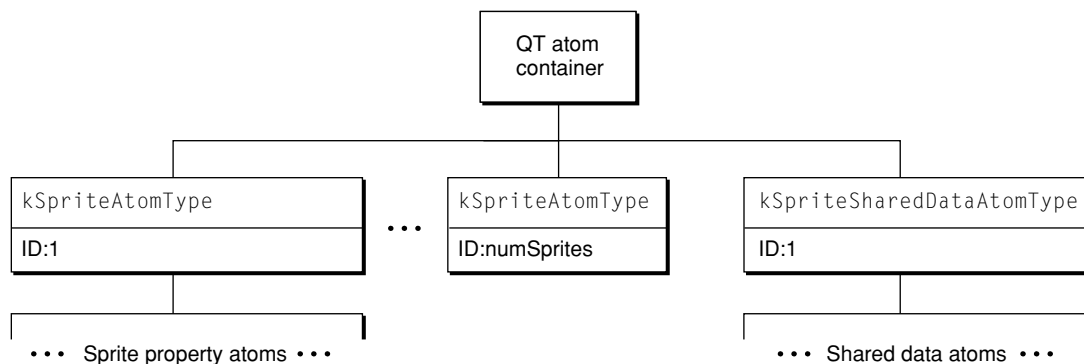

The QT atom container contains one child atom for each sprite in the key frame sample. Each sprite atom has a type of `kSpriteAtomType`. The sprite IDs are numbered from 1 to the number of sprites defined by the key frame sample (`numSprites`).

Each sprite atom contains leaf atoms that define the properties of the sprite, as shown in Figure 3-14 (page 138). For example, the `kSpritePropertyLayer` property defines a sprite's layer. Each sprite property atom has an atom type that corresponds to the property and an ID of 1.

Figure 3-14 Atoms that describe a sprite and its properties

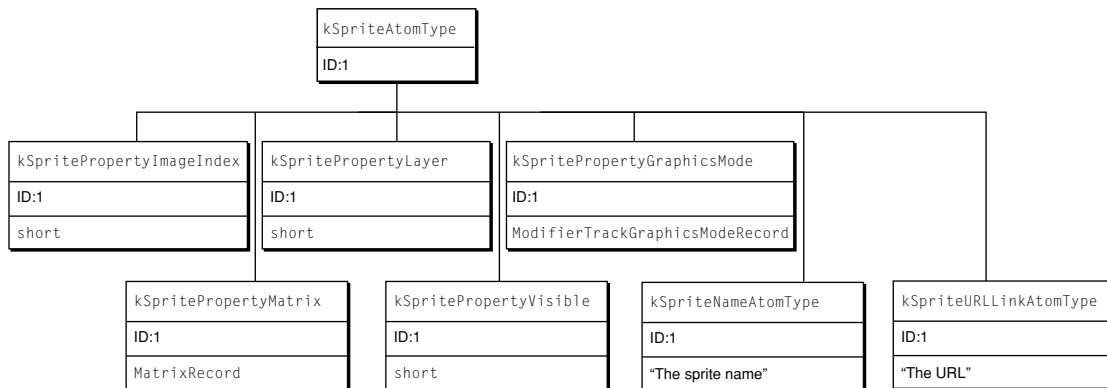

In addition to the sprite atoms, the QT atom container contains one atom of type `kSpriteSharedDataAtomType` with an ID of 1. The atoms contained by the shared data atom describe data that is shared by all sprites. The shared data atom contains one atom of type `kSpriteImagesContainerAtomType` with an ID of 1 (Figure 3-15 (page 138)).

The image container atom contains one atom of type `kImageAtomType` for each image in the key frame sample. The image atom IDs are numbered from 1 to the number of images (`numImages`). Each image atom contains a leaf atom that holds the image data (type `kSpriteImageDataAtomType`) and an optional leaf atom (type `kSpriteNameAtomType`) that holds the name of the image.

Figure 3-15 Atoms that describe sprite images

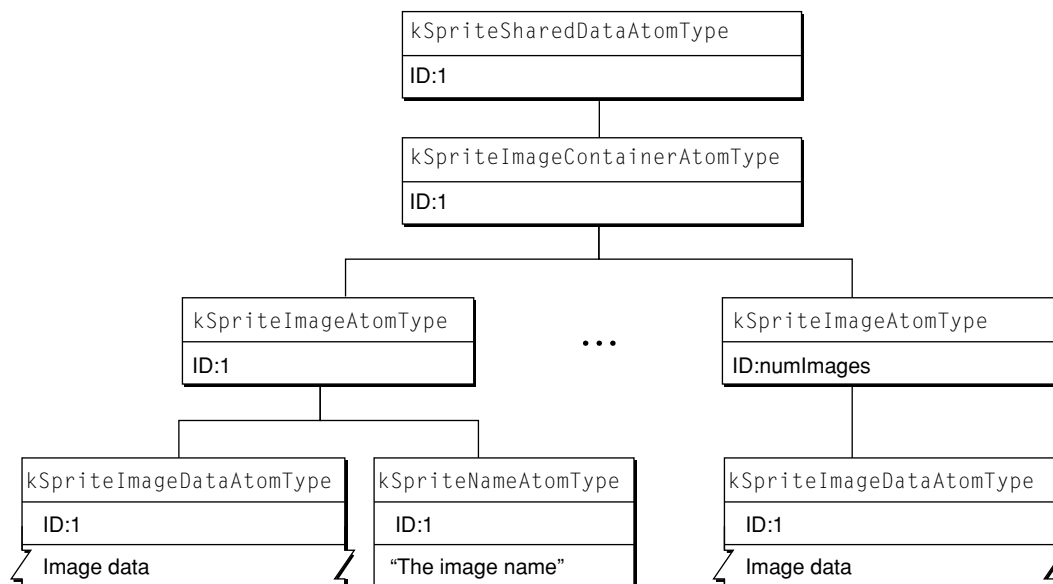

## Sprite Media Format Atoms

---

The sprite track's sample format enables you to store the atoms necessary to describe action lists that are executed in response to QuickTime events. “[QT Atom Container Description Key](#)” (page 145) defines a grammar for constructing valid action sprite samples, which may include complex expressions.

Both key frame samples and override samples support the sprite action atoms. Override samples override actions at the QuickTime event level. In effect, what you do by overriding is to completely replace one event handler and all its actions with another. The sprite track's `kSpriteTrackPropertySampleFormat` property has no effect on how actions are performed. The behavior is similar to the default `kKeyFrameAndSingleOverride` format where, if in a given override sample there is no handler for the event, the key frame's handler is used, if there is one.

## Sprite Media Format Extensions

---

This section describes some of the atom types and IDs used to extend the sprite track's media format, thus enabling action sprite capabilities.

A complete description of the grammar for sprite media handler samples, including action sprite extensions, is included in the section “[Sprite Media Handler Track Properties QT Atom Container Format](#)” (page 146).

**Important:** Some sprite track property atoms were added in QuickTime 4. In particular, you must set the `kSpriteTrackPropertyHasActions` track property in order for your sprite actions to be executed.

## Sprite Track Property Atoms

---

The following constants represent atom types for sprite track properties. These atoms are applied to the whole track, not just to a single sample.

### Constant descriptions

`kSpriteTrackPropertyHasActions`

You must add an atom of this type with its leaf data set to `true` if you want the movie controller to execute the actions in your sprite track's media. The atom's leaf data is of type `Boolean`. The default value is `false`, so it is very important to add an atom of this type if you want interactivity to take place.

`kSpriteTrackPropertyQTIdleEventsFrequency`

You must add an atom of this type if you want the sprites in your sprite track to receive `kQTEventIdle` QuickTime events. The atom's leaf data is of type `UInt32`. The value is the minimum number of ticks that must pass before the next `QTIdle` event is sent. Each tick is

1/60th of one second. To specify “Idle as fast as possible,” set the value to 0. The default value is `kNoQTIdleEvents`, which means don’t send any idle events.

It is possible that for small idle event frequencies, the movie will not be able to keep up, in which case idle events will be sent as fast as possible.

Since sending idle events takes up some time, it is best to specify the largest frequency that produces the results that you desire, or `kNoQTIdleEvents` if you do not need them.

#### `kSpriteTrackPropertyVisible`

You can cause the entire sprite track to be invisible by setting the value of this `Boolean` property to `false`. This is useful for using a sprite track as a hidden button track—for example, placing an invisible sprite track over a video track would allow the characters in the video to be clickable. The default value is `visible` (`true`).

#### `kSpriteTrackPropertyScaleSpritesToScaleWorld`

You can cause each sprite to be rescaled when the sprite track is resized by setting the value of this `Boolean` property to `true`. Setting this property can improve the drawing performance and quality of a scaled sprite track. This is particularly useful for sprite images compressed with codecs that are resolution-independent, such as the Curve codec. The default value for this property is `false`.

## Atom Types

---

The following constants represent atom types for sprite media:

```
enum {
    kSpriteAtomType                = 'sprt',
    kSpriteImagesContainerAtomType = 'imct',
    kSpriteImageAtomType           = 'imag',
    kSpriteImageDataAtomType       = 'imda',
    kSpriteImageDataRefAtomType    = 'imre',
    kSpriteImageDataRefTypeAtomType = 'imrt',
    kSpriteImageGroupIDAtomType    = 'imgr',
    kSpriteImageRegistrationAtomType = 'imrg',
    kSpriteImageDefaultImageIndexAtomType = 'defi',
    kSpriteSharedDataAtomType      = 'dflt',
    kSpriteNameAtomType            = 'name',
    kSpriteImageNameAtomType       = 'name',
    kSpriteUsesImageIDsAtomType    = 'uses',
    kSpriteBehaviorsAtomType       = 'beha',
    kSpriteImageBehaviorAtomType   = 'imag',
    kSpriteCursorBehaviorAtomType  = 'crsr',
    kSpriteStatusStringsBehaviorAtomType = 'sstr',
    kSpriteVariablesContainerAtomType = 'vars',
    kSpriteStringVariableAtomType  = 'strv',
    kSpriteFloatingPointVariableAtomType = 'flov',
    kSpriteSharedDataAtomType      = 'dflt',
    kSpriteURLLinkAtomType         = 'url'
    kSpritePropertyMatrix          = 1
    kSpritePropertyVisible         = 4
    kSpritePropertyLayer           = 5
    kSpritePropertyGraphicsMode    = 6
    kSpritePropertyImageIndex      = 100
}
```

```

    kSpritePropertyBackgroundColor      = 101
    kSpritePropertyOffscreenBitDepth   = 102
    kSpritePropertySampleFormat        = 103
};

```

**Constant descriptions****kSpriteAtomType**

The atom is a parent atom that describes a sprite. It contains atoms that describe properties of the sprite. Optionally, it may also include an atom of type `kSpriteNameAtomType` that defines the name of the sprite.

**kSpriteImagesContainerAtomType**

The atom is a parent atom that contains atoms of type `kSpriteImageAtomType`.

**kSpriteImageAtomType**

The atom is a parent atom that contains an atom of type `kSpriteImageDataAtomType`. Optionally, it may also include an atom of type `kSpriteNameAtomType` that defines the name of the image.

**kSpriteImageDataAtomType**

The atom is a leaf atom that contains image data.

**kSpriteSharedDataAtomType**

The atom is a parent atom that contains shared sprite data, such as an atom container of type `kSpriteImagesContainerAtomType`.

**kSpriteNameAtomType**

The atom is a leaf atom that contains the name of a sprite or an image. The leaf data is composed of one or more ASCII characters.

**kSpritePropertyImageIndex**

A leaf atom containing the image index property which is of type `short`. This atom is a child atom of `kSpriteAtom`.

**kSpritePropertyLayer**

A leaf atom containing the layer property which is of type `short`. This atom is a child atom of `kSpriteAtom`.

**kSpritePropertyMatrix**

A leaf atom containing the matrix property which is of type `MatrixRecord`. This atom is a child atom of `kSpriteAtom`.

**kSpritePropertyVisible**

A leaf atom containing the visible property which is of type `short`. This atom is a child atom of `kSpriteAtom`.

**kSpritePropertyGraphicsMode**

A leaf atom containing the graphics mode property which is of type `ModifierTrackGraphicsModeRecord`. This atom is a child atom of `kSpriteAtom`.

**kSpritePropertyBackgroundColor**

A leaf atom containing the background color property which is of type `RGBColor`. This atom is used in a sprite track's `MediaPropertyAtom` atom container.

`kSpritePropertyOffscreenBitDepth`

A leaf atom containing the preferred offscreen bitdepth which is of type `short`. This atom is used in a sprite track's `MediaPropertyAtom` atom container.

`kSpritePropertySampleFormat`

A leaf atom containing the sample format property, which is of type `short`. This atom is used in a sprite track's `MediaPropertyAtom` atom container.

`kSpriteImageRegistrationAtomType`

Sprite images have a default registration point of 0, 0. To specify a different point, add an atom of type `kSpriteImageRegistrationAtomType` as a child atom of the `kSpriteImageAtomType` and set its leaf data to a `FixedPoint` value with the desired registration point.

`kSpriteImageGroupIDAtomType`

You must assign group IDs to sets of equivalent images in your key frame sample. For example, if the sample contains ten images where the first two images are equivalent, and the last eight images are equivalent, then you could assign a group ID of 1000 to the first two images, and a group ID of 1001 to the last eight images. This divides the images in the sample into two sets. The actual ID does not matter, it just needs to be a unique positive integer.

Each image in a sprite media key frame sample is assigned to a group. Add an atom of type `kSpriteImageGroupIDAtomType` as a child of the `kSpriteImageAtomType` atom and set its leaf data to a long containing the group ID.

**Important:** You must assign group IDs to your sprite sample if you want a sprite to display images with non-equivalent image descriptions (i.e., images with different dimensions).

For each of the following atom types (added to QuickTime 4)—except

`kSpriteBehaviorsAtomType`—you fill in the structure `QTSpriteButtonBehaviorStruct`, which contains a value for each of the four states.

`kSpriteBehaviorsAtomType`

This is the parent atom of `kSpriteImageBehaviorAtomType`, `kSpriteCursorBehaviorAtomType`, and `kSpriteStatusStringsBehaviorAtomType`.

`kSpriteImageBehaviorAtomType`

Specifies the `imageIndex`.

`kSpriteCursorBehaviorAtomType`

Specifies the `cursorID`.

`kSpriteStatusStringsBehaviorAtomType`

Specifies an ID of a string variable contained in a sprite track to display in the status area of the browser.

**Note:** All sprite media—specifically the leaf data in the QT atom containers for sample and sprite track properties—should be written in big-endian format.

#### kSpriteUsesImageIDsAtomType

This atom allows a sprite to specify which images it uses—in other words, the subset of images that its `imageIndex` property can refer to.

You add an atom of type `kSpriteUsesImageIDsAtomType` as a child of a `kSpriteAtomType` atom, setting its leaf data to an array of QT atom IDs. This array contains the IDs of the images used, not the indices.

Although QuickTime does not currently use this atom internally, tools that edit sprite media can use the information provided to optimize certain operations, such as cut, copy, and paste.

#### kSpriteImageRegistrationAtomType

Sprite images have a default registration point of 0, 0. To specify a different point, you add an atom of type `kSpriteImageRegistrationAtomType` as a child atom of the `kSpriteImageAtomType` and set its leaf data to a `FixedPoint` value with the desired registration point.

#### kSpriteImageGroupIDAtomType

You must assign group IDs to sets of equivalent images in your key frame sample. For example, if the sample contains ten images where the first two images are equivalent, and the last eight images are equivalent, then you could assign a group ID of 1000 to the first two images, and a group ID of 1001 to the last eight images. This divides the images in the sample into two sets. The actual ID does not matter; it just needs to be a unique positive integer.

Each image in a sprite media key frame sample is assigned to a group. You add an atom of type `kSpriteImageGroupIDAtomType` as a child of the `kSpriteImageAtomType` atom and set its leaf data to a long containing the group ID.

**Important:** You must assign group IDs to your sprite sample if you want a sprite to display images with non-equivalent image descriptions (that is, images with different dimensions).

You use the following atom types, which were added to QuickTime 4, to specify that an image is referenced and how to access it.

#### kSpriteImageDataRefAtomType

Add this atom as a child of the `kSpriteImageAtomType` atom instead of a `kSpriteImageDataAtomType`. Its ID should be 1. Its data should contain the data reference (similar to the `dataRef` parameter of `GetDataHandler`).

#### kSpriteImageDataRefTypeAtomType

Add this atom as a child of the `kSpriteImageAtomType` atom. Its ID should be 1. Its data should contain the data reference type (similar to the `dataRefType` parameter of `GetDataHandler`).

#### kSpriteImageDefaultImageIndexAtomType

You may optionally add this atom as a child of the `kSpriteImageAtomType` atom. Its ID should be 1. Its data should contain a short, which specifies an image index of a traditional image to use while waiting for the referenced image to load.

The following constants represent formats of a sprite track. The value of the constant indicates how override samples in a sprite track should be interpreted. You set a sprite track's format by creating a `kSpriteTrackPropertySampleFormat` atom.

```
enum {
    kKeyFrameAndSingleOverride    = 1L << 1,
    kKeyFrameAndAllOverrides      = 1L << 2
};
```

#### Constant descriptions

`kKeyFrameAndSingleOverride`

The current state of the sprite track is defined by the most recent key frame sample and the current override sample. This is the default format.

`kKeyFrameAndAllOverrides`

The current state of the sprite track is defined by the most recent key frame sample and all subsequent override samples up to and including the current override sample.

## Sprite Button Behaviors

---

In QuickTime 4 and later, sprites in a sprite track can specify simple button behaviors. These behaviors can control the sprite's image, the system cursor, and the status message displayed in a Web browser. They also provide a shortcut for a common set of actions that may result in more efficient QuickTime movies.

Button behaviors can be added to a sprite. These behaviors are intended to make the common task of creating buttons in a sprite track easy—you basically just fill in a template.

Three types of behaviors are available; you may choose one or more behaviors. Each change a type of property associated with a button and are triggered by the mouse states `notOverNotPressed`, `overNotPressed`, `overPressed`, and `notOverPressed`. The three properties changed are:

- The sprite's `imageIndex` value
- The ID of a cursor to be displayed
- The ID of a status string variable displayed in the URL status area of a Web browser.

Setting a property's value to `-1` means don't change it.

**Note:** The cursor is automatically set back to the default system cursor when leaving a sprite.

The sprite track handles letting one sprite act as an active button at a time.

The behaviors are added at the beginning of the sprite's list of actions, so they may be overridden by actions if desired.

To use the behaviors, you fill in the new atoms as follows, using the description key specified in "[QT Atom Container Description Key](#)" (page 145):

```
kSpriteAtomType
```



```

<kSpriteBehaviorsAtomType>, 1

    <kSpriteImageBehaviorAtomType>
        [QTSpriteButtonBehaviorStruct]
    <kSpriteCursorBehaviorAtomType>
        [QTSpriteButtonBehaviorStruct]
    <kSpriteStatusStringsBehaviorAtomType>
        [QTSpriteButtonBehaviorStruct]

```

## QT Atom Container Description Key

---

Because QT atom container–based data structures are widely used in QuickTime, a description key is presented here. Its usage is illustrated in the following sections, “[Sprite Media Handler Track Properties QT Atom Container Format](#)” (page 146) and “[Sprite Media Handler Sample QT Atom Container Formats](#)” (page 146).

```

[(QTAtomFormatName)] =
    atomType_1, id, index
    data
    atomType_n, id, index
    data

```

The atoms may be required or optional:

```

// optional atom
// required atom
<atomType>
atomType

```

The atom ID may be a number if it is required to be a constant, or it may be a list of valid atom IDs, indicating that multiple atoms of this type are allowed.

```

3                // one atom with id of 3
(1..3)           // three atoms with id's of 1, 2, and 3
(1, 5, 7)        // three atoms with id's of 1, 5, and 7
(anyUniqueIDs)  // multiple atoms each with a unique id

```

The atom index may be a 1 if only one atom of this type is allowed, or it may be a range from 1 to some constant or variable.

```

1                // one atom of this type is allowed, index is always 1
(1..3)           // three atoms with indexes 1, 2, and 3
(1..numAtoms)   // numAtoms atoms with indexes of 1 to numAtoms

```

The data may be leaf data in which its data type is listed inside of brackets [], or it may be a nested tree of atoms.

```

[theDataType]   // leaf data of type theDataType
childAtoms      // a nested tree of atoms

```

Nested QTAtom format definitions [(AtomFormatName)] may appear in a definition.

## Sprite Media Handler Track Properties QT Atom Container Format

---

```
[(SpriteTrackProperties)]
  <kSpriteTrackPropertyBackgroundColor, 1, 1>
    [RGBColor]
  <kSpriteTrackPropertyOffscreenBitDepth, 1, 1>
    [short]
  <kSpriteTrackPropertySampleFormat, 1, 1>
    [long]
  <kSpriteTrackPropertyScaleSpritesToScaleWorld, 1, 1>
    [Boolean]
  <kSpriteTrackPropertyHasActions, 1, 1>
    [Boolean]
  <kSpriteTrackPropertyVisible, 1, 1>
    [Boolean]
  <kSpriteTrackPropertyQTIdleEventsFrequency, 1, 1>
    [UInt32]
```

## Sprite Media Handler Sample QT Atom Container Formats

---

```
[(SpriteKeySample)] =
  [(SpritePropertyAtoms)]
  [(SpriteImageAtoms)]
```

```
[(SpriteOverrideSample)] =
  [(SpritePropertyAtoms)]
```

```
[(SpriteImageAtoms)]
  kSpriteSharedDataAtomType, 1, 1
  <kSpriteVariablesContainerAtomType>, 1
    <kSpriteStringVariableAtomType>, (1..n) ID is SpriteTrack
      Variable ID to be set
      [CString]
    <kSpriteFloatingPointVariableAtomType>, (1..n) ID is
      SpriteTrack Variable ID to be set
      [float]

  kSpriteImagesContainerAtomType, 1, 1
    kSpriteImageAtomType, theImageID, (1 .. numImages)
      kSpriteImageDataAtomType, 1, 1
        [ImageData is ImageDescriptionHandle prepended to
          image data]
      <kSpriteImageRegistrationAtomType, 1, 1>
        [FixedPoint]
      <kSpriteImageNameAtomType, 1, 1>
        [pString]
      <kSpriteImageGroupIDAtomType, 1, 1>
        [long]
```

```

[ (SpritePropertyAtoms) ]
    <kQTEventFrameLoaded>, 1, 1
        [ (ActionListAtoms) ]
            <kCommentAtomType>, (anyUniqueIDs), (1..numComments)
                [CString]

    kSpriteAtomType, theSpriteID, (1 .. numSprites)
        <kSpritePropertyMatrix, 1, 1>
            [MatrixRecord]
        <kSpritePropertyVisible, 1, 1>
            [short]
        <kSpritePropertyLayer, 1, 1>
            [short]
        <kSpritePropertyImageIndex, 1, 1>
            [short]
        <kSpritePropertyGraphicsMode, 1, 1>
            [ModifierTrackGraphicsModeRecord]

    <kSpriteUsesImageIDsAtomType, 1, 1>
        [array of QTAtomID's, one per image used]

    <kSpriteBehaviorsAtomType>, 1

    <kSpriteImageBehaviorAtomType>
        [QTSpriteButtonBehaviorStruct]
    <kSpriteCursorBehaviorAtomType>
        [QTSpriteButtonBehaviorStruct]
    <kSpriteStatusStringsBehaviorAtomType>
        [QTSpriteButtonBehaviorStruct]

    <[ (SpriteActionAtoms) ]>

[ (SpriteActionAtoms) ] =
    kQTEventType, theQTEventType, (1 .. numEventTypes)
        [ (ActionListAtoms) ] //see the next section Wired Action
                               //Grammar for a description
    <kCommentAtomType>, (anyUniqueIDs), (1..numComments)
        [CString]

```

## Wired Action Grammar

---

The wired action grammar shown in this section allows QT event handlers to be expressed in a QuickTime movie. The sprite, text, VR, 3D, and Flash media handlers all support the embedding of QT event handlers in their media samples.

```

[ (ActionListAtoms) ] =
    kAction, (anyUniqueIDs), (1..numActions)
        kWhichAction 1, 1
            [long whichActionConstant]
        <kActionParameter> (anyUniqueIDs), (1..numParameters)
            [(parameterData)] ( whichActionConstant, paramIndex )
        // either leaf data or child atoms
        <kActionFlags> parameterID, (1..numParamsWithFlags)

```

```

        [long actionFlags]
        <kActionParameterMinValue> parameterID, (1.. numParamsWithMin)
            [data depends on param type]
        <kActionParameterMaxValue> parameterID, (1.. numParamsWithMax)
            [data depends on param type]
        [(ActionTargetAtoms)]

        <kCommentAtomType>, (anyUniqueIDs), (1..numComments)
            [CString]

[(ActionTargetAtoms)] =
    <kActionTarget>
        <kTargetMovie>
            [no data]
        <kTargetChildMovieTrackName>
            <PString childMovieTrackName>
        <kTargetChildMovieTrack>
            [ID]long childMovieTrackID]
        <kTargetChildMovieTrackIndex>
            [long childMovieTrackIndex]
        <kTargetChildMovieMovieName>
            [PString childMovieName]
        <kTargetChildMovieMovieID>
            [long childMovieID]
        <kTargetTrackName>
            [PString trackName]
        <kTargetTrackType>
            [OSType trackType]
        <kTargetTrackIndex>
            [long trackIndex]
            OR
            [(kExpressionAtoms)]
        <kTargetTrackID>
            [long trackID]
            OR
            [(kExpressionAtoms)]
        <kTargetSpriteName>
            [PString spriteName]
        <kTargetSpriteIndex>
            [short spriteIndex]
            OR
            [(kExpressionAtoms)]
        <kTargetSpriteID>
            [QTAtomID spriteIID]
            OR
            [(kExpressionAtoms)]
        <kTargetQD3DNamedObjectName>
            [CString objectName]

[(kExpressionAtoms)] =
    kExpressionContainerAtomType, 1, 1
    <kOperatorAtomType, theOperatorType, 1>
        kOperandAtomType, (anyUniqueIDs), (1..numOperands)
            [(OperandAtoms)]
    OR
    <kOperandAtomType, 1, 1>
        [(OperandAtoms)]
[(ActionTargetAtoms)] =

```

```

<kActionTarget>
    <kTargetMovieName>
        [Pstring MovieName]
    OR
    <kTargetMovieID>
        [long MovieID]
    OR
        [(kExpressionAtoms)]

[(OperandAtoms)] =
    <kOperandExpression> 1, 1
        [(kExpressionAtoms)] // allows for recursion
    OR
    <kOperandConstant> 1, 1
        [ float theConstant ]
    OR
    <kOperandSpriteTrackVariable> 1, 1
        [(ActionTargetAtoms)]
        kActionParameter, 1, 1
        [QTAtomID spriteVariableID]
    OR
    <kOperandKeyIsDown> 1, 1
        kActionParameter, 1, 1
        [UInt16 modifierKeys]
        kActionParameter, 2, 2
        [UInt8 asciiCharCode]
    OR
    <kOperandRandom> 1, 1
        kActionParameter, 1, 1
        [short minimum]
        kActionParameter, 2, 2
        [short maximum]
    OR
    <any other operand atom type>
        [(ActionTargetAtoms)]

```

The format for parameter data depends on the action and parameter index.

In most cases, the `kActionParameter` atom is a leaf atom containing data; for a few parameters, it contains child atoms.

`whichAction` corresponds to the action type that is specified by the leaf data of a `kWhichAction` atom.

`paramIndex` is the index of the parameter's `kActionParameter` atom.

```

[(parameterData)] ( whichAction, paramIndex ) =
{
    kActionMovieSetVolume:
        param1:    short volume

    kActionMovieSetRate
        param1:    Fixed rate

    kActionMovieSetLoopingFlags
        param1:    long loopingFlags

    kActionMovieGoToTime

```

```

    param1:    TimeValue time

kActionMovieGoToTimeByName
    param1:    Str255 timeName

kActionMovieGoToBeginning
    no params

kActionMovieGoToEnd
    no params

kActionMovieStepForward
    no params

kActionMovieStepBackward
    no params

kActionMovieSetSelection
    param1:    TimeValue startTime
    param2:    TimeValue endTime

kActionMovieSetSelectionByName
    param1:    Str255 startTimeName
    param2:    Str255 endTimeName

kActionMoviePlaySelection
    param1:    Boolean selectionOnly

kActionMovieSetLanguage
    param1:    long language

kActionMovieChanged
    no params

kActionTrackSetVolume
    param1:    short volume

kActionTrackSetBalance
    param1:    short balance

kActionTrackSetEnabled
    param1:    Boolean enabled

kActionTrackSetMatrix
    param1:    MatrixRecord matrix

kActionTrackSetLayer
    param1:    short layer

kActionTrackSetClip
    param1:    RgnHandle clip

kActionSpriteSetMatrix
    param1:    MatrixRecord matrix

kActionSpriteSetImageIndex
    param1:    short imageIndex

```

```

kActionSpriteSetVisible
    param1:    short visible

kActionSpriteSetLayer
    param1:    short layer

kActionSpriteSetGraphicsMode
    param1:    ModifierTrackGraphicsModeRecord graphicsMode

kActionSpritePassMouseToCodec
    no params

kActionSpriteClickOnCodec
    param1:    Point localLoc

kActionSpriteTranslate
    param1:    Fixed x
    param2:    Fixed y
    param3:    Boolean isRelative

kActionSpriteScale
    param1:    Fixed xScale
    param2:    Fixed yScale

kActionSpriteRotate
    param1:    Fixed degrees

kActionSpriteStretch
    param1:    Fixed p1x
    param2:    Fixed p1y
    param3:    Fixed p2x
    param4:    Fixed p2y
    param5:    Fixed p3x
    param6:    Fixed p3y
    param7:    Fixed p4x
    param8:    Fixed p4y

kActionQTVRSetPanAngle
    param1:    float panAngle

kActionQTVRSetTiltAngle
    param1:    float tiltAngle

kActionQTVRSetFieldOfView
    param1:    float fieldOfView

kActionQTVRShowDefaultView
    no params

kActionQTVRGoToNodeID
    param1:    UInt32 nodeID

kActionMusicPlayNote
    param1:    long sampleDescIndex
    param2:    long partNumber
    param3:    long delay
    param4:    long pitch

```

## Media Data Atom Types

```

        param5:    long velocity
        param6:    long duration

kActionMusicSetController
    param1:    long sampleDescIndex
    param2:    long partNumber
    param3:    long delay
    param4:    long controller
    param5:    long value

kActionCode
    param1:    [(CaseStatementActionAtoms)]

kActionWhile
    param1:    [(WhileStatementActionAtoms)]

kActionGoToURL
    param1:    CString urlLink

kActionSendQTEventToSprite
    param1:    [(SpriteTargetAtoms)]
    param2:    QTEventRecord theEvent

kActionDebugStr
    param1:    Str255 theMessageString

kActionPushCurrentTime
    no params

kActionPushCurrentTimeWithLabel
    param1:    Str255 theLabel

kActionPopAndGotoTopTime
    no params

kActionPopAndGotoLabeledTime
    param1:    Str255 theLabel

kActionSpriteTrackSetVariable
    param1:    QTAtomID variableID
    param2:    float value

kActionApplicationNumberAndString
    param1:    long aNumber
    param2:    Str255 aString
}

```

Both [(CaseStatementActionAtoms)] and [(WhileStatementActionAtoms)] are child atoms of a kActionParameter 1, 1 atom.

```

[(CaseStatementActionAtoms)] =
    kConditionalAtomType, (anyUniqueIDs), (1..numCases)
    [(kExpressionAtoms)]
    kActionListAtomType 1, 1
    [(ActionListAtoms)] // may contain nested conditional actions

[(WhileStatementActionAtoms)] =
    kConditionalAtomType, 1, 1

```



```

[(kExpressionAtoms)]
kActionListAtomType 1, 1
  [(ActionListAtoms)] // may contain nested conditional actions

```

## Flash Media

---

Flash is a vector-based graphics and animation technology designed for the Internet. As an authoring tool, Flash lets content authors and developers create a wide range of interactive vector animations. The files exported by this tool are called SWF (pronounced “swiff”) files. SWF files are commonly played back using Macromedia’s ShockWave plug-in. In an effort to establish Flash as an industrywide standard, Macromedia has published the SWF File Format and made the specification publicly available on its website at <http://www.macromedia.com/software/flash/open/spec/>.

The Flash media handler, introduced in QuickTime 4, allows a Macromedia Flash SWF 3.0 file to be treated as a track within a QuickTime movie. Thus, QuickTime 4 extends the SWF file format, enabling the execution of any of its wired actions. See “[Adding Wired Actions To a Flash Track](#)” (page 240) for an example of how to add wired actions.

Because a QuickTime movie may contain any number of tracks, multiple SWF tracks may be added to the same movie. The Flash media handler also provides support for an optimized case using the alpha channel graphics mode, which allows a Flash track to be composited cleanly over other tracks.

QuickTime supports all Flash actions except for the Flash load movie action. For example, when a Flash track in a QuickTime movie contains an action that goes to a particular Flash frame, QuickTime converts this to a wired action that goes to the QuickTime movie time in the corresponding Flash frame.

**Note:** As a time-based media playback format, QuickTime may drop frames when necessary to maintain its schedule. As a consequence, frames of a SWF file may be dropped during playback. If this is not satisfactory for your application, you can set the playback mode of the movie to Play All Frames, which will emulate the playback mode of ShockWave. QuickTime’s SWF file importer sets the Play All Frames mode automatically when adding a SWF file to an empty movie.

QuickTime support for Flash 3.0 also includes the DoFSCCommand mechanism. This allows JavaScript routines with a specific function prototype to be invoked with parameters passed from the Flash track. Refer to Macromedia’s Flash 3 documentation for more details on how to author a .SWF 3.0 file with a Flash FSCCommand.

## Tween Media

---

Tween media is used to store pairs of values to be interpolated between in QuickTime movies. These interpolated values modify the playback of other media types by using track references and track input maps. For example, a tween media could generate gradually changing relative volume levels to cause an audio track to fade out. It has a media type of 'tween'.

Every tween operation is based on a collection of one or more values from which a range of output values can be algorithmically derived. Each tween is assigned a time duration, and an output value can be generated for any time value within the duration. In the simplest kind of tween operation, a pair of values is provided as input and values between the two values are generated as output.

A tween track is a special track in a movie that is used exclusively as a modifier track. The data it contains, known as tween data, is used to generate values that modify the playback of other tracks, usually by interpolating values. The tween media handler sends these values to other media handlers; it never presents data.

## Tween Sample Description

---

The tween sample description uses the standard sample description header, as described in “[Sample Table Atoms](#)” (page 76).

The data format field in the sample description is always set to 'tween'. The tween media handler adds no additional fields to the sample description.

## Tween Sample Data

---

Tween sample data is stored in QT atom structures.

At the root level, there are one or more tween entry atoms; these atoms have an atom type value of 'tween'. Each tween entry atom completely describes one interpolation operation. These atoms should be consecutively numbered starting at 1, using the atom ID field.

Each tween entry atom contains several more atoms that describe how to perform the interpolation. The atom ID field in each of these atoms must be set to 1.

- Tween start atom (atom type is 'twst'). This atom specifies the time at which the interpolation is to start. The time is expressed in the media’s time coordinate system. If this atom is not present, the starting offset is assumed to be 0.
- Tween duration atom (atom type is 'twdu'). This atom specifies how long the interpolation is to last. The time is expressed in the media’s time coordinate system. If this atom is not present, the duration is assumed to be the length of the sample.
- Tween data atom (atom type is 'twdt'). This atom contains the actual values for the interpolation. The contents depend on the value of the tween type atom.
- Tween type atom (atom type is 'twnt'). Describes the type of interpolation to perform.

[Table 3-11](#) (page 154) shows all currently defined tween types. All tween types are currently supported using linear interpolation.

**Table 3-11** Tween type values

Tween type	Value	Tween data
16-bit integer	1	Two 16-bit integers.
32-bit integer	2	Two 32-bit integers.

Tween type	Value	Tween data
32-bit fixed-point	3	Two 32-bit fixed-point numbers.
Point: two 16-bit integers	4	Two points.
Rectangle: four 16-bit integers	5	Two rectangles.
QuickDraw region	6	Two rectangles and a region. The tween entry atom must contain a 'qdrng' atom with an atom ID value of 1. The region is transformed through the resulting matrices.
Matrix	7	Two matrices.
RGB color: three 16-bit integers	8	Two RGB colors.
Graphics mode with RGB color	9	Two graphics modes with RGB color. Only the RGB color is interpolated. The graphics modes must be the same.

Each tween type is distinguished from other types by these characteristics:

- Input values or structures of a particular type
- A particular number of input values or structures (most often one or two)
- Output values or structures of a particular type
- A particular algorithm used to derive the output values

Tween operations for each tween type are performed by a tween component that is specific to that type or, for a number of tween types that are native to QuickTime, by QuickTime itself. Movies and applications that use tweening do not need to specify the tween component to use; QuickTime identifies a tween type by its tween type identifier and automatically routes its data to the correct tween component or to QuickTime.

When a movie contains a tween track, the tween media handler invokes the necessary component (or built-in QuickTime code) for tween operations and delivers the results to another media handler. The receiving media handler can then use the values it receives to modify its playback. For example, the data in a tween track can be used to alter the volume of a sound track.

Tweening can also be used outside of movies by applications or other software that can use the values it generates.

## Tween Type Categories

---

Each of the tween types supported by QuickTime belongs to one of these categories:

- Numeric tween types, which have pairs of numeric values, such as long integers, as input. For these types, linear interpolation is used to generate output values.
- QuickDraw tween types, most of which have pairs of QuickDraw structures, such as points or rectangles, as input. For these types, one or more structure elements are interpolated, such as the *h* and *v* values for points, and each element that is interpolated is interpolated separately from others.

- 3D tween types, which have a QuickDraw 3D structure such as `TQ3Matrix4x4` or `TQ3RotateAboutAxisTransformData` as input. For these types, a specific 3D transformation is performed on the data to generate output.
- The polygon tween type, which takes three four-sided polygons as input. One polygon (such as the bounds for a sprite or track) is transformed, and the two others specify the start and end of the range of polygons into which the tween operation maps it. You can use the output (a `MatrixRecord` data structure) to map the source polygon into any intermediate polygon. The intermediate polygon is interpolated from the start and end polygons for each particular time in the tween duration.
- Path tween types, which have as input a QuickTime vector data stream for a path. Four of the path tween types also have as input a percentage of path's length; for these types, either a point on the path or a data structure is returned. Two other path tween types treat the path as a function: one returns the  $y$  value of the point on the path with a given  $x$  value, and the other returns the  $x$  value of the point on the path with a given  $y$  value.
- The list tween type, which has as input a QT atom container that contains leaf atoms of a specified atom type. For this tween type category, the duration of the tween operation is divided by the number of leaf atoms of the specified type. For time points within the first time division, the data for the first leaf atom is returned; for the second time division, the data for the second leaf atom is returned; and so on. The resulting tween operation proceeds in discrete steps (one step for each leaf atom), instead of the relatively continuous tweening produced by other tween type categories.

## Tween QT Atom Container

---

The characteristics of a tween are specified by the atoms in a tween QT atom container.

A tween QT atom container can contain the atoms described in the following sections.

### General Tween Atoms

---

- `kTweenEntry`

Specifies a tween atom, which can be either a single tween atom, a tween atom in a tween sequence, or an interpolation tween atom.

Its parent is the tween QT atom container (which you specify with the constant `kParentAtomIsContainer`).

The index of a `kTweenEntry` atom specifies when it was added to the QT atom container; the first added has the index 1, the second 2, and so on. The ID of a `kTweenEntry` atom can be any ID that is unique among the `kTweenEntry` atoms contained in the same QuickTime atom container.

This atom is a parent atom. It must contain the following child atoms:

- A `kTweenType` atom that specifies the tween type.
- One or more `kTweenData` atoms that contain the data for the tween atom. Each `kTweenData` atom can contain different data to be processed by the tween component, and a tween component can process data from only one `kTweenData` atom a time. For example, an application can use a list tween to animate sprites. The `kTweenEntry` atom for the tween atom could contain three sets of animation data, one for moving the sprite from left to right, one for moving the sprite from right to left, and one for moving the sprite from top to bottom. In

this case, the `kTweenEntry` atom for the tween atom would contain three `kTweenData` atoms, one for each data set. The application specifies the desired data set by specifying the ID of the `kTweenData` atom to use.

A `kTweenEntry` atom can contain any of the following optional child atoms:

- ❑ A `kTweenStartOffset` atom that specifies a time interval, beginning at the start of the tween media sample, after which the tween operation begins. If this atom is not included, the tween operation begins at the start of the tween media sample.
- ❑ A `kTweenDuration` atom that specifies the duration of the tween operation. If this atom is not included, the duration of the tween operation is the duration of the media sample that contains it.

If a `kTweenEntry` atom specifies a path tween, it can contain the following optional child atom:

- ❑ A `kTweenFlags` atom containing flags that control the tween operation. If this atom is not included, no flags are set.

Note that interpolation tween tracks are tween tracks that modify other tween tracks. The output of an interpolation tween track must be a time value, and the time values generated are used in place of the input time values of the tween track being modified.

If a `kTweenEntry` atom specifies an interpolation tween track, it must contain the following child atoms:

- ❑ A `kTweenInterpolationID` atom for each `kTweenData` atom to be interpolated. The ID of each `kTweenInterpolationID` atom must match the ID of the `kTweenData` atom to be interpolated. The data for a `kTweenInterpolationID` atom specifies a `kTweenEntry` atom that contains the interpolation tween track to use for the `kTweenData` atom.

If this atom specifies an interpolation tween track, it can contain either of the following optional child atoms:

- ❑ A `kTweenOutputMin` atom that specifies the minimum output value of the interpolation tween atom. The value of this atom is used only if there is also a `kTweenOutputMax` atom with the same parent. If this atom is not included and there is a `kTweenOutputMax` atom with the same parent, the tween component uses 0 as the minimum value when scaling output values of the interpolation tween track.
- ❑ A `kTweenOutputMax` atom that specifies the maximum output value of the interpolation tween atom. If this atom is not included, the tween component does not scale the output values of the interpolation tween track.

#### ■ `kTweenStartOffset`

For a tween atom in a tween track of a QuickTime movie, specifies a time offset from the start of the tween media sample to the start of the tween atom. The time units are the units used for the tween track.

Its parent atom is a `kTweenEntry` atom.

A `kTweenEntry` atom can contain only one `kTweenStartOffset` atom. The ID of this atom is always 1. The index of this atom is always 1.

This atom is a leaf atom. The data type of its data is `TimeValue`.

This atom is optional. If it is not included, the tween operation begins at the start of the tween media sample.

- `kTweenDuration`

Specifies the duration of a tween operation. When a QuickTime movie includes a tween track, the time units for the duration are those of the tween track. If a tween component is used outside of a movie, the application using the tween data determines how the duration value and values returned by the component are interpreted.

Its parent atom is a `kTweenEntry` atom.

A `kTweenEntry` atom can contain only one `kTweenDuration` atom. The ID of this atom is always 1. The index of this atom is always 1.

This atom is a leaf atom. The data type of its data is `TimeValue`.

This atom is optional. If it is not included, the duration of the tween operation is the duration of the media sample that contains it.

- `kTweenData`

Contains data for a tween atom.

Its parent atom is a `kTweenEntry` atom.

A `kTweenEntry` atom can contain any number of `kTweenData` atoms.

The index of a `kTweenData` atom specifies when it was added to the `kTweenEntry` atom; the first added has the index 1, the second 2, and so on. The ID of a `kTweenData` atom can be any ID that is unique among the `kTweenData` atoms contained in the same `kTweenEntry` atom.

At least one `kTweenData` atom is required in a `kTweenEntry` atom.

For single tween atoms, a `kTweenData` atom is a leaf atom. It can contain data of any type.

For polygon tween atoms, a `kTweenData` atom is a leaf atom. The data type of its data is `Fixed[27]`, which specifies three polygons.

For path tweens, a `kTweenData` atom is a leaf atom. The data type of its data is `Handle`, which contains a QuickTime vector.

In interpolation tween atoms, a `kTweenData` atom is a leaf atom. It can contain data of any type. An interpolation tween atom can be any tween atoms other than a list tween atom that returns a time value.

In list tween atoms, a `kTweenData` atom is a parent atom that must contain the following child atoms:

- A `kListElementType` atom that specifies the atom type of the elements of the tween atom.
- One or more leaf atoms of the type specified by the `kListElementType` atom. The data for each atom is the result of a list tween operation.

- `kNameAtom`

Specifies the name of a tween atom. The name, which is optional, is not used by tween components, but it can be used by applications or other software.

Its parent atom is a `kTweenEntry` atom.

A `kTweenEntry` atom can contain only one `kNameAtom` atom. The ID of this atom is always 1. The index of this atom is always 1.

This atom is a leaf atom. Its data type is `String`.

This atom is optional. If it is not included, the tween atom does not have a name.

- `kTweenType`

Specifies the tween type (the data type of the data for the tween operation).

Its parent atom is a `kTweenEntry` atom.

A `kTweenEntry` atom can contain only one `kTweenType` atom. The ID of this atom is always 1. The index of this atom is always 1.

This atom is a leaf atom. The data type of its data is `OStype`.

This atom is required.

### Path Tween Atoms

---

- `kTweenFlags`

Contains flags that control the tween operation. One flag that controls path tween atoms is defined:

- The `kTweenReturnDelta` flag applies only to path tween atoms (tweens of type `kTweenTypePathToFixedPoint`, `kTweenTypePathToMatrixTranslation`, `kTweenTypePathToMatrixTranslationAndRotation`, `kTweenTypePathXtoY`, or `kTweenTypePathYtoX`). If the flag is set, the tween component returns the change in value from the last time it was invoked. If the flag is not set, or if the tween component has not previously been invoked, the tween component returns the normal result for the tween atom.

Its parent atom is a `kTweenEntry` atom.

A `kTweenEntry` atom can contain only one `kTweenFlags` atom. The ID of this atom is always 1. The index of this atom is always 1.

This atom is a leaf atom. The data type of its data is `Long`.

This atom is optional. If it is not included, no flags are set.

- `kInitialRotationAtom`

Specifies an initial angle of rotation for a path tween atom of type `kTweenTypePathToMatrixRotation`, `kTweenTypePathToMatrixTranslation`, or `kTweenTypePathToMatrixTranslationAndRotation`.

Its parent atom is a `kTweenEntry` atom.

A `kTweenEntry` atom can contain only one `kInitialRotationAtom` atom. The ID of this atom is always 1. The index of this atom is always 1.

This atom is a leaf atom. Its data type is `Fixed`.

This atom is optional. If it is not included, no initial rotation of the tween atom is performed.

### List Tween Atoms

---

- `kListElementType`

Specifies the atom type of the elements in a list tween atom.

Its parent atom is a `kTweenData` atom.

A `kTweenEntry` atom can contain only one `kListElementType` atom. The ID of this atom is always 1. The index of this atom is always 1.

This atom is a leaf atom. Its data type is QTAtomType.

This atom is required in the kTweenData atom for a list tween atom.

### 3D Tween Atoms

---

#### ■ kTween3dInitialCondition

Specifies an initial transform for a 3D tween atom whose tween type is one of the following: kTweenType3dCameraData, kTweenType3dMatrix, kTweenType3dQuaternion, kTweenType3dRotate, kTweenType3dRotateAboutAxis, kTweenType3dRotateAboutAxis, kTweenType3dRotateAboutPoint, kTweenType3dRotateAboutVector, kTweenType3dScale, or kTweenType3dTranslate.

Its parent atom is a kTweenEntry atom.

A kTweenEntry atom can contain only one kTween3dInitialCondition atom. The ID of this atom is always 1. The index of this atom is always 1.

This atom is a leaf atom. The data type of its data is as follows:

- For a kTweenType3dCameraData tween, its data type is TQ3CameraData.
- For a kTweenType3dMatrix tween, its data type is TQ3Matrix4x4.
- For a kTweenType3dQuaternion tween, its data type is TQ3Quaternion.
- For a kTweenType3dRotate tween, its data type is TQ3RotateTransformData.
- For a kTweenType3dRotateAboutAxis tween, its data type is TQ3RotateAboutAxisTransformData.
- For a kTweenType3dRotateAboutPoint tween, its data type is TQ3RotateAboutPointTransformData.
- For a kTweenType3dRotateAboutVector tween, its data type is TQ3PlaneEquation.
- For a kTweenType3dScale tween, its data type is TQ3Vector3D.
- For a kTweenType3dTranslate tween, its data type is TQ3Vector3D.

This atom is optional. For each tween type, the default value is the data structure that specifies an identity transform, that is, a transform that does not alter the 3D data.

### Interpolation Tween Atoms

---

#### ■ kTweenOutputMax

Specifies the maximum output value of an interpolation tween atom. If a kTweenOutputMax atom is included for an interpolation tween, output values for the tween atom are scaled to be within the minimum and maximum values. The minimum value is either the value of the kTweenOutputMin atom or, if there is no kTweenOutputMin atom, 0. For example, if an interpolation tween atom has values between 0 and 4, and it has kTweenOutputMin and kTweenOutputMax atoms with values 1 and 2, respectively, a value of 0 (the minimum value before scaling) is scaled to 1 (the minimum specified by the kTweenOutputMin atom), a value of 4 (the maximum value before scaling) is scaled to 2 (the maximum specified by the kTweenOutputMax atom), and a value of 3 (three-quarters of the way between the maximum and minimum values before scaling) is scaled to 1.75 (three-quarters of the way between the values of the kTweenOutputMin and kTweenOutputMax atoms).



Its parent atom is a `kTweenEntry` atom.

A `kTweenEntry` atom can contain only one `kTweenOutputMax` atom. The ID of this atom is always 1. The index of this atom is always 1.

This atom is a leaf atom. The data type of its data is `Fixed`.

This atom is optional. If it is not included, QuickTime does not scale interpolation tween values.

- `kTweenOutputMin`

Specifies the minimum output value of an interpolation tween atom. If both `kTweenOutputMin` and `kTweenOutputMax` atoms are included for an interpolation tween atom, output values for the tween atom are scaled to be within the minimum and maximum values. For example, if an interpolation tween atom has values between 0 and 4, and it has `kTweenOutputMin` and `kTweenOutputMax` atoms with values 1 and 2, respectively, a value of 0 (the minimum value before scaling) is scaled to 1 (the minimum specified by the `kTweenOutputMin` atom), a value of 4 (the maximum value before scaling) is scaled to 2 (the maximum specified by the `kTweenOutputMax` atom), and a value of 3 (three-quarters of the way between the maximum and minimum values before scaling) is scaled to 1.75 (three-quarters of the way between the values of the `kTweenOutputMin` and `kTweenOutputMax` atoms).

If a `kTweenOutputMin` atom is included but a `kTweenOutputMax` atom is not, QuickTime does not scale interpolation tween values.

Its parent atom is a `kTweenEntry` atom.

A `kTweenEntry` atom can contain only one `kTweenOutputMin` atom. The ID of this atom is always 1. The index of this atom is always 1.

This atom is a leaf atom. The data type of its data is `Fixed`.

This atom is optional. If it is not included but a `kTweenOutputMax` atom is, the tween component uses 0 as the minimum value for scaling values of an interpolation tween atom.

- `kTweenInterpolationID`

Specifies an interpolation tween atom to use for a specified `kTweenData` atom. There can be any number of `kTweenInterpolationID` atoms for a tween atom, one for each `kTweenData` atom to be interpolated.

Its parent atom is a `kTweenEntry` atom.

The index of a `kTweenInterpolationID` atom specifies when it was added to the `kTweenEntry` atom; the first added has the index 1, the second 2, and so on. The ID of a `kTweenInterpolationID` atom must match the atom ID of the `kTweenData` atom to be interpolated, and be unique among the `kTweenInterpolationID` atoms contained in the same `kTweenEntry` atom.

This atom is a leaf atom. The data type of its data is `QTAtomID`.

This atom is required for an interpolation tween atom.

## Region Tween Atoms

---

- `kTweenPictureData`

Contains the data for a QuickDraw picture. Used only by a `kTweenTypeQDRegion` atom.

Its parent atom is a `kTweenEntry` atom.

A `kTweenEntry` atom can contain only one `kTweenPictureData` or `kTweenRegionData` atom. The ID of this atom is always 1. The index of this atom is always 1.

This atom is a leaf atom. The data type of its data is `Picture`.

Either a `kTweenPictureData` or `kTweenRegionData` atom is required for a `kTweenTypeQDRegion` atom.

- `kTweenRegionData`

Contains the data for a QuickDraw region. Used only by a `kTweenTypeQDRegion` atom.

Its parent atom is a `kTweenEntry` atom.

A `kTweenEntry` atom can contain only one `kTweenRegionData` or `kTweenPictureData` atom. The ID of this atom is always 1. The index of this atom is always 1.

This atom is a leaf atom. The data type of its data is `Region`.

Either a `kTweenPictureData` or `kTweenRegionData` atom is required for a `kTweenTypeQDRegion` tween.

### Sequence Tween Atoms

---

- `kTweenSequenceElement`

Specifies an entry in a tween sequence.

Its parent is the tween QT atom container (which you specify with the constant `kParentAtomIsContainer`).

The ID of a `kTweenSequenceElement` atom must be unique among the `kTweenSequenceElement` atoms in the same QT atom container. The index of a `kTweenSequenceElement` atom specifies its order in the sequence; the first entry in the sequence has the index 1, the second 2, and so on.

This atom is a leaf atom. The data type of its data is `TweenSequenceEntryRecord`, a data structure that contains the following fields:

`endPercent`

A value of type `Fixed` that specifies the point in the duration of the tween media sample at which the sequence entry ends. This is expressed as a percentage; for example, if the value is 75.0, the sequence entry ends after three-quarters of the total duration of the tween media sample have elapsed. The sequence entry begins after the end of the previous sequence entry or, for the first entry in the sequence, at the beginning of the tween media sample.

`tweenAtomID`

A value of type `QTAtomID` that specifies the `kTweenEntry` atom containing the tween for the sequence element. The `kTweenEntry` atom and the `kTweenSequenceElement` atom must both be a child atoms of the same tween QT atom container.

`dataAtomID`

A value of type `QTAtomID` that specifies the `kTweenData` atom containing the data for the tween. This atom must be a child atom of the atom specified by the `tweenAtomID` field.

## Modifier Tracks

---

The addition of modifier tracks in QuickTime 2.1 introduced the capability for creating dynamic movies. (A modifier track sends data to another track; by comparison, a track reference is an association.) For example, instead of playing video in a normal way, a video track could send its image data to a sprite track. The sprite track then could use that video data to replace the image of one of its sprites. When the movie is played, the video track appears as a sprite.

Modifier tracks are not a new type of track. Instead, they are a new way of using the data in existing tracks. A modifier track does not present its data, but sends it to another track that uses the data to modify how it presents its own data. Any track can be either a sender or a presenter, but not both. Previously, all tracks were presenters.

Another use of modifier tracks is to store a series of sound volume levels, which is what occurs when you work with a tween track. These sound levels can be sent to a sound track as it plays to dynamically adjust the volume. A similar use of modifier tracks is to store location and size information. This data can be sent to a video track to cause it to move and resize as it plays.

Because a modifier track can send its data to more than one track, you can easily synchronize actions between multiple tracks. For example, a single modifier track containing matrices as its samples can make two separate video tracks follow the same path.

See [“Creating Movies With Modifier Tracks”](#) (page 238) for more information about using modifier tracks.

## Limitations of Spatial Modifier Tracks

---

A modifier track may cause a track to move outside of its original boundary regions. This may present problems, since applications do not expect the dimensions or location of a QuickTime movie to change over time.

To ensure that a movie maintains a constant location and size, the Movie Toolbox limits the area in which a spatially modified track can be displayed. A movie’s “natural” shape is defined by the region returned by the `GetMovieBoundsRgn` function. The toolbox clips all spatially modified tracks against the region returned by `GetMovieBoundsRgn`. This means that a track can move outside of its initial boundary regions, but it cannot move beyond the combined initial boundary regions of all tracks in the movie. Areas uncovered by a moving track are handled by the toolbox in the same way as areas uncovered by tracks with empty edits.

If a track has to move through a larger area than that defined by the movie’s boundary region, the movie’s boundary region can be enlarged to any desired size by creating a spatial track (such as a video track) of the desired size but with no data. As long as the track is enabled, it contributes to the boundary regions of the movie.

## Track References

---

Although QuickTime has always allowed the creation of movies that contain more than one track, it has not been able to specify relationships between those tracks. Track references are a feature of QuickTime that allows you to relate a movie's tracks to one another. The QuickTime track-reference mechanism supports many-to-many relationships. That is, any movie track may contain one or more track references, and any track may be related to one or more other tracks in the movie.

Track references can be useful in a variety of ways. For example, track references can be used to relate timecode tracks to other movie tracks. You can use track references to identify relationships between video and sound tracks—identifying the track that contains dialog and the track that contains background sounds, for example. Another use of track references is to associate one or more text tracks that contain subtitles with the appropriate audio track or tracks.

Track references are also used to create chapter lists, as described in the next section.

Every movie track contains a list of its track references. Each track reference identifies another related track. That related track is identified by its track identifier. The track reference itself contains information that allows you to classify the references by type. This type information is stored in an OSType data type. You are free to specify any type value you want. Note, however, that Apple has reserved all lowercase type values.

You may create as many track references as you want, and you may create more than one reference of a given type. Each track reference of a given type is assigned an index value. The index values start at 1 for each different reference type. The Movie Toolbox maintains these index values, so that they always start at 1 and count by 1.

Using the `AddTrackReference` function, you can relate one track to another. The `DeleteTrackReference` function will remove that relationship. The `SetTrackReference` and `GetTrackReference` functions allow you to modify an existing track reference so that it identifies a different track. The `GetNextTrackReferenceType` and `GetTrackReferenceCount` functions allow you to scan all of a track's track references.

## Chapter Lists

---

A chapter list provides a set of named entry points into a movie, allowing the user to jump to a preselected point in the movie from a convenient pop-up list.

The movie controller automatically recognizes a chapter list and will create a pop-up list from it. When the user makes a selection from the pop-up, the controller will jump to the appropriate point in the movie. Note that if the movie is sized so that the controller is too narrow to display the chapter names, the pop-up list will not appear.

To create a chapter list, you must create a text track with one sample for each chapter. The display time for each sample corresponds to the point in the movie that marks the beginning of that chapter. You must also create a track reference of type 'chap' from an enabled track of the movie to the text track. It is the 'chap' track reference that makes the text track into a chapter list. The track containing the reference can be of any type (audio, video, MPEG, and so on), but it must be enabled for the chapter list to be recognized.

Given an enabled track `myVideoTrack`, for example, you can use the `AddTrackReference` function to create the chapter reference:

```
AddTrackReference( myVideoTrack, theTextTrack,
                   kTrackReferenceChapterList,
                   &addedIndex );
```

`kTrackReferenceChapterList` is defined in `Movies.h`. It has the value `'chap'`.

The text track that constitutes the chapter list does not need to be enabled, and normally is not. If it is enabled, the text track will be displayed as part of the movie, just like any other text track, in addition to functioning as a chapter list.

If more than one enabled track includes a `'chap'` track reference, QuickTime uses the first chapter list that it finds.

## 3D Media

---

QuickTime movies store 3D image data in a base media. This media has a media type of `'qd3d'`.

### 3D Sample Description

---

The 3D sample description uses the standard sample description header, as described in [“Sample Table Atoms”](#) (page 76).

The data format field in the sample description is always set to `'qd3d'`. The 3D media handler adds no additional fields to the sample description.

### 3D Sample Data

---

The 3D samples are stored in the 3D Metafile format developed for QuickDraw 3D.

## Streaming Media

---

QuickTime movies store streaming data in a streaming media track. This media has a media type of `'strm'`.

### Streaming Media Sample Description

---

The streaming media sample description contains information that defines how to interpret streaming media data. This sample description is based on the standard sample description header, as described in [“Sample Table Atoms”](#) (page 76).

The streaming media sample description is documented in the QuickTime header file `QTSMovie.h`, as shown in [Listing 3-1](#) (page 166).

**Listing 3-1** Streaming media sample description

```
struct QTSSampleDescription {
    long          descSize;
    long          dataFormat;
    long          resvd1;    /* set to 0*/
    short         resvd2;    /* set to 0*/
    short         dataRefIndex;
    UInt32        version;
    UInt32        resvd3;    /* set to 0*/
    SInt32        flags;
                    /* qt atoms follow:*/
                    /* long size, long type, some data*/
                    /* repeat as necessary*/
};
typedef struct QTSSampleDescription    QTSSampleDescription;
```

The sample format depends on the `dataFormat` field of the `QTSSampleDescription`. The `dataFormat` field can be any value you specify. The currently defined values are `'rtsp'` and `'sdp'`.

If `'rtsp'`, the sample can be just an rtsp URL. It can also be any value that you can put in a `.rtsp` file, as defined at

<http://streaming.apple.com/qtstreaming/documentation/userdocs/rtsptags.htm>

If `'sdp'`, then the sample is an SDP file. This would be used to receive a multicast broadcast.

## Hint Media

---

The QuickTime file format supports streaming of media data over a network as well as local playback. The process of sending protocol data units is time-based, just like the display of time-based data, and is therefore suitably described by a time-based format. A QuickTime file or movie that supports streaming includes information about the data units to stream. This information is included in additional tracks of the movie called hint tracks.

Hint tracks contain instructions for a streaming server which assist in the formation of packets. These instructions may contain immediate data for the server to send (for example, header information) or reference segments of the media data. These instructions are encoded in the QuickTime file in the same way that editing or presentation information is encoded in a QuickTime file for local playback.

Instead of editing or presentation information, information is provided which allows a server to packetize the media data in a manner suitable for streaming, using a specific network transport.

The same media data is used in a QuickTime file which contains hints, whether it is for local playback, or streaming over a number of different transport types. Separate hint tracks for different transport types may be included within the same file and the media will play over all such transport types without making any additional copies of the media itself. In addition, existing media can be easily made streamable by the addition of appropriate hint tracks for specific transports. The media data itself need not be recast or reformatted in any way.

Typically, hinting is performed by media packetizer components. QuickTime selects an appropriate media packetizer for each track and routes each packetizer's output through an Apple-provided packet builder to create a hint track. One hint track is created for each streamable track in the movie.

Hint tracks are quite small compared with audio or video tracks. A movie that contains hint tracks can be played from a local disk or streamed over HTTP, similar to any other QuickTime movie. Hint tracks are only used when streaming a movie over a real-time media streaming protocol, such as RTP.

Support for streaming in the QuickTime file format is based upon the following considerations:

- Media data represented as a set of network-independent standard QuickTime tracks, which may be played or edited, as normal.
- A common declaration and base structure for server hint tracks; this common format is protocol independent, but contains the declarations of which protocols are described in the server tracks.
- A specific design of the server hint tracks for each protocol which may be transmitted; all these designs use the same basic structure.

The resulting streams, sent by the servers under the direction of hint tracks, do not need to contain any trace of QuickTime information. This approach does not require that QuickTime, or its structures or declaration style, be used either in the data on the wire or in the decoding station. For example, a QuickTime file using H.261 video and DVI audio, streamed under Real-Time Protocol (RTP), results in a packet stream which is fully compliant with the IETF specifications for packing those codings into RTP.

Hint tracks are built and flagged, so that when the movie is viewed directly (not streamed), they are ignored.

The next section describes a generic format for streaming hints to be stored in a QuickTime movie.

## Adding Hint Tracks to a Movie

---

To store packetization hints, one or more hint tracks are added to a movie. Each hint track contains hints for at least one actual media track to be streamed. A streamed media track may have more than one hint track. For example, it might have a separate hint track for the different packet sizes the server supports, or it might have different hint tracks for different protocols. It is not required that all media tracks have corresponding hint tracks in a movie.

The sample time of a hint sample corresponds to the sample time of the media contained in the packets generated by that hint sample. The hint sample may also contain a transmission time for each packet. (The format for the hint sample is specific to the hint track type.)

The hint track may have a different time scale than its referenced media tracks.

The `flags` field in the track header atom ('`tkhd`') must be set to `0x000000`, indicating that the track is inactive and is not part of the movie, preview, or poster.

The `subType` field of the handler description atom ('`hdlr`') contains '`hint`', indicating that the media type is packetization hints.

Note that if a QuickTime media track is edited, any previously stored packetization hints may become invalid. Comparing the modification dates of the media track and the hint track is one way to determine this scenario, but it is far from being foolproof. Since the hint track keeps track of which original track

media samples and sample descriptions to play at specific times, changes that affect those parts of the original track or media make those hints invalid. Changes to a movie that do not invalidate existing hint tracks include flattening (when there are no edit lists), and adding new tracks. Changes that invalidate hint tracks include:

- Flattening (when there are edit lists)
- Adding or deleting samples
- Changing a track's time scale
- Changing sample descriptions



**Warning:** Hint tracks are marked as inactive, so calling the `FlattenMovie` function with the `flattenActiveTracksOnly` bit set deletes all hint tracks from a movie.

## Packetization Hint Media Header Atom

---

In QuickTime movies, the media information atom ('`minf`') contains header data specific to the media. For hint tracks, the media header is a base media information atom ('`gmhd`'). The hint track must contain the base media information atom.

## Hint Track User Data Atom

---

Each hint track may contain track user data atoms that apply to only to the corresponding hint track. There are currently two such atoms defined.

- User data atom type '`hinf`'.

This contains statistics for the hint track. The '`hinf`' atom contains child atoms as defined in [Table 3-12](#) (page 169). In some cases, there are both 32-bit and 64-bit counters available. Any unknown types should be ignored.

- User data atom type '`hnti`'.

This may contain child atoms. Child atoms that start with ' `sdp` ' (note, again, the space) contain SDP text for this track. Text from these child atoms must be inserted into the proper place in the SDP text for the movie, after any common SDP text. This is analogous to the movie-level '`hnti`' atom.

## Movie Hint Info Atom

---

A movie may contain an '`hnti`' movie user data atom, which may contain one or more child atoms. The child atom contents start with 4 bytes that specify the transport and 4 bytes that specify the type of data contained in the rest of the child atom. Currently, the only defined transport is ' `rtp` ' (note the space) and the only content data type defined is ' `sdp` ' (note the space). Child atoms whose transport or type combinations you don't recognize should be skipped.



The text in an atom of type 'rtsp sdp' should be inserted (in the proper place) into the SDP information generated from this file (for example, by a streaming server) before any SDP information for specific tracks.

Table 3-12 (page 169) describes the type and values of the 'hnti' atom.

**Table 3-12** The 'hinf' atom type containing child atoms

Type	Value	Description
'trpY'	8 bytes	The total number of bytes that will be sent, including 12-byte RTP headers, but not including any network headers.
'totl'	4 bytes	4-byte version of 'trpY'
'numP'	8 bytes	The total number of network packets that will be sent (if the application knows there is a 28-byte network header, it can multiply 28 by this number and add it to the 'trpY' value to get the true number of bytes sent).
'npck'	4 bytes	4-byte version of 'numP'
'tpyl'	8 bytes	The total number of bytes that will be sent, not including 12-byte RTP headers.
'tpaY'	4 bytes	4-byte version of 'tpyl'
'maxr'	8 bytes	The maximum data rate. This atom contains two numbers: g, followed by m (both 32-bit values). g is the granularity, in milliseconds. m is the maximum data rate given that granularity. For example, if g is 1 second, then m is the maximum data rate over any 1 second. There may be multiple 'maxr' atoms, with different values for g. The maximum data rate calculation does not include any network headers (but does include 12-byte RTP headers).
'dmed'	8 bytes	The number of bytes from the media track to be sent.
'dimm'	8 bytes	The number of bytes of immediate data to be sent.
'drep'	8 bytes	The number of bytes of repeated data to be sent.
'tmin'	4 bytes	The smallest relative transmission time, in milliseconds.
'tmax'	4 bytes	The largest relative transmission time, in milliseconds.
'pmax'	4 bytes	The largest packet, in bytes; includes 12-byte RTP header.
'dmax'	4 bytes	The largest packet duration, in milliseconds.
'payt'	Variable	The payload type, which includes payload number (32-bits) followed by rtpmap payload string (Pascal string).

**Note:** Any of the atoms shown in [Table 3-12](#) (page 169) may or may not be present. These atoms are not guaranteed.

## Finding an Original Media Track From a Hint Track

---

Like any other QuickTime track, hint tracks can contain track reference atoms. Exactly one of these must be of track reference type 'hint', and its internal list must contain at least one track ID, which is the track ID of the original media track. Like other track reference atoms, there may be empty references in this list, indicated by a track ID of 0. For hint tracks that refer to more than one track, the index number (starting at 1, and including any 0 entries) is used in the media track reference index field in some of the packet data table entry modes.

For example, if you have MPEG-1 video at track ID 11 and MPEG-1 layer 2 audio at track ID 12, and you are creating a RTP hint track that encapsulates these in an MPEG-2 transport, you need to refer to both tracks. You can also assume that there are some empty entries and other track references in your hint track atom reference atom's list. So it might look like this: 11, 0, 0, 14, 0, 12, 0. When you are assembling packets from audio and video tracks 11 and 12, you use their list indexes (1 and 6) in the media track ref index field.

If you have only one media track listed in your hint track reference, you may simply use a 0 in the media track ref index field.

## RTP Hint Tracks

---

RTP hint tracks contain information that allows a streaming server to create RTP streams from a QuickTime movie, without requiring the server to know anything about the media type, compression, or payload format.

In RTP, each media stream, such as an audio or video track, is sent as a separate RTP stream. Consequently, each media track in the movie has an associated RTP hint track containing the data necessary to packetize it for RTP transport, and each hint track contains a track reference back to its associated media track.

Media tracks that do not have an associated RTP hint track cannot be streamed over RTP and should be ignored by RTP streaming servers.

It is possible for a media track to have more than one associated hint track. The hint track contains information such as the packet size and time scale in the hint track's sample description. This minimizes the runtime server load, but in order to support multiple packet sizes it is necessary to have multiple RTP hint tracks for each media track, each with different a packet size. A similar mechanism could be used to provide hint tracks for multiple protocols in the future.

It is also possible for a single hint track to refer to more than one media stream. For example, audio and video MPEG elementary streams could be multiplexed into a single systems stream RTP payload format, and a single hint track would contain the necessary information to combine both elementary streams into a single series of RTP packets.

This is the exception rather than the rule, however. In general, multiplexing is achieved by using IP's port-level multiplexing, not by interleaving the data from multiple streams into a single RTP session.

The hint track is related to each base media track by a track reference declaration. The sample description for RTP declares the maximum packet size that this hint track will generate. Partial session description (SDP) information is stored in the track's user data atom.

## Hint Sample Data Format

---

The sample description atom ('stsd') contains information about the hint track samples. It specifies the data format (note that currently only RTP data format is defined) and the data reference to use (if more than one is defined) to locate the hint track sample data. It also contains some general information about this hint track, such as the hint track version number, the maximum packet size allowed by this hint track, and the RTP time scale. It may contain additional information, such as the random offsets to add to the RTP time stamp and sequence number.

The sample description atom can contain a table of sample descriptions to accommodate media that are encoded in multiple formats, but a hint track can be expected to have a single sample description at this time.

The sample description for hint tracks is defined in [Table 3-13](#) (page 171).

**Table 3-13** Hint track sample description

Field	Bytes
Size	4
Data format	4
Reserved	6
Data reference index	2
Hint track version	2
Last compatible hint track version	2
Max packet size	4
Additional data table	variable

### Field descriptions

#### Size

A 32-bit integer specifying the size of this sample description in bytes.

#### Data format

A four-character code indicating the data format of the hint track samples. Only 'rtp ' is currently defined. Note that the fourth character in 'rtp ' is an ASCII blank space (0x20). Do not attempt to packetize data whose format you do not recognize.

**Reserved**

Six bytes that must be set to 0.

**Data reference index**

This field indirectly specifies where to find the hint track sample data. The data reference is a file or resource specified by the data reference atom ('dref') inside the data information atom ('dinf') of the hint track. The data information atom can contain a table of data references, and the data reference index is a 16-bit integer that tells you which entry in that table should be used. Normally, the hint track has a single data reference, and this index entry is set to 0.

**Hint track version**

A 16-bit unsigned integer indicating the version of the hint track specification. This is currently set to 1.

**Last compatible hint track version**

A 16-bit unsigned integer indicating the oldest hint track version with which this hint track is backward-compatible. If your application understands the hint track version specified by this field, it can work with this hint track.

**Max packet size**

A 32-bit integer indicating the packet size limit, in bytes, used when creating this hint track. The largest packet generated by this hint track will be no larger than this limit.

**Additional data table**

A table of variable length containing additional information. Additional information is formatted as a series of tagged entries.

This field always contains a tagged entry indicating the RTP time scale for RTP data. All other tagged entries are optional.

Three data tags are currently defined for RTP data. One tag is defined for use with any type of data. You can create additional tags. Tags are identified using four-character codes. Tags using all lowercase letters are reserved by Apple. Ignore any tagged data you do not understand.

Table entries are structured like atoms. The structure of table entries is shown in [Table 3-14](#) (page 172).

**Table 3-14** The structure of table entries

Field	Format	Bytes
Entry length	32-bit integer	4
Data tag	4-char code	4
Data	Variable	Entry length - 8

Tagged entries for the 'rtp' data format are defined as follows:

'tims'

A 32-bit integer specifying the RTP time scale. This entry is required for RTP data.

'tsro'

A 32-bit integer specifying the offset to add to the stored time stamp when sending RTP packets. If this entry is not present, a random offset should be used, as specified by the IETF. If this entry is 0, use an offset of 0 (no offset).

'snro'

A 32-bit integer specifying the offset to add to the sequence number when sending RTP packets. If this entry is not present, a random offset should be used, as specified by the IETF. If this entry is 0, use an offset of 0 (no offset).

## Packetization Hint Sample Data for Data Format 'rtp'

---

This section describes the sample data for the 'rtp' format. The 'rtp' format assumes that the server is sending data using Real-Time Transport Protocol (RTP). This format also assumes that the server “knows” about RTP headers but does not require that the server know anything about specific media headers, including media headers defined in various IETF drafts.

Each sample in the hint track will generate one or more RTP packets. Each entry in the sample data table in a hint track sample corresponds to a single RTP packet. Samples in the hint track may or may not correspond exactly to samples in the media track. Data in the hint track sample is byte aligned, but not 32-bit aligned.

The RTP timestamps of all packets in a hint sample are the same as the hint sample time. In other words, packets that do not have the same RTP timestamp cannot be placed in the same hint sample.

The RTP hint track time scale should be reasonably chosen so that there is adequate spacing between samples (as well as adequate spacing between transmission times for packets within a sample).

The packetization hint sample data contains the following data elements.

Packetization hint sample data	Bytes
Entry count	2
Reserved	2
Packet entry table	Variable
Additional data	Variable

### Field descriptions

#### Entry count

A 16-bit unsigned integer indicating the number of packet entries in the table. Each entry in the table corresponds to a packet. Multiple entries in a single sample indicate that the media sample had to be split into multiple packets. A sample with an entry count of 0 is reserved and, if encountered, must be skipped.

#### Reserved

Two bytes that must be set to 0.

#### Packet entry table

A variable length table containing packet entries. Packet entries are defined below.

#### Additional data

A variable length field containing data pointed to by the entries in the data table.

The packet entry contains the following data elements.

Packet entry	Bytes
Relative packet transmission time	4
RTP header info	2
RTP sequence number	2
Flags	2
Entry count	2
Extra information TLVs	0 or variable
Data table	variable

Relative packet transmission time

A 32-bit signed integer value, indicating the time, in the hint track’s time scale, to send this packet relative to the hint sample’s actual time. Negative values mean that the packet will be sent earlier than real time, which is useful for smoothing the data rate. Positive values are useful for repeating packets at later times. Within each hint sample track, each packet time stamp must be non-decreasing.

RTP header info

A 16-bit integer specifying various values to be set in the RTP header. The bits of the field are defined as follows.

0	1	2	3	4	5	6	7	8	9	0	1	2	3	4	5
reserved	P	X	reserved					M	payload type						

The RTP header information field contains the following elements.

Field	Bit#	Description
P	2	A 1-bit number corresponding to the padding (P) bit in the RTP header. This bit should probably not be set, since a server that needs different packet padding would need to unpad and repad the packet itself.
X	3	A 1-bit number corresponding to the extension (X) bit in the RTP header. This bit should probably not be set, since a server that needs to send its own RTP extension would either not be able to, or would be forced to replace any extensions from the hint track.
M	8	A 1-bit number corresponding to the marker (M) bit in the RTP header.
Payload type	9-15	A 7-bit number corresponding to the payload type (PT) field of the RTP header.

All undefined bits are reserved and must be set to zero. Note that the location of the defined bits are in the same bit location as in the RTP header.

RTP sequence number

A 16-bit integer specifying the RTP sequence number for this packet. The RTP server adds a random offset to this sequence number before transmitting the packet. This field allows re-transmission of packets—for example, the same packet can be assembled with the same sequence number and a different (later) packet transmission time. A text sample with a duration of 5 minutes can be retransmitted every 10 seconds, so that clients that miss the original sample transmission (perhaps they started playing the movie in the middle) will be refreshed after a maximum of 10 seconds.

Flags

A 16-bit field indicating certain attributes for this packet. Defined bits are:

0	1	...	...	12	13	14	15
reserved				X	B	R	

The RTP header information field contains the following elements.

Field	Bit#	Description
X	13	A 1-bit number indicating that this packet contains an Extra information TLV data table.
B	14	A 1-bit number indicating that this packet contains data that is part of a b-frame. A server that is having difficulty being able to send all the packets in real time may discard packets that have this bit set, until it catches up with the clock.
R	15	A 1-bit number indicating that this is a repeat packet: the data has been defined in a previous packet. A server may choose to skip repeat packets to help it catch up when it is behind in its transmission of packets. All repeated packets for a given packet must live in the same hint sample.

All undefined bits are reserved and must be set to 0.

Entry count

A 16-bit unsigned integer specifying the number of entries in the data table.

Extra information TLVs

The extra information TLVs are only present if and only if the X bit is set in the flags field above. This provides a way of extending the hint track format without changing the version, while allowing backward compatibility.

Extra information TLVs	Bytes
Extra information size	4
TLV size	4
TLV type	4
TLV data	Padded to 4-byte boundary( $\text{int}(\text{TLV Size} - 8 + 3) / 4 * 4$ )
TLV size	4

Extra information TLVs	Bytes
TLV type	4
TLV data	Padded to 4-byte boundary( $\text{int}(\text{TLV Size} - 8 + 3) / 4 * 4$ )
TLV size and so forth	...

**Extra information size**

A 32-bit number that is the total size of all extra information TLVs in this packet, including the 4 bytes used for this field. An empty Extra information TLVs table would just be the extra information size, having the value 4. (In this case, it would be more efficient simply to not set the X bit and save 4 bytes just to represent the empty table.)

**TLV size**

A 32-bit number that is the total size of this one TLV entry, including 4 bytes for the size, 4 bytes for the type, and any data bytes, but not including padding required to align to the next 4 byte boundary.

**TLV type**

A 32-bit tag (a four-character OStype) identifying the TLV. Servers must ignore TLV types that they do not recognize. Note that TLV types containing all lowercase letters are reserved by Apple Computer.

**TLV data**

The data for the TLV.

In order to support MPEG (and other data types) whose RTP timestamp is not monotonically increasing and directly calculated from the sample timestamp, the following TLV type is defined:

Size	Type	Data Description
12	'rtpo'	A signed 32-bit integer to be added to the RTP timestamp, which is derived from the hint sample timestamp.

**Data table**

A table that defines the data to be put in the payload portion of the RTP packet. This table defines various places the data can be retrieved.

Data table entry	Bytes
Data source	1
Data	15

The data source field of the entry table indicates how the other 15 bytes of the entry are to be interpreted. Values of 0 through 4 are defined. The various data table formats are defined below.

Although there are various schemes, note that the entries in the various schemes are the same size, 16 bytes long.



## No-Op Data Mode

---

The data table entry has the following format for no-op mode:

0	1	2	3	4	5	6	7	8	9	0	1	2	3	4	5
data source = 0								ignored							
ignored															

### Field descriptions

Data source = 0

A value of 0 indicates that this data table entry is to be ignored.

## Immediate Data Mode

---

The data table entry has the following format for immediate mode:

0	1	2	3	4	5	6	7	8	9	0	1	2	3	4	5
data source = 1								immediate length							
immediate data															

### Field descriptions

Data source = 1

A value of 1 indicates that the data is to be immediately taken from the bytes of data that follow.

Immediate length

An 8-bit integer indicating the number of bytes to take from the data that follows. Legal values range from 0 to 14.

Immediate data

14 bytes of data to place into the payload portion of the packet. Only the first number of bytes indicated by the immediate length field is used.

## Sample Mode

---

The data table entry has the following format for sample mode.

0	1	2	3	4	5	6	7	8	9	0	1	2	3	4	5
data source = 2									track ref index						
length															
sample number															
offset															
bytes per compression block															
samples per compression block															

**Field descriptions**

**Data source = 2**

A value of 2 indicates that the data is to be taken from a track’s sample data.

**Track ref index**

A value that indicates which track the sample data will come from. A value of 0 means that there is exactly one media track referenced, so use that. Values from 1 to 127 are indexes into the hint track reference atom entries, indicating which original media track the sample is to be read from. A value of -1 means the hint track itself, that is, get the sample from the same track as the hint sample you are currently parsing.

**Length**

A 16-bit integer specifying the number of bytes in the sample to copy.

**Sample number**

A 32-bit integer specifying sample number of the track.

**Offset**

A 32-bit integer specifying the offset from the start of the sample from which to start copying. If you are referencing samples in the hint track, this will generally points into the Additional Data area.

**Bytes per compression block**

A 16-bit unsigned integer specifying the number of bytes that results from compressing the number of samples in the Samples per compression block field. A value of 0 is equivalent to a value of 1.

**Samples per compression block**

A 16-bit unsigned integer specifying the uncompressed samples per compression block. A value of 0 is equivalent to a value of 1.

If the bytes per compression block and/or the samples per compression block is greater than 1, than this ratio is used to translate a sample number into an actual byte offset.

This ratio mode is typically used for compressed audio tracks. Note that for QuickTime sound tracks, the bytes per compression block also factors in the number of sound channels in that stream, so a QuickTime stereo sound stream’s BPCB would be twice that of a mono stream of the same sound format.

$$(CB = NS * BPCB / SPCB)$$

where CB = compressed bytes, NS = number of samples, BPCB = bytes per compression block, and SPCB = samples per compression block.

An example:

A GSM compression block is typically 160 samples packed into 33 bytes.

So, BPCB = 33 and SPCB = 160.

The hint sample requests 33 bytes of data starting at the 161st media sample. Assume that the first QuickTime chunk contains at least 320 samples. So after determining that this data will come from chunk 1, and knowing where chunk 1 starts, you must use this ratio to adjust the offset into the file where the requested samples will be found:

```
chunk_number = 1; /* calculated by walking the sample-to-chunk atom */
first_sample_in_this_chunk = 1; /* also calculated from that atom */
chunk_offset = chunk_offsets[chunk_number]; /* from the stco atom */
data_offset = (sample_number - first_sample_in_this_chunk) * BPCB / SPCB;
read_from_file(chunk_offset + data_offset, length); /* read our data */
```

## Sample Description Mode

---

The data table entry has the following format for sample description mode:

0	1	2	3	4	5	6	7	8	9	0	1	2	3	4	5
data source = 3						track ref index									
length															
sample description index															
offset															
reserved															

### Field descriptions

#### Data source = 3

A value of 3 indicates that the data is to be taken from the media track's sample description table.

#### Track ref index

A value that indicates which track the sample description will come from. A value of 0 means that there is exactly one hint track reference, so use that. Values from 1 to 127 are indexes into the hint track reference atom entries, indicating which original media track the sample is to be read from. A value of -1 means the hint track itself, that is, get the sample description from the same track as the hint sample you are currently parsing.

#### Length

A 16-bit integer specifying the number of bytes to copy.

**Sample description index**

A 32-bit integer specifying the index into the media's sample description table.

**Offset**

A 32-bit integer specifying the offset from the start of the sample description from which to start copying.

**Reserved**

Four bytes that must be set to 0.

**Additional data**

A variable length field containing data pointed to by hint track sample mode entries in the data table.

## VR Media

---

This section describes the QuickTime VR world and node information atom containers, which can be obtained by calling the QuickTime VR Manager routines `QTVRGetVRWorld` and `QTVRGetNodeInfo`. Those routines, as well as a complete discussion of QuickTime VR and how your application can create QuickTime VR movies, are described in detail in *QuickTime VR*.

Many atom types contained in the VR world and node information atom containers are unique within their container. For example, each has a single header atom. Most parent atoms within an atom container are unique as well, such as the node parent atom in the VR world atom container or the hot spot parent atom in the node information atom container. For these one-time-only atoms, the atom ID is always set to 1. Unless otherwise mentioned in the descriptions of the atoms that follow, assume that the atom ID is 1.

Note that many atom structures contain two version fields, `majorVersion` and `minorVersion`. The values of these fields correspond to the constants `kQTVRMajorVersion` and `kQTVRMinorVersion` found in the header file `QuickTimeVRFormat.h`. For QuickTime 2.0 files, these values are 2 and 0.

QuickTime provides a number of routines for both creating and accessing atom containers.

Some of the leaf atoms within the VR world and node information atom containers contain fields that specify the ID of string atoms that are siblings of the leaf atom. For example, the VR world header atom contains a field for the name of the scene. The string atom is a leaf atom whose atom type is `kQTVRStringAtomType ('vrsg')`. Its atom ID is that specified by the referring leaf atom.

A string atom contains a string. The structure of a string atom is defined by the `QTVRStringAtom` data type.

```
typedef struct QTVRStringAtom {
    UInt16                stringUsage;
    UInt16                stringLength;
    unsigned char         theString[4];
} QTVRStringAtom, *QTVRStringAtomPtr;
```

**Field descriptions****stringUsage**

The string usage. This field is unused.

`stringLength`

The length, in bytes, of the string.

`theString`

The string. The string atom structure is extended to hold this string.

Each string atom may also have a sibling leaf atom, called the string encoding atom. The string encoding atom's atom type is `kQTVRStringEncodingAtomType ('vrse')`. Its atom ID is the same as that of the corresponding string atom. The string encoding atom contains a single variable, `TextEncoding`, a `UInt32`, as defined in the header file `TextCommon.h`. The value of `TextEncoding` is handed, along with the string, to the routine `QTTextToNativeText` for conversion for display on the current machine. The routine `QTTextToNativeText` is found in the header file `Movies.h`.

**Note:** The header file `TextCommon.h` contains constants and routines for generating and handling text encodings.

## VR World Atom Container

---

The VR world atom container (VR world for short) includes such information as the name for the entire scene, the default node ID, and default imaging properties, as well as a list of the nodes contained in the QTVR track.

A VR world can also contain custom scene information. QuickTime VR ignores any atom types that it doesn't recognize, but you can extract those atoms from the VR world using standard QuickTime atom functions.

The structure of the VR world atom container is shown in [Figure 3-16](#) (page 182). The component atoms are defined and their structures are shown in the sections that follow.

**Figure 3-16** Structure of the VR world atom container

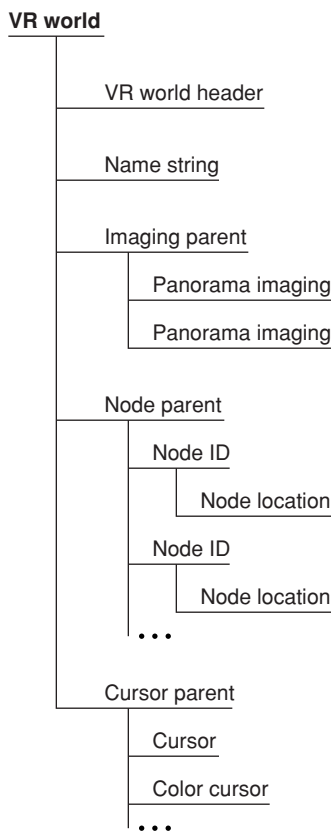

### VR World Header Atom Structure

The VR world header atom is a leaf atom. Its atom type is `kQTVRWorldHeaderAtomType ('vrsc')`. It contains the name of the scene and the default node ID to be used when the file is first opened as well as fields reserved for future use.

The structure of a VR world header atom is defined by the `QTVRWorldHeaderAtom` data type.

```

typedef struct VRWorldHeaderAtom {
    UInt16          majorVersion;
    UInt16          minorVersion;
    QTAtomID       nameAtomID;
    UInt32         defaultNodeID;
    UInt32         vrWorldFlags;
    UInt32         reserved1;
    UInt32         reserved2;
} VRWorldHeaderAtom, *QTVRWorldHeaderAtomPtr;
QT
QT
    
```

#### Field descriptions

`majorVersion`  
 The major version number of the file format.

minorVersion

The minor version number of the file format.

nameAtomID

The ID of the string atom that contains the name of the scene. That atom should be a sibling of the VR world header atom. The value of this field is 0 if no name string atom exists.

defaultNodeID

The ID of the default node (that is, the node to be displayed when the file is first opened).

vrWorldFlags

A set of flags for the VR world. This field is unused.

reserved1

Reserved. This field must be 0.

reserved2

Reserved. This field must be 0.

## Imaging Parent Atom

---

The imaging parent atom is the parent atom of one or more node-specific imaging atoms. Its atom type is `kQTVRImagingParentAtomType ('imgp')`. Only panoramas have an imaging atom defined.

## Panorama-Imaging Atom

---

A panorama-imaging atom describes the default imaging characteristics for all the panoramic nodes in a scene. This atom overrides QuickTime VR's own defaults.

The panorama-imaging atom has an atom type of `kQTVRPanoImagingAtomType ('impn')`. Generally, there is one panorama-imaging atom for each imaging mode, so the atom ID, while it must be unique for each atom, is ignored. QuickTime VR iterates through all the panorama-imaging atoms.

The structure of a panorama-imaging atom is defined by the `QTVRPanoImagingAtom` data type:

```
typedef struct QTVRPanoImagingAtom {
    UInt16          majorVersion;
    UInt16          minorVersion;
    UInt32          imagingMode;
    UInt32          imagingValidFlags;
    UInt32          correction;
    UInt32          quality;
    UInt32          directDraw;
    UInt32          imagingProperties[6];
    UInt32          reserved1;
    UInt32          reserved2;
} QTVRPanoImagingAtom, *VRPanoImagingAtomPtr;
```

### Field descriptions

majorVersion

The major version number of the file format.

minorVersion

The minor version number of the file format.

`imagingMode`

The imaging mode to which the default values apply. Only `kQTVRStatic` and `kQTVRMotion` are allowed here.

`imagingValidFlags`

A set of flags that indicate which imaging property fields in this structure are valid.

`correction`

The default correction mode for panoramic nodes. This can be either `kQTVRNoCorrection`, `kQTVRPartialCorrection`, or `kQTVRFullCorrection`.

`quality`

The default imaging quality for panoramic nodes.

`directDraw`

The default direct-drawing property for panoramic nodes. This can be `true` or `false`.

`imagingProperties`

Reserved for future panorama-imaging properties.

`reserved1`

Reserved. This field must be 0.

`reserved2`

Reserved. This field must be 0.

The `imagingValidFlags` field in the panorama-imaging atom structure specifies which imaging property fields in that structure are valid. You can use these bit flags to specify a value for that field:

```
enum {
    kQTVRValidCorrection           = 1 << 0,
    kQTVRValidQuality             = 1 << 1,
    kQTVRValidDirectDraw         = 1 << 2,
    kQTVRValidFirstExtraProperty = 1 << 3
};
```

### Constant descriptions

`kQTVRValidCorrection`

The default correction mode for panorama-imaging properties. If this bit is set, the `correction` field holds a default correction mode.

`kQTVRValidQuality`

The default imaging quality for panorama-imaging properties. If this bit is set, the `quality` field holds a default imaging quality.

`kQTVRValidDirectDraw`

The default direct-draw quality for panorama-imaging properties. If this bit is set, the `directDraw` field holds a default direct-drawing property.

`kQTVRValidFirstExtraProperty`

The default imaging property for panorama-imaging properties. If this bit is set, the first element in the array in the `imagingProperties` field holds a default imaging property. As new imaging properties are added, they will be stored in this array.



## Node Parent Atom

---

The node parent atom is the parent of one or more node ID atoms. The atom type of the node parent atom is `kQTVRNodeParentAtomType ('vrnp')` and the atom type of the each node ID atom is `kQTVRNodeIDAtomType ('vrni')`.

There is one node ID atom for each node in the file. The atom ID of the node ID atom is the node ID of the node. The node ID atom is the parent of the node location atom. The node location atom is the only child atom defined for the node ID atom. Its atom type is `kQTVRNodeLocationAtomType ('nloc')`.

## Node Location Atom Structure

---

The node location atom is the only child atom defined for the node ID atom. Its atom type is `kQTVRNodeLocationAtomType ('nloc')`. A node location atom describes the type of a node and its location.

The structure of a node location atom is defined by the `QTVRNodeLocationAtom` data type:

```
typedef struct VRNodeLocationAtom {  
    UInt16          majorVersion;  
    UInt16          minorVersion;  
    OSType          nodeType;  
    UInt32          locationFlags;  
    UInt32          locationData;  
    UInt32          reserved1;  
    UInt32          reserved2;  
} VRNodeLocationAtom, *QTVRNodeLocationAtomPtr;  
QT  
QT
```

### Field descriptions

`majorVersion`

The major version number of the file format.

`minorVersion`

The minor version number of the file format.

`nodeType`

The node type. This field should contain either `kQTVRPanoramaType` or `kQTVRObjectType`.

`locationFlags`

The location flags. This field must contain the value `kQTVRSameFile`, indicating that the node is to be found in the current file. In future, these flags may indicate that the node is in a different file or at some URL location.

`locationData`

The location of the node data. When the `locationFlags` field is `kQTVRSameFile`, this field should be 0. The nodes are found in the file in the same order that they are found in the node list.

reserved1

Reserved. This field must be 0.

reserved2

Reserved. This field must be 0.

## Custom Cursor Atoms

---

The hot spot information atom, discussed in “[Hot Spot Information Atom](#)” (page 188), allows you to indicate custom cursor IDs for particular hot spots that replace the default cursors used by QuickTime VR. QuickTime VR allows you to store your custom cursors in the VR world of the movie file.

**Note:** If you’re using the Mac OS, you could store your custom cursors in the resource fork of the movie file. However, this would not work on any other platform (such as Windows), so storing cursors in the resource fork of the movie file is not recommended.

The cursor parent atom is the parent of all of the custom cursor atoms stored in the VR world. Its atom type is `kQTVRCursorParentAtomType ('vrCP')`. The child atoms of the cursor parent are either cursor atoms or color cursor atoms. Their atom types are `kQTVRCursorAtomType ('CURS')` and `kQTVRColorCursorAtomType ('crsr')`. These atoms are stored exactly as cursors or color cursors would be stored as a resource.

## Node Information Atom Container

---

The node information atom container includes general information about the node such as the node’s type, ID, and name. The node information atom container also contains the list of hot spot atoms for the node. A QuickTime VR movie contains one node information atom container for each node in the file. The routine `QTVRGetNodeInfo` allows you to obtain the node information atom container for the current node or for any other node in the movie.

[Figure 3-17](#) (page 187) shows the structure of the node information atom container.

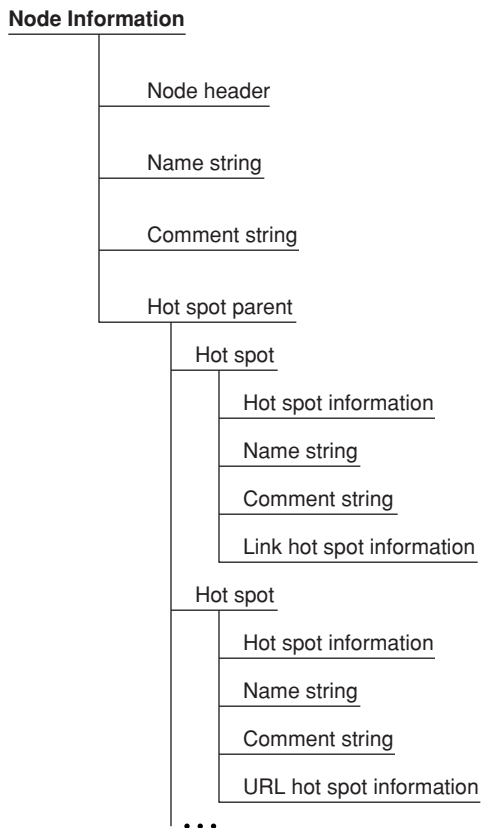
**Figure 3-17** Structure of the node information atom container

## Node Header Atom Structure

---

A node header atom is a leaf atom that describes the type and ID of a node, as well as other information about the node. Its atom type is `kQTVRNodeHeaderAtomType ('ndhd')`.

The structure of a node header atom is defined by the `QTVRNodeHeaderAtom` data type:

```

typedef struct VRNodeHeaderAtom {
    UInt16          majorVersion;
    UInt16          minorVersion;
    OSType         nodeType;
    QTAtomID       nodeID;
    QTAtomID       nameAtomID;
    QTAtomID       commentAtomID;
    UInt32         reserved1;
    UInt32         reserved2;
} VRNodeHeaderAtom, *VRNodeHeaderAtomPtr;
  
```

### Field descriptions

`majorVersion`

The major version number of the file format.

minorVersion

The minor version number of the file format.

nodeType

The node type. This field should contain either `kQTVRPanoramaType` or `kQTVRObjectType`.

nodeID

The node ID.

nameAtomID

The ID of the string atom that contains the name of the node. This atom should be a sibling of the node header atom. The value of this field is 0 if no name string atom exists.

commentAtomID

The ID of the string atom that contains a comment for the node. This atom should be a sibling of the node header atom. The value of this field is 0 if no comment string atom exists.

reserved1

Reserved. This field must be 0.

reserved2

Reserved. This field must be 0.

## Hot Spot Parent Atom

---

The hot spot parent atom is the parent for all hot spot atoms for the node. The atom type of the hot spot parent atom is `kQTVRHotSpotParentAtomType ('hspace')` and the atom type of the each hot spot atom is `kQTVRHotSpotAtomType ('hots')`. The atom ID of each hot spot atom is the hot spot ID for the corresponding hot spot. The hot spot ID is determined by its color index value as it is stored in the hot spot image track.

The hot spot track is an 8-bit video track that contains color information that indicates hot spots. For more information, refer to *Programming With QuickTime VR*.

Each hot spot atom is the parent of a number of atoms that contain information about each hot spot.

## Hot Spot Information Atom

---

The hot spot information atom contains general information about a hot spot. Its atom type is `kQTVRHotSpotInfoAtomType ('hsinfo')`. Every hot spot atom should have a hot spot information atom as a child.

The structure of a hot spot information atom is defined by the `QTVRHotSpotInfoAtom` data type:

```
typedef struct VRHotSpotInfoAtom {
    UInt16          majorVersion;
    UInt16          minorVersion;
    OSType          hotSpotType;
    QTAtomID        nameAtomID;
    QTAtomID        commentAtomID;
    Sint32          cursorID[3];
    Float32         bestPan;
    Float32         bestTilt;
```

```

Float32                bestFOV;
FloatPoint             bestViewCenter;
Rect                  hotSpotRect;
UInt32                flags;
UInt32                reserved1;
UInt32                reserved2;
} VRHotSpotInfoAtom, *QTVRHotSpotInfoAtomPtr;

```

**Field descriptions**

majorVersion

The major version number of the file format.

minorVersion

The minor version number of the file format.

hotSpotType

The hot spot type. This type specifies which other information atoms—if any—are siblings to this one. QuickTime VR recognizes three types: `kQTVRHotSpotLinkType`, `kQTVRHotSpotURLType`, and `kQTVRHotSpotUndefinedType`.

nameAtomID

The ID of the string atom that contains the name of the hot spot. This atom should be a sibling of the hot spot information atom. This string is displayed in the QuickTime VR controller bar when the mouse is moved over the hot spot.

commentAtomID

The ID of the string atom that contains a comment for the hot spot. This atom should be a sibling of the hot spot information atom. The value of this field is 0 if no comment string atom exists.

cursorID

An array of three IDs for custom hot spot cursors (that is, cursors that override the default hot spot cursors provided by QuickTime VR). The first ID (`cursorID[0]`) specifies the cursor that is displayed when it is in the hot spot. The second ID (`cursorID[1]`) specifies the cursor that is displayed when it is in the hot spot and the mouse button is down. The third ID (`cursorID[2]`) specifies the cursor that is displayed when it is in the hot spot and the mouse button is released. To retain the default cursor for any of these operations, set the corresponding cursor ID to 0. Custom cursors should be stored in the VR world atom container, as described in [“VR World Atom Container”](#) (page 181).

bestPan

The best pan angle for viewing this hot spot.

bestTilt

The best tilt angle for viewing this hot spot.

bestFOV

The best field of view for viewing this hot spot.

bestViewCenter

The best view center for viewing this hot spot; applies only to object nodes.

hotSpotRect

The boundary box for this hot spot, specified as the number of pixels in full panoramic space. This field is valid only for panoramic nodes.

flags

A set of hot spot flags. This field is unused.

reserved1

Reserved. This field must be 0.

reserved2

Reserved. This field must be 0.

**Note:** In QuickTime VR movie files, all angular values are stored as 32-bit floating-point values that specify degrees. In addition, all floating-point values conform to the IEEE Standard 754 for binary floating-point arithmetic, in big-endian format.

## Specific Information Atoms

---

Depending on the value of the `hotSpotType` field in the hot spot info atom there may also be a type specific information atom. The atom type of the type-specific atom is the hot spot type.

## Link Hot Spot Atom

---

The link hot spot atom specifies information for hot spots of type `kQTVRHotSpotLinkType ('link')`. Its atom type is thus `'link'`. The link hot spot atom contains specific information about a link hot spot.

The structure of a link hot spot atom is defined by the `QTVRLinkHotSpotAtom` data type:

```
typedef struct VRLinkHotSpotAtom {
    UInt16          majorVersion;
    UInt16          minorVersion;
    UInt32          toNodeID;
    UInt32          fromValidFlags;
    Float32         fromPan;
    Float32         fromTilt;
    Float32         fromFOV;
    FloatPoint      fromViewCenter;
    UInt32          toValidFlags;
    Float32         toPan;
    Float32         toTilt;
    Float32         toFOV;
    FloatPoint      toViewCenter;
    Float32         distance;
    UInt32          flags;
    UInt32          reserved1;
    UInt32          reserved2;
} VRLinkHotSpotAtom, *VRLinkHotSpotAtomPtr;
```

### Field descriptions

`majorVersion`

The major version number of the file format.

minorVersion

The minor version number of the file format.

toNodeID

The ID of the destination node (that is, the node to which this hot spot is linked).

fromValidFlags

A set of flags that indicate which source node view settings are valid.

fromPan

The preferred from-pan angle at the source node (that is, the node containing the hot spot).

fromTilt

The preferred from-tilt angle at the source node.

fromFOV

The preferred from-field of view at the source node.

fromViewCenter

The preferred from-view center at the source node.

toValidFlags

A set of flags that indicate which destination node view settings are valid.

toPan

The pan angle to use when displaying the destination node.

toTilt

The tilt angle to use when displaying the destination node.

toFOV

The field of view to use when displaying the destination node.

toViewCenter

The view center to use when displaying the destination node.

distance

The distance between the source node and the destination node.

flags

A set of link hot spot flags. This field is unused and should be set to 0.

reserved1

Reserved. This field must be 0.

reserved2

Reserved. This field must be 0.

Certain fields in the link hot spot atom are not used by QuickTime VR. The `fromValidFlags` field is generally set to 0 and the other `from` fields are not used. However, these fields could be quite useful if you have created a transition movie from one node to another. The `from` angles can be used to swing the current view of the source node to align with the first frame of the transition movie. The `distance` field is intended for use with 3D applications, but is also not used by QuickTime VR.

## Link Hot Spot Valid Flags

---

The `toValidFlags` field in the link hot spot atom structure specifies which view settings are to be used when moving to a destination node from a hot spot. You can use these bit flags to specify a value for that field:

```
enum {
    kQTVRValidPan           = 1 << 0,
    kQTVRValidTilt         = 1 << 1,
    kQTVRValidFOV          = 1 << 2,
    kQTVRValidViewCenter   = 1 << 3
};
```

### Constant descriptions

`kQTVRValidPan`  
The setting for using the destination pan angle.

`kQTVRValidTilt`  
The setting for using the destination tilt angle.

`kQTVRValidFOV`  
The setting for using the destination field of view.

`kQTVRValidViewCenter`  
The setting for using the destination view center.

## URL Hot Spot Atom

---

The URL hot spot atom has an atom type of `kQTVRHotSpotURLType ('url ')`. The URL hot spot atom contains a URL string for a particular Web location (for example, `http://quicktimevr.apple.com`). QuickTime VR automatically links to this URL when the hot spot is clicked.

## Support for Wired Actions

---

Certain actions on a QuickTime VR movie can trigger wired actions if the appropriate event handler atoms have been added to the file. This section discusses what atoms must be included in the QuickTime VR file to support wired actions.

As with sprite tracks, the presence of a certain atom in the media property atom container of the QTVR track enables the handling of wired actions. This atom is of type `kSpriteTrackPropertyHasActions`, which has a single Boolean value that must be set to `true`.

When certain events occur and the appropriate event handler atom is found in the QTVR file, then that atom is passed to QuickTime to perform any actions specified in the atom. The event handler atoms themselves must be added to the node information atom container in the QTVR track. There are two types of event handlers for QTVR nodes: global and hot spot specific. The currently supported



global event handlers are `kQTEventFrameLoaded` and `kQTEventIdle`. The event handler atoms for these are located at the root level of the node information atom container. A global event handler atom's type is set to the event type and its ID is set to 1.

Hot spot–specific event handler atoms are located in the specific hot spot atom as a sibling to the hot spot info atom. For these atoms, the atom type is always `kQTEventType` and the ID is the event type. Supported hot spot–specific event types are `kQTEventMouseClicked`, `kQTEventMouseClickedEnd`, `kQTEventMouseClickedEndTriggerButton`, and `kQTEventMouseEnter`, `kQTEventMouseExit`.

The specific actions that cause these events to be generated are described as follows:

`kQTEventFrameLoaded ('fram')`

A wired action that is generated when a node is entered, before any application-installed entering-node procedure is called (this event processing is considered part of the node setup that occurs before the application's routine is called).

`kQTEventIdle ('idle')`

A wired action that is generated every *n* ticks, where *n* is defined by the contents of the `kSpriteTrackPropertyQTIdleEventsFrequency` atom (`SInt32`) in the media property atom container. When appropriate, this event is triggered before any normal idle processing occurs for the QuickTime VR movie.

`kQTEventMouseClicked ('clik')`

A wired action that is generated when the mouse goes down over a hot spot.

`kQTEventMouseClickedEnd ('cend')`

A wired action that is generated when the mouse goes up after a `kQTEventMouseClicked` is generated, regardless of whether the mouse is still over the hot spot originally clicked. This event occurs prior to QuickTime VR's normal mouse-up processing.

`kQTEventMouseClickedEndTriggerButton ('trig')`

A wired action that is generated when a click end triggers a hot spot (using the same criterion as used by QuickTime VR in 2.1 for link/url hot spot execution). This event occurs prior to QuickTime VR's normal hot spot–trigger processing.

`kQTEventMouseEnter ('entr')`, `kQTEventMouseExit ('exit')`

Wired action that are generated when the mouse rolls into or out of a hot spot, respectively. These events occur whether or not the mouse is down and whether or not the movie is being panned. These events occur after any application-installed `MouseOverHotSpotProc` is called, and will be cancelled if the return value from the application's routine indicates that QuickTimeVR's normal over–hot spot processing should not take place.

## QuickTime VR File Format

---

A QuickTime VR movie is stored on disk in a format known as the QuickTime VR file format. Beginning in QuickTime VR 2.0, a QuickTime VR movie could contain one or more nodes. Each node is either a panorama or an object. In addition, a QuickTime VR movie could contain various types of hot spots, including links between any two types of nodes.

**Important:** This section describes the file format supported by version 2.1 of the QuickTime VR Manager.

All QuickTime VR movies contain a single QTVR track, a special type of QuickTime track that maintains a list of the nodes in the movie. Each individual sample in a QTVR track contains general information and hot spot information for a particular node.

If a QuickTime VR movie contains any panoramic nodes, that movie also contains a single panorama track, and if it contains any object nodes, it also contains a single object track. The panorama and object tracks contain information specific to the panoramas or objects in the movie. The actual image data for both panoramas and objects is usually stored in standard QuickTime video tracks, hereafter referred to as image tracks. (An image track can also be any type of track that is capable of displaying an image, such as a QuickTime 3D track.) The individual frames in the image track for a panorama make up the diced frames of the original single panoramic image. The frames for the image track of an object represent the many different views of the object. Hot spot image data is stored in parallel video tracks for both panoramas and objects.

## Single-Node Panoramic Movies

Figure 3-18 (page 194) illustrates the basic structure of a single-node panoramic movie. As you can see, every panoramic movie contains at least three tracks: a QTVR track, a panorama track, and a panorama image track.

**Figure 3-18** The structure of a single-node panoramic movie file

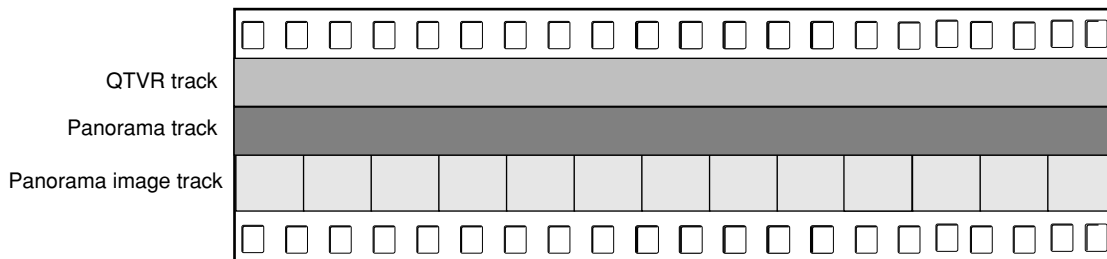

For a single-node panoramic movie, the QTVR track contains just one sample. There is a corresponding sample in the panorama track, whose time and duration are the same as the time and duration of the sample in the QTVR track. The time base of the movie is used to locate the proper video samples in the panorama image track. For a panoramic movie, the video sample for the first diced frame of a node’s panoramic image is located at the same time as the corresponding QTVR and panorama track samples. The total duration of all the video samples is the same as the duration of the corresponding QTVR sample and the panorama sample.

A panoramic movie can contain an optional hot spot image track and any number of standard QuickTime tracks. A panoramic movie can also contain panoramic image tracks with a lower resolution. The video samples in these low-resolution image tracks must be located at the same time and must have the same total duration as the QTVR track. Likewise, the video samples for a hot spot image track, if one exists, must be located at the same time and must have the same total duration as the QTVR track.

## Single-Node Object Movies

Figure 3-19 (page 195) illustrates the basic structure of a single-node object movie. As you can see, every object movie contains at least three tracks: a QTVR track, an object track, and an object image track.

**Figure 3-19** The structure of a single-node object movie file

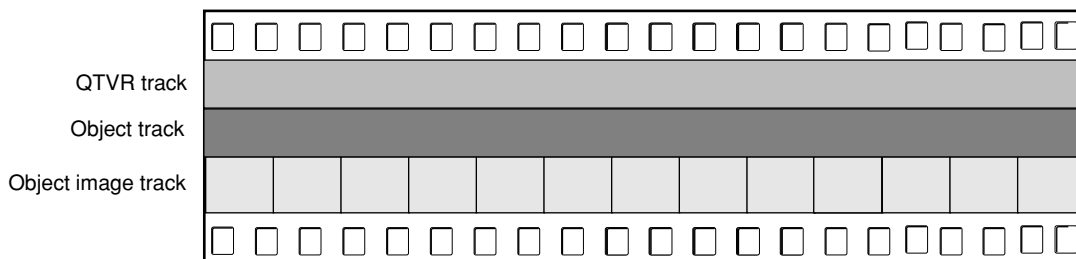

For a single-node object movie, the QTVR track contains just one sample. There is a corresponding sample in the object track, whose time and duration are the same as the time and duration of the sample in the QTVR track. The time base of the movie is used to locate the proper video samples in the object image track.

For an object movie, the frame corresponding to the first row and column in the object image array is located at the same time as the corresponding QTVR and object track samples. The total duration of all the video samples is the same as the duration of the corresponding QTVR sample and the object sample.

In addition to these three required tracks, an object movie can also contain a hot spot image track and any number of standard QuickTime tracks (such as video, sound, and text tracks). A hot spot image track for an object is a QuickTime video track that contains images of colored regions delineating the hot spots; an image in the hot spot image track must be synchronized to match the appropriate image in the object image track. A hot spot image track should be 8 bits deep and can be compressed with any lossless compressor (including temporal compressors). This is also true of panoramas.

**Note:** To assign a single fixed-position hot spot to all views of an object, you should create a hot spot image track that consists of a single video frame whose duration is the entire node time.

To play a time-based track with the object movie, you must synchronize the sample data of that track to the start and stop times of a view in the object image track. For example, to play a different sound with each view of an object, you might store a sound track in the movie file with each set of sound samples synchronized to play at the same time as the corresponding object's view image. (This technique also works for video samples.) Another way to add sound or video is simply to play a sound or video track during the object's view animation; to do this, you need to add an active track to the object that is equal in duration to the object's row duration.

**Important:** In a QuickTime VR movie file, the panorama image tracks and panorama hot spot tracks must be disabled. For an object, the object image tracks must be enabled and the object hot spot tracks must be disabled.

## Multinode Movies

A multinode QuickTime VR movie can contain any number of object and panoramic nodes. [Figure 3-20](#) (page 196) illustrates the structure of a QuickTime VR movie that contains five nodes (in this case, three panoramic nodes and two object nodes).

**Figure 3-20** The structure of a multinode movie file

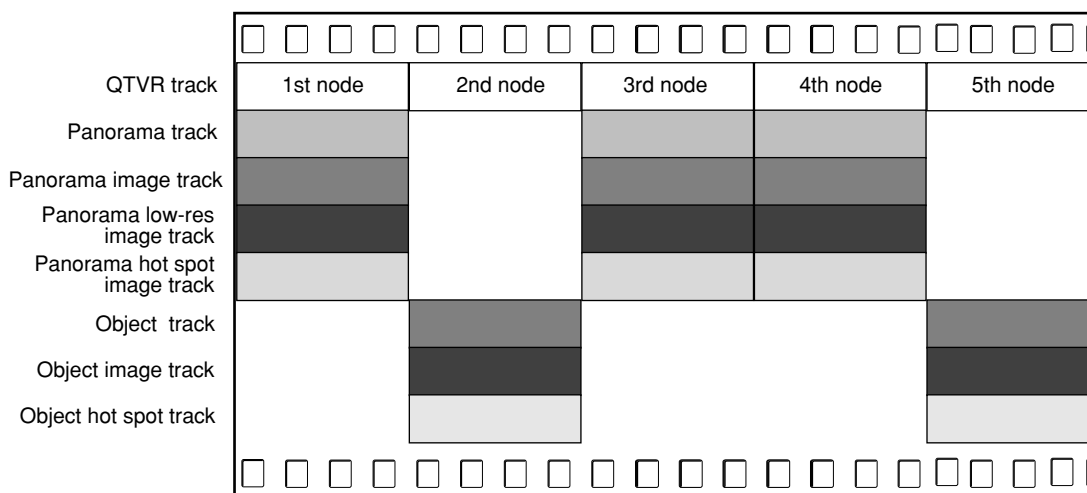

**Important:** Panoramic tracks and object tracks must never be located at the same time.

## QTVR Track

A QTVR track is a special type of QuickTime track that maintains a list of all the nodes in a movie. The media type for a QTVR track is 'qtvvr'. All the media samples in a QTVR track share a common sample description. This sample description contains the VR world atom container. The track contains one media sample for each node in the movie. Each QuickTime VR media sample contains a node information atom container.

## QuickTime VR Sample Description Structure

---

Whereas the QuickTime VR media sample is simply the node information itself, all sample descriptions are required by QuickTime to have a certain structure for the first several bytes. The structure for the QuickTime VR sample description is as follows:

```
typedef struct QTVRSampleDescription {
    UInt32          size;
    UInt32          type;
    UInt32          reserved1;
    UInt16          reserved2;
    UInt16          dataRefIndex;
    UInt32          data;
} QTVRSampleDescription, *QTVRSampleDescriptionPtr, **QTVRSampleDescriptionHandle;
```

### Field descriptions

size

The size, in bytes, of the sample description header structure, including the VR world atom container contained in the data field.

type

The sample description type. For QuickTime VR movies, this type should be 'qtvr'.

reserved1

Reserved. This field must be 0.

reserved2

Reserved. This field must be 0.

dataRefIndex

Reserved. This field must be 0.

data

The VR world atom container. The sample description structure is extended to hold this atom container.

## Panorama Tracks

---

A movie's panorama track is a track that contains information about the panoramic nodes in a scene. The media type of the panorama track is 'pano'. Each sample in a panorama track corresponds to a single panoramic node. This sample parallels the corresponding sample in the QTVR track. Panorama tracks do not have a sample description (although QuickTime requires that you specify a dummy sample description when you call `AddMediaSample` to add a sample to a panorama track). The sample itself contains an atom container that includes a panorama sample atom and other optional atoms.

## Panorama Sample Atom Structure

---

A panorama sample atom has an atom type of `kQTVRPanoSampleDataAtomType ('pdat')`. It describes a single panorama, including track reference indexes of the scene and hot spot tracks and information about the default viewing angles and the source panoramic image.

The structure of a panorama sample atom is defined by the `QTVRPanoSampleAtom` data type:

```
typedef struct VRPanoSampleAtom {
    UInt16          majorVersion;
    UInt16          minorVersion;
    UInt32          imageRefTrackIndex;
    UInt32          hotSpotRefTrackIndex;
    Float32         minPan;
    Float32         maxPan;
    Float32         minTilt;
    Float32         maxTilt;
    Float32         minFieldOfView;
    Float32         maxFieldOfView;
    Float32         defaultPan;
    Float32         defaultTilt;
    Float32         defaultFieldOfView;
    UInt32          imageSizeX;
    UInt32          imageSizeY;
    UInt16          imageNumFramesX;
    UInt16          imageNumFramesY;
    UInt32          hotSpotSizeX;
    UInt32          hotSpotSizeY;
    UInt16          hotSpotNumFramesX;
    UInt16          hotSpotNumFramesY;
    UInt32          flags;
    OSType          panoType;
    UInt32          reserved2;
} VRPanoSampleAtom, *VRPanoSampleAtomPtr;
```

### Field descriptions

`majorVersion`

The major version number of the file format.

`minorVersion`

The minor version number of the file format.

`imageRefTrackIndex`

The index of the image track reference. This is the index returned by the `AddTrackReference` function when the image track is added as a reference to the panorama track. There can be more than one image track for a given panorama track and hence multiple references. (A panorama track might have multiple image tracks if the panoramas have different characteristics, which could occur if the panoramas were shot with different size camera lenses.) The value in this field is 0 if there is no corresponding image track.

`hotSpotRefTrackIndex`

The index of the hot spot track reference.

`minPan`

The minimum pan angle, in degrees. For a full panorama, the value of this field is usually 0.0.

maxPan

The maximum pan angle, in degrees. For a full panorama, the value of this field is usually 360.0.

minTilt

The minimum tilt angle, in degrees. For a high-resolution panorama, a typical value for this field is -42.5.

maxTilt

The maximum tilt angle, in degrees. For a high-resolution panorama, a typical value for this field is +42.5.

minFieldOfView

The minimum vertical field of view, in degrees. For a high-resolution panorama, a typical value for this field is 5.0. The value in this field is 0 for the default minimum field of view, which is 5 percent of the maximum field of view.

maxFieldOfView

The maximum vertical field of view, in degrees. For a high-resolution panorama, a typical value for this field is 85.0. The value in this field is 0 for the default maximum field of view, which is  $\text{maxTilt} - \text{minTilt}$ .

defaultPan

The default pan angle, in degrees.

defaultTilt

The default tilt angle, in degrees.

defaultFieldOfView

The default vertical field of view, in degrees.

imageSizeX

The width, in pixels, of the panorama stored in the highest resolution image track.

imageSizeY

The height, in pixels, of the panorama stored in the highest resolution image track.

imageNumFramesX

The number of frames into which the panoramic image is diced horizontally. The width of each frame (which is  $\text{imageSizeX} / \text{imageNumFramesX}$ ) should be divisible by 4.

imageNumFramesY

The number of frames into which the panoramic image is diced vertically. The height of each frame (which is  $\text{imageSizeY} / \text{imageNumFramesY}$ ) should be divisible by 4.

hotSpotSizeX

The width, in pixels, of the panorama stored in the highest resolution hot spot image track.

hotSpotSizeY

The height, in pixels, of the panorama stored in the highest resolution hot spot image track.

hotSpotNumFramesX

The number of frames into which the panoramic image is diced horizontally for the hot spot image track.

hotSpotNumFramesY

The number of frames into which the panoramic image is diced vertically for the hot spot image track.

flags

A set of panorama flags. `kQTVRPanoFlagHorizontal` has been superseded by the `panoType` field. It is only used when the `panoType` field is `nil` to indicate a horizontally-oriented cylindrical panorama. `kQTVRPanoFlagAlwaysWrap` is set if the panorama should wrap horizontally, regardless of whether or not the pan range is 360 degrees. Note that these flags are currently supported only under Mac OS X.

panoType

An OSType describing the type of panorama. Types supported are

`kQTVRHorizontalCylinder`

`kQTVRVerticalCylinder`

`kQTVRCube`

reserved2

Reserved. This field must be 0.

**Important:** A new flag has been added to the flags field of the `QTVRPanoSampleAtom` data structure. This flag controls how panoramas wrap horizontally. If `kQTVRPanoFlagAlwaysWrap` is set, then the panorama wraps horizontally, regardless of the number of degrees in the panorama. If the flag is not set, then the panorama wraps only when the panorama range is 360 degrees. This is the default behavior.

The minimum and maximum values in the panorama sample atom describe the physical limits of the panoramic image. QuickTime VR allows you to set further constraints on what portion of the image a user can see by calling the `QTVRSetConstraints` routine. You can also preset image constraints by adding constraint atoms to the panorama sample atom container. The three constraint atom types are `kQTVRPanConstraintAtomType`, `kQTVRTiltConstraintAtomType`, and `kQTVRFOVConstraintAtomType`. Each of these atom types share a common structure defined by the `QTVRAngleRangeAtom` data type:

```
typedef struct QTVRAngleRangeAtom {
    Float32          minimumAngle;
    Float32          maximumAngle;
} QTVRAngleRangeAtom, *QTVRAngleRangeAtomPtr;
```

#### Field descriptions

minimumAngle

The minimum angle in the range, in degrees.

maximumAngle

The maximum angle in the range, in degrees.



## Panorama Image Track

The actual panoramic image for a panoramic node is contained in a panorama image track, which is a standard QuickTime video track. The track reference to this track is stored in the `imageRefTrackIndex` field of the panorama sample atom.

QuickTime VR 2.1 required the original panoramic image to be rotated 90 degrees counterclockwise. This orientation has changed in QuickTime VR 2.2, however, as discussed later in this section.

The rotated image is diced into smaller frames, and each diced frame is then compressed and added to the video track as a video sample, as shown in [Figure 3-21](#) (page 201). Frames can be compressed using any spatial compressor; however, temporal compression is not allowed for panoramic image tracks.

**Figure 3-21** Creating an image track for a panorama

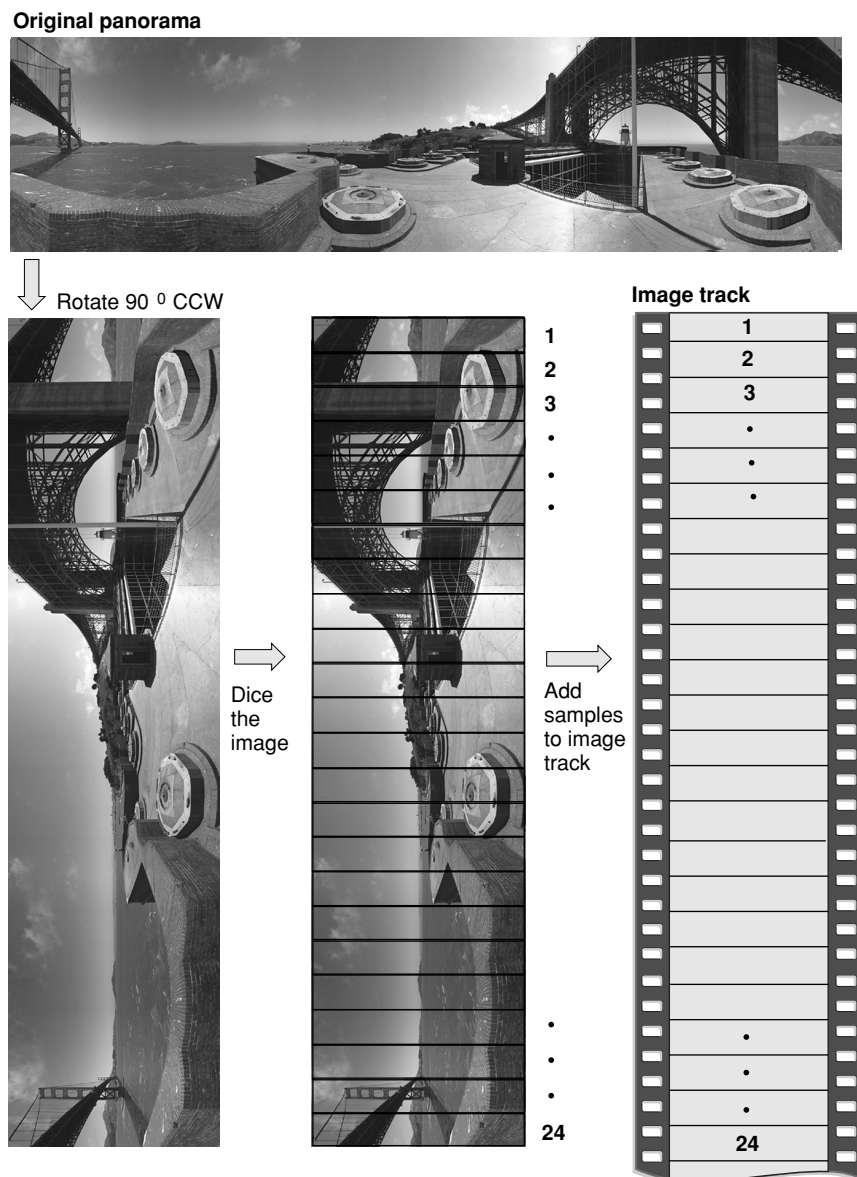

QuickTime VR 2.2 does not require the original panoramic image to be rotated 90 degrees counterclockwise, as was the case in QuickTime VR 2.1. The rotated image is still diced into smaller frames, and each diced frame is then compressed and added to the video track as a video sample, as shown in [Figure 3-22](#) (page 202).

**Figure 3-22** Creating an image track for a panorama, with the image track oriented horizontally

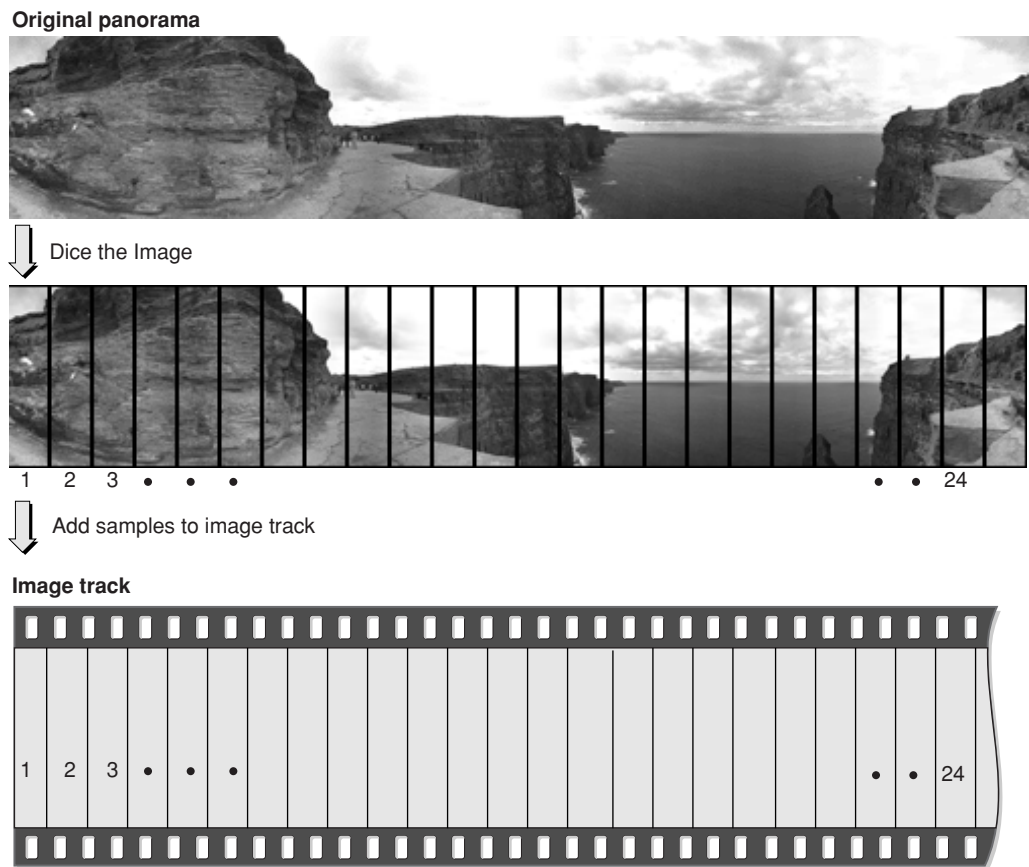

In QuickTime 3.0, a panorama sample atom (which contains information about a single panorama) contains the `panoType` field, which indicates whether the diced panoramic image is oriented horizontally or vertically.

## Cylindrical Panoramas

The primary change to cylindrical panoramas in QuickTime VR 2.2 is that the panorama, as stored in the image track of the movie, can be oriented horizontally. This means that the panorama does not need to be rotated 90 degrees counterclockwise, as required previously.

To indicate a horizontal orientation, the field in the `VRPanoSampleAtom` data structure formerly called `reserved1` has been renamed `panoType`. Its type is `OSType`. The `panoType` field value for a horizontally oriented cylinder is `kQTVRHorizontalCylinder ('hcyl')`, while a vertical cylinder is `kQTVRVerticalCylinder ('vcyl')`. For compatibility with older QuickTime VR files, when the `panoType` field is `nil`, then a cylinder is assumed, with the low order bit of the `flags` field set to 1 to indicate if the cylinder is horizontal and 0 if the cylinder is vertical.

One consequence of reorienting the panorama horizontally is that, when the panorama is divided into separate tiles, the order of the samples in the file is now the reverse of what it was for vertical cylinders. Since vertical cylinders were rotated 90 degrees counterclockwise, the first tile added to the image track was the rightmost tile in the panorama. For unrotated horizontal cylinders, the first tile added to the image track is the left-most tile in the panorama.

## Cubic Panoramas

---

A new type of panorama was introduced in the current version of QuickTime: the cubic panorama. This panorama in its simplest form is represented by six faces of a cube, thus enabling the viewer to see all the way up and all the way down. The file format and the cubic rendering engine actually allow for more complicated representations, such as special types of cubes with elongated sides or cube faces made up of separate tiles. Atoms that describe the orientation of each face allow for these nonstandard representations. If these atoms are not present, then the simplest representation is assumed. The following describes this simplest representation: a cube with six square sides.

Tracks in a cubic movie are laid out as they are for cylindrical panoramas. This includes a QTVR track, a panorama track, and an image track. Optionally, there may also be a hot spot track and a fast-start preview track. The image, hot spot, and preview tracks are all standard QuickTime video tracks.

### Image Tracks in Cubic Nodes

---

For a cubic node the image track contains six samples that correspond to the six square faces of the cube. The same applies to hot spot and preview tracks. The following diagram shows how the order of samples in the track corresponds to the orientation of the cube faces:

Track samples

1	2	3	4	5	6
---	---	---	---	---	---

Cube faces

5			
1	2	3	4
6			

Note that the frames are oriented horizontally. There is no provision for frames that are rotated 90 degrees counterclockwise as there are for cylindrical panoramas.

## Panorama Tracks in Cubic Nodes

---

The media sample for a panorama track contains the pano sample atom container. For cubes, some of the fields in the pano sample data atom have special values, which provide compatibility back to QuickTime VR 2.2. The cubic projection engine ignores these fields. They allow one to view cubic movies in older versions of QuickTime VR using the cylindrical engine, although the view will be somewhat incorrect, and the top and bottom faces will not be visible. The special values are shown in [Table 3-15](#) (page 204).

**Table 3-15** Fields and their special values as represented in the pano sample data atom, providing backward compatibility to QuickTime VR 2.2

Field	Value
imageNumFramesX	4
imageNumFramesY	1
imageSizeX	Frame width * 4
imageSizeY	Frame height
minPan	0.0
maxPan	360.0
minTilt	-45.0
maxTilt	45.0
minFieldOfView	5.0
maxFieldOfView	90.0
flags	1

A 1 value in the flags field tells QuickTime VR 2.2 that the frames are not rotated. QuickTime VR 2.2 treats this as a four-frame horizontal cylinder. The `panoType` field (formerly `reserved1`) must be set to `kQTVRCube` ('cube') so that QuickTime VR 3.0 can recognize this panorama as a cube.

Since certain viewing fields in the pano sample data atom are being used for backward compatibility, a new atom must be added to indicate the proper viewing parameters for the cubic image. This atom is the cubic view atom (atom type 'cuvw'). The data structure of the cubic view atom is as follows:

```
struct QTVRCubicViewAtom {
    Float32    minPan;
    Float32    maxPan;
    Float32    minTilt;
    Float32    maxTilt;
    Float32    minFieldOfView;
    Float32    maxFieldOfView;

    Float32    defaultPan;
    Float32    defaultTilt;
}
```

```
Float32      defaultFieldOfView;
};
typedef struct QTVRcubicViewAtom    QTVRcubicViewAtom;
```

The fields are filled in as desired for the cubic image. This atom is ignored by older versions of QuickTime VR. Typical minimum and maximum field values are shown in [Table 3-16](#) (page 205).

**Table 3-16** Values for min and max fields

Field	Value
minPan	0.0
maxPan	360.0
minTilt	-90.0
maxTilt	90.0
minFieldOfView	5.0
maxFieldOfView	120.0

You add the cubic view atom to the pano sample atom container (after adding the pano sample data atom). Then use `AddMediaSample` to add the atom container to the panorama track.

## Nonstandard Cubes

---

Although the default representation for a cubic panorama is that of six square faces of a cube, it is possible to depart from this standard representation. When doing so, a new atom must be added to the pano sample atom container. The atom type is 'cufa'. The atom is an array of data structures of type `QTVRcubicFaceData`. Each entry in the array describes one face of whatever polyhedron is being defined. `QTVRcubicFaceData` is defined as follows:

```
struct QTVRcubicFaceData {
    float    orientation[4];
    float    center[2];
    float    aspect;
    float    skew;
};
typedef struct QTVRcubicFaceData    QTVRcubicFaceData;
```

The mathematical explanation of these data structures is beyond the scope of this document but will be described in a separate Apple Technote. [Table 3-17](#) (page 205) shows what values QuickTime VR uses for the default representation of six square sides.

**Table 3-17** Values used for representing six square sides

Orientation	Orientation	Orientation	Orientation	Center	Center	Aspect	Skew	Side
1	0	0	0	0	0	1	0	# front

Orientation	Orientation	Orientation	Orientation	Center	Center	Aspect	Skew	Side
-.5	0	.5	0	0	0	1	0	# right
0	0	1	0	0	0	1	0	# back
.5	0	.5	0	0	0	1	0	# left
.5	.5	0	0	0	0	1	0	# top
-.5	.5	0	0	0	0	1	0	# bottom

## Hot Spot Image Tracks

---

When a panorama contains hot spots, the movie file contains a hot spot image track, a video track that contains a parallel panorama, with the hot spots designated by colored regions. Each diced frame of the hot spot panoramic image must be compressed with a lossless compressor (such as QuickTime's graphics compressor). The dimensions of the hot spot panoramic image are usually the same as those of the image track's panoramic image, but this is not required. The dimensions must, however, have the same aspect ratio as the image track's panoramic image. A hot spot image track should be 8 bits deep.

## Low-Resolution Image Tracks

---

It's possible to store one or more low-resolution versions of a panoramic image in a movie file; those versions are called low-resolution image tracks. If there is not enough memory at runtime to use the normal image track, QuickTime VR uses a lower resolution image track if one is available. A low-resolution image track contains diced frames just like the higher resolution track, but the reconstructed panoramic image is half the height and half the width of the higher resolution image.

**Important:** The panoramic images in the lower resolution image tracks and the hot spot image tracks, if present, must have the same orientation (horizontal or vertical) as the panorama image track.

## Track Reference Entry Structure

---

Since there are no fields in the pano sample data atom to indicate the presence of low-resolution image tracks, a separate sibling atom must be added to the panorama sample atom container. The track reference array atom contains an array of track reference entry structures that specify information about any low-resolution image tracks contained in a movie. Its atom type is `kQTVRTrackRefArrayAtomType ('tref')`.

A track reference entry structure is defined by the `QTVRTrackRefEntry` data type:

```
typedef struct QTVRTrackRefEntry {
    UInt32                trackRefType;
    UInt16                trackResolution;
    UInt32                trackRefIndex;
```

```
} QTVRTrackRefEntry;
```

### Field descriptions

`trackRefType`

The track reference type.

`trackResolution`

The track resolution.

`trackRefIndex`

The index of the track reference.

The number of entries in the track reference array atom is determined by dividing the size of the atom by `sizeof(QTVRTrackRefEntry)`.

`kQTVRPreviewTrackRes` is a special value for the `trackResolution` field in the `QTVRTrackRefEntry` structure. This is used to indicate the presence of a special preview image track.

## Object Tracks

---

A movie's object track is a track that contains information about the object nodes in a scene. The media type of the object track is 'obje'. Each sample in an object track corresponds to a single object node in the scene. The samples of the object track contain information describing the object images stored in the object image track.

These object information samples parallel the corresponding node samples in the QTVR track and are equal in time and duration to a particular object node's image samples in the object's image track as well as the object node's hot spot samples in the object's hot spot track.

Object tracks do not have a sample description (although QuickTime requires that you specify a dummy sample description when you call `AddMediaSample` to add a sample to an object track). The sample itself is an atom container that contains a single object sample atom and other optional atoms.

## Object Sample Atom Structure

---

object sample atom describes a single object, including information about the default viewing angles and the view settings. The structure of an object sample atom is defined by the `QTVRObjectSampleAtom` data type:

```
typedef struct VRObjectSampleAtom {
    UInt16          majorVersion;
    UInt16          minorVersion;
    UInt16          movieType;
    UInt16          viewStateCount;
    UInt16          defaultViewState;
    UInt16          mouseDownViewState;
    UInt32          viewDuration;
    UInt32          columns;
    UInt32          rows;
    Float32         mouseMotionScale;
}
```

```

Float32          minPan;
Float32          maxPan;
Float32          defaultPan;
Float32          minTilt;
Float32          maxTilt;
Float32          defaultTilt;
Float32          minFieldOfView;
Float32          fieldOfView;
Float32          defaultFieldOfView;
Float32          defaultViewCenterH;
Float32          defaultViewCenterV;
Float32          viewRate;
Float32          frameRate;
UInt32           animationSettings;
UInt32           controlSettings;
} VRObjectSampleAtom, *VRObjectSampleAtomPtr;
QT
QT
QT

```

**Field descriptions**`majorVersion`

The major version number of the file format.

`minorVersion`

The minor version number of the file format.

`movieType`

The movie controller type.

`viewStateCount`

The number of view states of the object. A view state selects an alternate set of images for an object's views. The value of this field must be positive.

`defaultViewState`

The 1-based index of the default view state. The default view state image for a given view is displayed when the mouse button is not down.

`mouseDownViewState`

The 1-based index of the mouse-down view state. The mouse-down view state image for a given view is displayed while the user holds the mouse button down and the cursor is over an object movie.

`viewDuration`

The total movie duration of all image frames contained in an object's view. In an object that uses a single frame to represent a view, the duration is the image track's sample duration time.

`columns`

The number of columns in the object image array (that is, the number of horizontal positions or increments in the range defined by the minimum and maximum pan values). The value of this field must be positive.

`rows`

The number of rows in the object image array (that is, the number of vertical positions or increments in the range defined by the minimum and maximum tilt values). The value of this field must be positive.



`mouseMotionScale`

The mouse motion scale factor (that is, the number of degrees that an object is panned or tilted when the cursor is dragged the entire width of the VR movie image). The default value is 180.0.

`minPan`

The minimum pan angle, in degrees. The value of this field must be less than the value of the `maxPan` field.

`maxPan`

The maximum pan angle, in degrees. The value of this field must be greater than the value of the `minPan` field.

`defaultPan`

The default pan angle, in degrees. This is the pan angle used when the object is first displayed. The value of this field must be greater than or equal to the value of the `minPan` field and less than or equal to the value of the `maxPan` field.

`minTilt`

The minimum tilt angle, in degrees. The default value is +90.0. The value of this field must be less than the value of the `maxTilt` field.

`maxTilt`

The maximum tilt angle, in degrees. The default value is -90.0. The value of this field must be greater than the value of the `minTilt` field.

`defaultTilt`

The default tilt angle, in degrees. This is the tilt angle used when the object is first displayed. The value of this field must be greater than or equal to the value of the `minTilt` field and less than or equal to the value of the `maxTilt` field.

`minFieldOfView`

The minimum field of view to which the object can zoom. The valid range for this field is from 1 to the value of the `fieldOfView` field. The value of this field must be positive.

`fieldOfView`

The image field of view, in degrees, for the entire object. The value in this field must be greater than or equal to the value of the `minFieldOfView` field.

`defaultFieldOfView`

The default field of view for the object. This is the field of view used when the object is first displayed. The value in this field must be greater than or equal to the value of the `minFieldOfView` field and less than or equal to the value of the `fieldOfView` field.

`defaultViewCenterH`

The default horizontal view center.

`defaultViewCenterV`

The default vertical view center.

`viewRate`

The view rate (that is, the positive or negative rate at which the view animation in the object plays, if view animation is enabled). The value of this field must be from -100.0 through +100.0, inclusive.

frameRate

The frame rate (that is, the positive or negative rate at which the frame animation in a view plays, if frame animation is enabled). The value of this field must be from  $-100.0$  through  $+100.0$ , inclusive.

animationSettings

A set of 32-bit flags that encode information about the animation settings of the object.

controlSettings

A set of 32-bit flags that encode information about the control settings of the object.

The `movieType` field of the object sample atom structure specifies an object controller type, that is, the user interface to be used to manipulate the object.

QuickTime VR supports the following controller types:

```
enum ObjectUITypes {
    kGrabberScrollerUI           = 1,
    kOldJoyStickUI              = 2,
    kJoystickUI                  = 3,
    kGrabberUI                   = 4,
    kAbsoluteUI                  = 5
};
```

### Constant descriptions

kGrabberScrollerUI

The default controller, which displays a hand for dragging and rotation arrows when the cursor is along the edges of the object window.

kOldJoyStickUI

A joystick controller, which displays a joystick-like interface for spinning the object. With this controller, the direction of panning is reversed from the direction of the grabber.

kJoystickUI

A joystick controller, which displays a joystick-like interface for spinning the object. With this controller, the direction of panning is consistent with the direction of the grabber.

kGrabberUI

A grabber-only interface, which displays a hand for dragging but does not display rotation arrows when the cursor is along the edges of the object window.

kAbsoluteUI

An absolute controller, which displays a finger for pointing. The absolute controller switches views based on a row-and-column grid mapped into the object window.

## Animation Settings

---

The `animationSettings` field of the object sample atom is a long integer that specifies a set of animation settings for an object node. Animation settings specify characteristics of the movie while it is playing. Use these constants to specify animation settings:

```
enum QTVRAnimationSettings {
    kQTVRObjectAnimateViewFramesOn      = (1 << 0),
    kQTVRObjectPalindromeViewFramesOn  = (1 << 1),
    kQTVRObjectStartFirstViewFrameOn    = (1 << 2),
};
```

```

    kQTVRObjectAnimateViewsOn           = (1 << 3),
    kQTVRObjectPalindromeViewsOn       = (1 << 4),
    kQTVRObjectSyncViewToFrameRate     = (1 << 5),
    kQTVRObjectDontLoopViewFramesOn    = (1 << 6),
    kQTVRObjectPlayEveryViewFrameOn    = (1 << 7)
};

```

**Constant descriptions**

`kQTVRObjectAnimateViewFramesOn`

The animation setting to play all frames in the current view state.

`kQTVRObjectPalindromeViewFramesOn`

The animation setting to play a back-and-forth animation of the frames of the current view state.

`kQTVRObjectStartFirstViewFrameOn`

The animation setting to play the frame animation starting with the first frame in the view (that is, at the view start time).

`kQTVRObjectAnimateViewsOn`

The animation setting to play all views of the current object in the default row of views.

`kQTVRObjectPalindromeViewsOn`

The animation setting to play a back-and-forth animation of all views of the current object in the default row of views.

`kQTVRObjectSyncViewToFrameRate`

The animation setting to synchronize the view animation to the frame animation and use the same options as for frame animation.

`kQTVRObjectDontLoopViewFramesOn`

The animation setting to stop playing the frame animation in the current view at the end.

`kQTVRObjectPlayEveryViewFrameOn`

The animation setting to play every view frame regardless of play rate. The play rate is used to adjust the duration in which a frame appears but no frames are skipped so the rate is not exact.

**Control Settings**

The `controlSettings` field of the object sample atom is a long integer that specifies a set of control settings for an object node. Control settings specify whether the object can wrap during panning and tilting, as well as other features of the node. The control settings are specified using these bit flags:

```

enum QTVRControlSettings {
    kQTVRObjectWrapPanOn           = (1 << 0),
    kQTVRObjectWrapTiltOn         = (1 << 1),
    kQTVRObjectCanZoomOn          = (1 << 2),
    kQTVRObjectReverseHControlOn  = (1 << 3),
    kQTVRObjectReverseVControlOn  = (1 << 4),
    kQTVRObjectSwapHVControlOn    = (1 << 5),
    kQTVRObjectTranslationOn      = (1 << 6)
};

```

**Constant Descriptions**

`kQTVRObjectWrapPanOn`

The control setting to enable wrapping during panning. When this control setting is enabled, the user can wrap around from the current pan constraint maximum value to the pan constraint minimum value (or vice versa) using the mouse or arrow keys.

`kQTVRObjectWrapTiltOn`

The control setting to enable wrapping during tilting. When this control setting is enabled, the user can wrap around from the current tilt constraint maximum value to the tilt constraint minimum value (or vice versa) using the mouse or arrow keys.

`kQTVRObjectCanZoomOn`

The control setting to enable zooming. When this control setting is enabled, the user can change the current field of view using the zoom-in and zoom-out keys on the keyboard (or using the VR controller buttons).

`kQTVRObjectReverseHControlOn`

The control setting to reverse the direction of the horizontal control.

`kQTVRObjectReverseVControlOn`

The control setting to reverse the direction of the vertical control.

`kQTVRObjectSwapHVControlOn`

The control setting to exchange the horizontal and vertical controls.

`kQTVRObjectTranslationOn`

The control setting to enable translation. When this setting is enabled, the user can translate using the mouse when either the translate key is held down or the controller translation mode button is toggled on.

## Track References for Object Tracks

---

The track references to an object's image and hot spot tracks are not handled the same way as track references to panoramas. The track reference types are the same (`kQTVRImageTrackRefType` and `kQTVRHotSpotTrackRefAtomType`), but the location of the reference indexes is different. There is no entry in the object sample atom for the track reference indexes. Instead, separate atoms using the `VRTrackRefEntry` structure are stored as siblings to the object sample atom. The types of these atoms are `kQTVRImageTrackRefAtomType` and `kQTVRHotSpotTrackRefAtomType`. If either of these atoms is not present, then the reference index to the corresponding track is assumed to be 1.

**Note:** The `trackResolution` field in the `VRTrackRefEntry` structure is ignored for object tracks.

The actual views of an object for an object node are contained in an object image track, which is usually a standard QuickTime video track. (An object image track can also be any type of track that is capable of displaying an image, such as a QuickTime 3D track.)

As described in Chapter 1 of *QuickTime VR*, these views are often captured by moving a camera around the object in a defined pattern of pan and tilt angles. The views must then be ordered into an object image array, which is stored as a one-dimensional sequence of frames in the movie's video track (see [Figure 3-23](#) (page 213)).

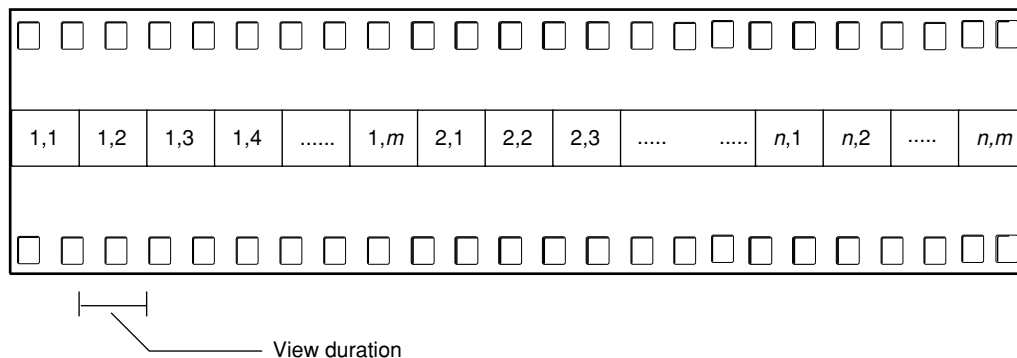
**Figure 3-23** The structure of an image track for an object

For object movies containing frame animation, each animated view in the object image array consists of the animating frames. It is not necessary that each view in the object image array contain the same number of frames, but the view duration of all views in the object movie must be the same.

For object movies containing alternate view states, alternate view states are stored as separate object image arrays that immediately follow the preceding view state in the object image track. Each state does not need to contain the same number of frames. However, the total movie time of each view state in an object node must be the same.

## Movie Media

---

Movie media is used to encapsulate embedded movies within QuickTime movies. This feature is available in QuickTime 4.1.

### Movie Sample Description

---

The movie media doesn't have a unique sample description. It uses the minimum sample description, which is `SampleDescriptionRecord`.

### Movie Media Sample Format

---

Each sample in the movie media is a QuickTime atom container. All root-level atoms and their contents are enumerated in the following list. Note that the contents of all atoms are stored in big-endian format.

#### `kMovieMediaDataReference`

A data reference type and a data reference. The data reference type is stored as an `OSType` at the start of the atom. The data reference is stored following the data reference type. If the data reference type is `URL` and the data reference is for a movie on the Apple website, the contents of the atom would be `url http://www.apple.com/foo.mov`.

There may be more than one atom of this type. The first atom of this type should have an atom ID of 1. Additional data references should be numbered sequentially.

`kMovieMediaDefaultDataReferenceID`

This atom contains a `QTAtomID` that indicates the ID of the data reference to use when instantiating the embedded movie for this sample. If this atom is not present, the data reference with an ID of 1 is used.

`kMovieMediaSlaveTime`

A Boolean that indicates whether or not the `TimeBase` of the embedded movie should be slaved to the `TimeBase` of the parent movie. If the `TimeBase` is slaved, the embedded movie's zero time will correspond to the start time of its movie media sample. Further, the playback rate of the embedded movie will always be the same as the parent movie's. If the `TimeBase` is not slaved, the embedded movie will default to a rate of 0, and a default time of whatever default time value it instantiated with (which may not be 0). If the `TimeBase` is not slaved, the embedded movie can be played by either including an `AutoPlay` atom in the movie media sample or by using a wired action. If this atom is not present, the embedded movie defaults to not slaved.

`kMovieMediaSlaveAudio`

A Boolean that indicates whether or not the audio properties of the embedded movie should be slaved to those of the parent movie. When audio is slaved, all audio properties of the containing track are duplicated in the embedded movie. These properties include sound volume, balance, bass and treble, and level metering. If this atom is not present, the embedded movie defaults to not slaved audio.

`kMovieMediaSlaveGraphicsMode`

A Boolean that indicates how the graphics mode of the containing track is applied to the embedded movie. If the graphics mode is not slaved, then the entire embedded movie is imaged using its own graphics modes. The result of the drawing of the embedded movie is composited onto the containing movie using the graphics mode of the containing track. If the graphics mode is slaved, then the graphics mode of each track in the embedded movie is ignored and instead the graphics mode of the containing track is used. In this case, the tracks of the embedded movie composite their drawing directly into the parent movie's contents. If this atom is not present, the graphics mode defaults to not slaved. Graphics mode slaving is useful for compositing semi-transparent media—for example, a PNG with an alpha channel—on top of other media.

`kMovieMediaSlaveTrackDuration`

A Boolean that indicates how the Movie Media Handler should react when the duration of the embedded movie is different than the duration of the movie media sample that it is contained by. When the movie media sample is created, the duration of the embedded movie may not yet be known. Therefore, the duration of the media sample may not be correct. In this case, the Movie Media Handler can do one of two things. If this atom is not present or it contains a value of false, the Movie Media Handler will respect the duration of media sample that contains the embedded movie. If the embedded movie has a longer duration than the movie media sample, the embedded movie will be truncated to the duration of the containing movie media sample. If the embedded movie is shorter, there will be a gap after it is finished playing. If this atom contains a value of true, the duration of the movie media sample will be adjusted to match the actual duration of the embedded movie. Because it is not possible to change an existing media sample, this will cause a new media sample to be added to the movie and the track's edit list to be updated to reference the new sample instead of the original sample.

**Note:** When the duration of the embedded movie’s sample is adjusted, by default no other tracks are adjusted. This can cause the overall temporal composition to change in unintended ways. To maintain the complete temporal composition, a higher-level data structure which describes the temporal relationships between the various tracks must also be included with the movie.

**kMovieMediaAutoPlay**

A Boolean that indicates whether or not the embedded movie should start playing immediately after being instantiated. This atom is only used if the `TimeBase` of the embedded movie is not slaved to the parent movie. See the `kMovieMediaSlaveTime` atom in “[Movie Media Sample Format](#)” (page 213) for more information. If auto play is requested, the movie will be played at its preferred rate after being instantiated. If this atom is not present, the embedded movie will not automatically play.

**kMovieMediaLoop**

A `UInt8` that indicates how the embedded movie should loop. This atom is only used if the `TimeBase` of the embedded movie is not slaved to the parent movie. See the `kMovieMediaSlaveTime` atom in “[Movie Media Sample Format](#)” (page 213) for more information. If this atom contains a 0, or if this atom is not present, the embedded movie will not loop. If this atom contains a value of 1, the embedded movie loops normally—that is, when it reaches the end it loops back to the beginning. If this atom contains a value of 2, the embedded movie uses palindromic looping. All other values are reserved.

**kMovieMediaUseMIMETYPE**

Text (not a C string or a pascal string) that indicates the MIME type of the movie import component that should be used to instantiate this media. This is useful in cases where the data reference may not contain MIME type information. If this atom is not present, the MIME type of the data reference as determined at instantiation time is used. This atom is intended to allow content creators a method for working around MIME type binding problems. It should not typically be required, and should not be included in movie media samples by default.

**kMovieMediaTitle**

Currently unused. It would contain text indicating the name of the embedded movie.

**kMovieMediaAltText**

Text (not a C string or a pascal string) that is displayed to the user when the embedded movie is being instantiated or if the embedded movie cannot be instantiated. If this atom is not present, the name of the data reference (typically the file name) is used.

**kMovieMediaClipBegin**

A `MovieMediaTimeRecord` that indicates the time of the embedded movie that should be used. The clip begin atom provides a way to specify that a portion of the beginning of the embedded movie should not be used. If this atom is not present, the beginning of the embedded movie is not changed. Note that this atom does not change the time at which the embedded movie begins playing in the parent movie’s time line. If the time specified in the clip begin atom is greater than the duration of the embedded movie, then the embedded movie will not play at all.

```
struct MovieMediaTimeRecord {
    wide           time;
    TimeScale     scale;
};
```

`kMovieMediaClipDuration`

A `MovieMediaTimeRecord` that indicates the duration of the embedded movie that should be used. The clip duration atom is applied by removing media from end of the embedded movie. If the clip duration atom is not present, then no media is removed from the end of the embedded movie. In situations where the sample contains both a clip duration and a clip begin atom, the clip begin is applied first. If the clip duration specifies a value that is larger than the duration of the embedded movie, no change is made to the embedded movie.

`kMovieMediaEnableFrameStepping`

A Boolean that indicates whether or not the embedded movie should be considered when performing step operations, specifically using the interesting time calls with the `nextTimeStep` flag. If this atom is not present or is set to `false`, the embedded movie is not included in step calculations. If the atom is set to `true`, it is included in step calculations.

`kMovieMediaBackgroundColor`

An `RGBColor` that is used for filling the background when the movie is being instantiated or when it fails to instantiate.

`kMovieMediaRegionAtom`

A number of child atoms, shown below, which describe how the Movie Media Handler should resize the embedded movie. If this atom is not present, the Movie Media Handler resizes the child movie to completely fill the containing track's box.

`kMovieMediaSpatialAdjustment`

This atom contains an `OStype` that indicates how the embedded movie should be scaled to fit the track box. If this atom is not present, the default value is `kMovieMediaFitFill`. These modes are all based on SMIL layout options.

`kMovieMediaFitClipIfNecessary`

If the media is larger than the track box, it will be clipped; if it is smaller, any additional area will be transparent.

`kMovieMediaFitFill`

The media will be scaled to completely fill the track box.

`kMovieMediaFitMeet`

The media is proportionally scaled so that it is entirely visible in the track box and fills the largest area possible without changing the aspect ratio.

`kMovieMediaFitSlice`

The media is scaled proportionally so that the smaller dimension is completely visible.

`kMovieMediaFitScroll`

Not currently implemented. It currently has the same behavior as `kMovieMediaFitClipIfNecessary`. When implemented, it will have the behavior described in the SMIL specification for a scrolling layout element.

`kMovieMediaRectangleAtom`

Four child atoms that define a rectangle. Not all child atoms must be present: top and left must both appear together, width and height must both appear together. The dimensions contained in this rectangle are used in place of the track box when applying the contents of the spatial adjustment atom. If the top and left are not specified, the top and left of the containing track's



box are used. If the width and height are not specified, the width and height of the containing track's box are used. Each child atom contains a UInt32.

kMovieMediaTop

If present, the top of the rectangle

kMovieMediaLeft

If present, the left boundary of the rectangle

kMovieMediaWidth

If present, width of rectangle

kMovieMediaHeight

If present, height of rectangle



# Basic Data Types

This chapter describes a number of common data types that are used in QuickTime files.

## Language Code Values

Some elements of a QuickTime file may be associated with a particular spoken language. To indicate the language associated with a particular object, the QuickTime file format uses either language codes from the Macintosh Script Manager or ISO language codes (as specified in *ISO 639-2/T*).

QuickTime stores language codes as unsigned 16-bit fields. All Macintosh language codes have a value that is less than 0x800. ISO language codes are three-character codes, and are stored inside the 16-bit language code field as packed arrays, as described in “[ISO Language Codes](#)” (page 222). If treated as an unsigned 16-bit integer, an ISO language code always has a value of 0x800 or greater.

If the language is specified using a Macintosh language code, any associated text uses Macintosh text encoding.

If the language is specified using an ISO language code, any associated text uses Unicode text encoding. When Unicode is used, the text is in UTF-8 unless it starts with a byte-order-mark (BOM, 0xFEFF.), whereupon the text is in UTF-16. Both the BOM and the UTF-16 text should be big-endian.

**Note:** ISO language codes cannot be used for all elements of a QuickTime file. Currently, ISO language codes can be used *only for user data text*. All other elements, including text tracks, must be specified using Macintosh language codes.

## Macintosh Language Codes

[Table 4-1](#) (page 219) lists some of the Macintosh language codes supported by QuickTime.

**Table 4-1** QuickTime language code values

Language	Value	Language	Value
English	0	Georgian	52
French	1	Moldavian	53

Language	Value	Language	Value
German	2	Kirghiz	54
Italian	3	Tajiki	55
Dutch	4	Turkmen	56
Swedish	5	Mongolian	57
Spanish	6	MongolianCyr	58
Danish	7	Pashto	59
Portuguese	8	Kurdish	60
Norwegian	9	Kashmiri	61
Hebrew	10	Sindhi	62
Japanese	11	Tibetan	63
Arabic	12	Nepali	64
Finnish	13	Sanskrit	65
Greek	14	Marathi	66
Icelandic	15	Bengali	67
Maltese	16	Assamese	68
Turkish	17	Gujarati	69
Croatian	18	Punjabi	70
Traditional Chinese	19	Oriya	71
Urdu	20	Malayalam	72
Hindi	21	Kannada	73
Thai	22	Tamil	74
Korean	23	Telugu	75
Lithuanian	24	Sinhalese	76
Polish	25	Burmese	77
Hungarian	26	Khmer	78
Estonian	27	Lao	79
Lettish	28	Vietnamese	80
Latvian	28	Indonesian	81

Language	Value	Language	Value
Saamish	29	Tagalog	82
Lappish	29	MalayRoman	83
Faeroese	30	MalayArabic	84
Farsi	31	Amharic	85
Russian	32	Galla	87
Simplified Chinese	33	Oromo	87
Flemish	34	Somali	88
Irish	35	Swahili	89
Albanian	36	Ruanda	90
Romanian	37	Rundi	91
Czech	38	Chewa	92
Slovak	39	Malagasy	93
Slovenian	40	Esperanto	94
Yiddish	41	Welsh	128
Serbian	42	Basque	129
Macedonian	43	Catalan	130
Bulgarian	44	Latin	131
Ukrainian	45	Quechua	132
Byelorussian	46	Guarani	133
Uzbek	47	Aymara	134
Kazakh	48	Tatar	135
Azerbaijani	49	Uighur	136
AzerbaijanAr	50	Dzongkha	137
Armenian	51	JavaneseRom	138

## ISO Language Codes

---

Because the language codes specified by ISO 639-2/T are three characters long, they must be packed to fit into a 16-bit field. The packing algorithm must map each of the three characters, which are always lowercase, into a 5-bit integer and then concatenate these integers into the least significant 15 bits of a 16-bit integer, leaving the 16-bit integer's most significant bit set to zero.

One algorithm for performing this packing is to treat each ISO character as a 16-bit integer. Subtract 0x60 from the first character and multiply by 2<sup>10</sup> (0x400), subtract 0x60 from the second character and multiply by 2<sup>5</sup> (0x20), subtract 0x60 from the third character, and add the three 16-bit values. This will result in a single 16-bit value with the three codes correctly packed into the 15 least significant bits and the most significant bit set to zero.

Example: The ISO language code 'jpn' consists of the three hexadecimal values 0x6A, 0x70, 0x6E. Subtracting 0x60 from each value yields the values 0xA, 0x10, 0xE, as shown in the following table.

**Table 4-2** 5-bit values of UTF-8 characters

Character	UTF-8 code	5-bit value	Shifted value
j	0x6A	0xA (01010)	0x2800 (01010.....)
p	0x70	0x10 (10000)	0x200 (.....10000.....)
n	0x6E	0xE (01110)	0xE (.....01110)

The first value is shifted 10 bits to the left (multiplied by 0x400) and the second value is shifted 5 bits to the left (multiplied by 0x20). This yields the values 0x2800, 0x200, 0xE. When added, this results in the 16-bit packed language code value of 0x2A0E.

## Calendar Date and Time Values

---

QuickTime movies store date and time information in Macintosh date format: a 32-bit value indicating the number of seconds that have passed since midnight January 1, 1904.

This value does not specify a time zone. Common practice is to use local time for the time zone where the value is generated.

It is strongly recommended that all calendar date and time values be stored using UTC time, so that all files have a time and date relative to the same time zone.

## Matrices

---

QuickTime files use matrices to describe spatial information about many objects, such as tracks within a movie.

A transformation matrix defines how to map points from one coordinate space into another coordinate space. By modifying the contents of a transformation matrix, you can perform several standard graphics display operations, including translation, rotation, and scaling. The matrix used to accomplish two-dimensional transformations is described mathematically by a 3-by-3 matrix.

All values in the matrix are 32-bit fixed-point numbers divided as 16.16, except for the {u, v, w} column, which contains 32-bit fixed-point numbers divided as 2.30. [Figure 4-1](#) (page 223) depicts how QuickTime uses matrices to transform displayed objects.

**Figure 4-1** How display matrices are used in QuickTime

$$\begin{bmatrix} x & y & 1 \end{bmatrix} \times \begin{bmatrix} a & b & u \\ c & d & v \\ t_x & t_y & w \end{bmatrix} = \begin{bmatrix} x' & y' & 1 \end{bmatrix}$$

**Figure 4-2** Applying the transform

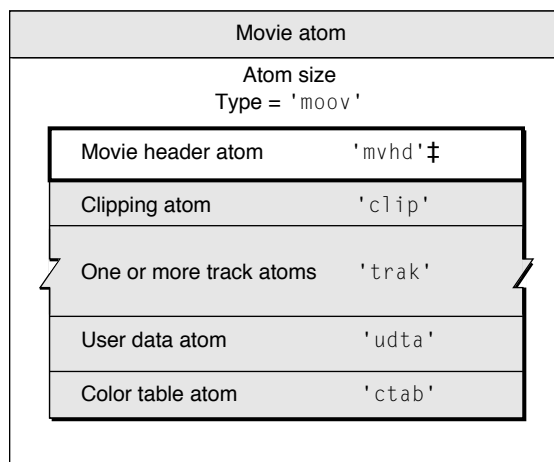

‡ Required atom

## Graphics Modes

QuickTime files use graphics modes to describe how one video or graphics layer should be combined with the layers beneath it. Graphics modes are also known as transfer modes. Some graphics modes require a color to be specified for certain operations, such as blending to determine the blend level. QuickTime uses the graphics modes defined by Apple’s QuickDraw.

The most common graphics modes are `and` and `ditherCopy`, which simply indicate that the image should not blend with the image behind it, but overwrite it. QuickTime also defines several additional graphics modes.

[Table 4-3](#) (page 224) lists the additional graphics modes supported by QuickTime.

**Table 4-3** QuickTime graphics modes

Mode	Uses opcolor	Code	Description
Copy		0x0	Copy the source image over the destination.
Dither copy		0x40	Dither the image (if needed), otherwise do a copy.
Blend	yes	0x20	Replaces destination pixel with a blend of the source and destination pixel colors, with the proportion for each channel controlled by that channel in the opcolor.
Transparent	yes	0x24	Replaces the destination pixel with the source pixel if the source pixel isn't equal to the opcolor.
Straight alpha		0x100	Replaces the destination pixel with a blend of the source and destination pixels, with the proportion controlled by the alpha channel.
Premul white alpha		0x101	Premultiplied with white means that the color components of each pixel have already been blended with a white pixel, based on their alpha channel value. Effectively, this means that the image has already been combined with a white background. First, remove the white from each pixel and then blend the image with the actual background pixels.
Premul black alpha		0x102	Premultiplied with black is the same as pre-multiplied with white, except the background color that the image has been blended with is black instead of white.
Straight alpha blend	yes	0x104	Similar to straight alpha, but the alpha value used for each channel is the combination of the alpha channel and that channel in the opcolor.
Composition (dither copy)		0x103	(Tracks only) The track is drawn offscreen, and then composed onto the screen using dither copy

## RGB Colors

---

Many atoms in the QuickTime file format contain RGB color values. These are usually stored as three consecutive unsigned 16-bit integers in the following order: red, green, blue.

## Balance

---

Balance values are represented as 16-bit, fixed-point numbers that range from -1.0 to +1.0. The high-order 8 bits contain the integer portion of the value; the low-order 8 bits contain the fractional part. Negative values weight the balance toward the left speaker; positive values emphasize the right channel. Setting the balance to 0 corresponds to a neutral setting.



# Some Useful Examples and Scenarios

---

This chapter contains a number of examples that can help you pull together all of the material in this book by examining the atom structure that results from a number of different scenarios.

The chapter is divided into the following topics:

- [“Creating, Copying, and Disposing of Atom Containers”](#) (page 226) discusses the various ways you can work with atom containers, along with illustrations and sample code that show usage.
- [“Creating an Effect Description”](#) (page 233) discusses how you create an effect description by creating an atom container, inserting a QT atom that specifies the effect, and inserting a set of QT atoms that set its parameters.
- [“Creating Movies With Modifier Tracks”](#) (page 238) provides sample code showing you how to create a movie with modifier tracks.
- [“Authoring Movies With External Movie Targets”](#) (page 239) discusses how to author movies with external targets, using two new target atoms introduced in QuickTime 4.
- [“Adding Wired Actions To a Flash Track”](#) (page 240) explains the steps you need to follow in order to add wired actions to a Macromedia Flash track.
- [“Creating Video Tracks at 30 Frames-per-Second”](#) (page 243) discusses creating 30 fps video.
- [“Creating Video Tracks at 29.97 Frames-per-Second”](#) (page 243) describes creating 29.97 fps video.
- [“Creating Audio Tracks at 44.1 Khz”](#) (page 244) provides an example of creating an audio track.
- [“Creating a Timecode Track for 29.97 FPS Video”](#) (page 244) presents a timecode track example.
- [“Playing With Edit Lists”](#) (page 248) discusses how to interpret edit list data.
- [“Interleaving Movie Data”](#) (page 250) shows how a movie’s tracks are interleaved in the movie data file.
- [“Referencing Two Data Files With a Single Track”](#) (page 251) shows how track data may reside in more than one file.
- [“Getting the Name of a QuickTime VR Node”](#) (page 252) discusses how you can use standard QuickTime atom container functions to retrieve the information in a QuickTime VR node header atom.
- [“Adding Custom Atoms in a QuickTime VR Movie”](#) (page 254) describes how to add custom atoms to either the QuickTime VR world or node information atom containers.
- [“Adding Atom Containers in a QuickTime VR Movie”](#) (page 255) shows the code you would use to add VR world and node information atom containers to a QTVR track.

- “[Optimizing QuickTime VR Movies for Web Playback](#)” (page 256) describes how to use the QTVR Flattener, a movie export component that converts an existing QuickTime VR single node movie into a new movie that is optimized for viewing on the Web.

## Creating, Copying, and Disposing of Atom Containers

---

Before you can add atoms to an atom container, you must first create the container by calling `QTNewAtomContainer`. The code sample shown in [Listing 5-1](#) (page 226) calls `QTNewAtomContainer` to create an atom container.

### Listing 5-1 Creating a new atom container

```
QTAtomContainer spriteData;
OSError err
// create an atom container to hold a sprite's data
err=QTNewAtomContainer (&spriteData);
```

When you have finished using an atom container, you should dispose of it by calling the `QTDisposeAtomContainer` function. The sample code shown in [Listing 5-2](#) (page 226) calls `QTDisposeAtomContainer` to dispose of the `spriteData` atom container.

### Listing 5-2 Disposing of an atom container

```
if (spriteData)
    QTDisposeAtomContainer (spriteData);
```

## Creating New Atoms

---

You can use the `QTInsertChild` function to create new atoms and insert them in a QT atom container. The `QTInsertChild` function creates a new child atom for a parent atom. The caller specifies an atom type and atom ID for the new atom. If you specify a value of 0 for the atom ID, `QTInsertChild` assigns a unique ID to the atom.

`QTInsertChild` inserts the atom in the parent’s child list at the index specified by the `index` parameter; any existing atoms at the same index or greater are moved toward the end of the child list. If you specify a value of 0 for the `index` parameter, `QTInsertChild` inserts the atom at the end of the child list.

The code sample in [Listing 5-3](#) (page 226) creates a new QT atom container and calls `QTInsertChild` to add an atom. The resulting QT atom container is shown in [Figure 5-1](#) (page 227). The offset value 10 is returned in the `firstAtom` parameter.

### Listing 5-3 Creating a new QT atom container and calling `QTInsertChild` to add an atom.

```
QTAtom firstAtom;
QTAtomContainer container;
OSError err
err = QTNewAtomContainer (&container);
if (!err)
    err = QTInsertChild (container, kParentAtomIsContainer, 'abcd',
```

```
1000, 1, 0, nil, &firstAtom);
```

**Figure 5-1** QT atom container after inserting an atom

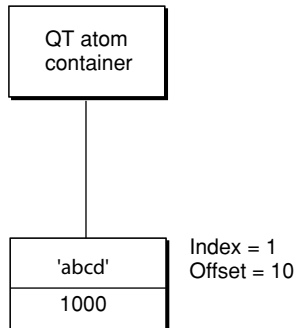

The following code sample calls `QTInsertChild` to create a second child atom. Because a value of 1 is specified for the `index` parameter, the second atom is inserted in front of the first atom in the child list; the index of the first atom is changed to 2. The resulting QT atom container is shown in [Figure 5-2](#) (page 227).

```
QTAtom secondAtom;

FailOSErr (QTInsertChild (container, kParentAtomIsContainer, 'abcd',
    2000, 1, 0, nil, &secondAtom));
```

**Figure 5-2** QT atom container after inserting a second atom

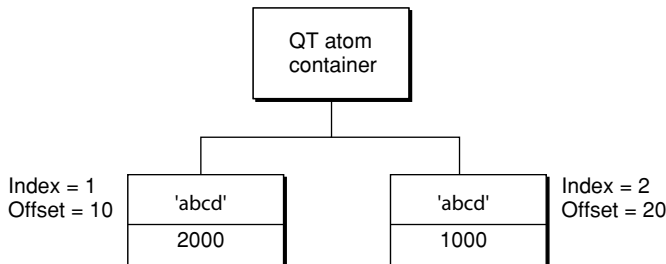

You can call the `QTFindChildByID` function to retrieve the changed offset of the first atom that was inserted, as shown in the following example. In this example, the `QTFindChildByID` function returns an offset of 20.

```
firstAtom = QTFindChildByID (container, kParentAtomIsContainer, 'abcd',
    1000, nil);
```

[Listing 5-4](#) (page 227) shows how the `QTInsertChild` function inserts a leaf atom into the atom container `sprite`. The new leaf atom contains a `sprite image index` as its data.

**Listing 5-4** Inserting a child atom

```
if ((propertyAtom = QTFindChildByIndex (sprite, kParentAtomIsContainer,
    kSpritePropertyImageIndex, 1, nil)) == 0)

    FailOSErr (QTInsertChild (sprite, kParentAtomIsContainer,
```

```
kSpritePropertyImageIndex, 1, 1, sizeof(short), &imageIndex,  
nil));
```

## Copying Existing Atoms

---

QuickTime provides several functions for copying existing atoms within an atom container. The `QTInsertChildren` function inserts a container of atoms as children of a parent atom in another atom container. [Figure 5-3](#) (page 228) shows two example QT atom containers, A and B.

**Figure 5-3** Two QT atom containers, A and B

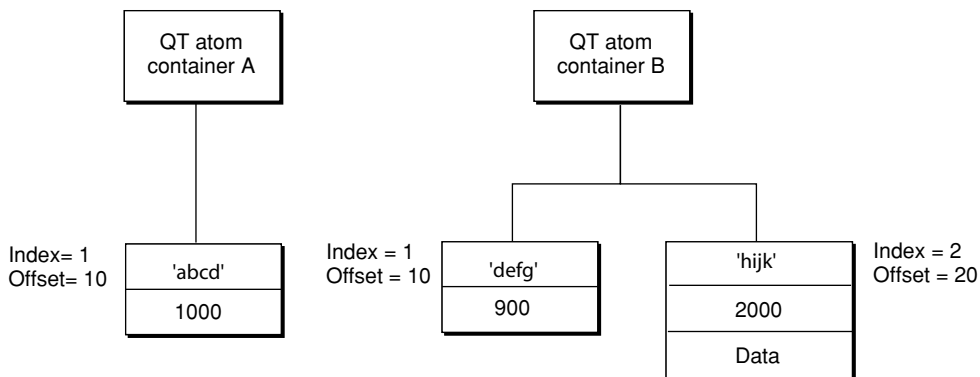

The following code sample calls `QTFindChildByID` to retrieve the offset of the atom in container A. Then, the code sample calls the `QTInsertChildren` function to insert the atoms in container B as children of the atom in container A. [Figure 5-4](#) (page 229) shows what container A looks like after the atoms from container B have been inserted.

```
QTAtom targetAtom;  
  
targetAtom = QTFindChildByID (containerA, kParentAtomIsContainer, 'abcd',  
    1000, nil);  
  
FailOSErr (QTInsertChildren (containerA, targetAtom, containerB));
```

**Figure 5-4** QT atom container after child atoms have been inserted

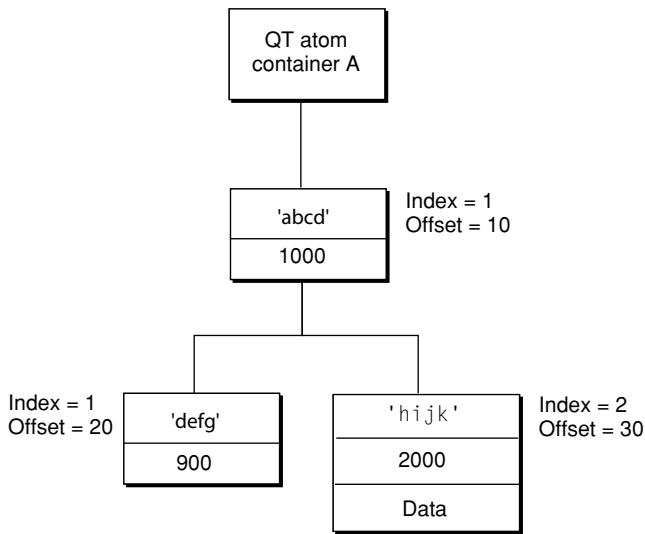

In [Listing 5-5](#) (page 229), the `QTInsertChild` function inserts a parent atom into the atom container `theSample`. Then, the code calls `QTInsertChildren` to insert the container `theSprite` into the container `theSample`. The parent atom is `newSpriteAtom`.

**Listing 5-5** Inserting a container into another container

```
FailOSErr (QTInsertChild (theSample, kParentAtomIsContainer,  
    kSpriteAtomType, spriteID, 0, 0, nil, &newSpriteAtom));  
  
FailOSErr (QTInsertChildren (theSample, newSpriteAtom, theSprite));
```

QuickTime provides three other functions you can use to manipulate atoms in an atom container. The `QTReplaceAtom` function replaces an atom and its children with a different atom and its children. You can call the `QTSwapAtoms` function to swap the contents of two atoms in an atom container; after swapping, the ID and index of each atom remains the same. The `QTCopyAtom` function copies an atom and its children to a new atom container.

## Retrieving Atoms From an Atom Container

---

QuickTime provides functions you can use to retrieve information about the types of a parent atom's children, to search for a specific atom, and to retrieve a leaf atom's data.

You can use the `QTCountChildrenOfType` and `QTGetNextChildType` functions to retrieve information about the types of an atom's children. The `QTCountChildrenOfType` function returns the number of children of a given atom type for a parent atom. The `QTGetNextChildType` function returns the next atom type in the child list of a parent atom.

You can use the `QTFindChildByIndex`, `QTFindChildByID`, and `QTNextChildAnyType` functions to retrieve an atom. You call the `QTFindChildByIndex` function to search for and retrieve a parent atom's child by its type and index within that type.

**Listing 5-6** (page 230) shows the sample code function `SetSpriteData`, which updates an atom container that describes a sprite. (For more information about sprites and the Sprite Toolbox, refer to the book *Programming With Wired Movies and Sprite Animation*, available at <http://developer.apple.com/techpubs/quicktime/qtdevdocs/RM/PDF.htm>.) For each property of the sprite that needs to be updated, `SetSpriteData` calls `QTFindChildByIndex` to retrieve the appropriate atom from the atom container. If the atom is found, `SetSpriteData` calls `QTSetAtomData` to replace the atom's data with the new value of the property. If the atom is not found, `SetSpriteData` calls `QTInsertChild` to add a new atom for the property.

**Listing 5-6** Finding a child atom by index

```
OSErr SetSpriteData (QTAtomContainer sprite, Point *location,
    short *visible, short *layer, short *imageIndex)
{
    OSErr err = noErr;
    QTAtom propertyAtom;

    // if the sprite's visible property has a new value
    if (visible)
    {
        // retrieve the atom for the visible property --
        // if none exists, insert one
        if ((propertyAtom = QTFindChildByIndex (sprite,
            kParentAtomIsContainer, kSpritePropertyVisible, 1,
            nil)) == 0)
            FailOSErr (QTInsertChild (sprite, kParentAtomIsContainer,
                kSpritePropertyVisible, 1, 1, sizeof(short), visible,
                nil))

        // if an atom does exist, update its data
        else
            FailOSErr (QTSetAtomData (sprite, propertyAtom,
                sizeof(short), visible));
    }

    // ...
    // handle other sprite properties
    // ...
}
```

You can call the `QTFindChildByID` function to search for and retrieve a parent atom's child by its type and ID. The sample code function `AddSpriteToSample`, shown in **Listing 5-7** (page 230), adds a sprite, represented by an atom container, to a key sample, represented by another atom container. `AddSpriteToSample` calls `QTFindChildByID` to determine whether the atom container `theSample` contains an atom of type `kSpriteAtomType` with the ID `spriteID`. If not, `AddSpriteToSample` calls `QTInsertChild` to insert an atom with that type and ID. A value of 0 is passed for the `index` parameter to indicate that the atom should be inserted at the end of the child list. A value of 0 is passed for the `dataSize` parameter to indicate that the atom does not have any data. Then, `AddSpriteToSample` calls `QTInsertChildren` to insert the atoms in the container `theSprite` as children of the new atom. `FailIf` and `FailOSErr` are macros that exit the current function when an error occurs.

**Listing 5-7** Finding a child atom by ID

```
OSErr AddSpriteToSample (QTAtomContainer theSample,
    QTAtomContainer theSprite, short spriteID)
{
```

```

OSErr err = noErr;
QTAtom newSpriteAtom;

FailIf (QTFindChildByID (theSample, kParentAtomIsContainer,
    kSpriteAtomType, spriteID, nil), paramErr);

FailOSErr (QTInsertChild (theSample, kParentAtomIsContainer,
    kSpriteAtomType, spriteID, 0, 0, nil, &newSpriteAtom));
FailOSErr (QTInsertChildren (theSample, newSpriteAtom, theSprite));
}

```

Once you have retrieved a child atom, you can call `QTNextChildAnyType` function to retrieve subsequent children of a parent atom. `QTNextChildAnyType` returns an offset to the next atom of any type in a parent atom's child list. This function is useful for iterating through a parent atom's children quickly.

QuickTime also provides functions for retrieving an atom's type, ID, and data. You can call `QTGetAtomTypeAndID` function to retrieve an atom's type and ID. You can access an atom's data in one of three ways.

- To copy an atom's data to a handle, you can use the `QTCopyAtomDataToHandle` function.
- To copy an atom's data to a pointer, you can use the `QTCopyAtomDataToPtr` function.
- To access an atom's data directly, you should lock the atom container in memory by calling `QTLockContainer`. Once the container is locked, you can call `QTGetAtomDataPtr` to retrieve a pointer to an atom's data. When you have finished accessing the atom's data, you should call the `QTUnlockContainer` function to unlock the container in memory.

## Modifying Atoms

---

QuickTime provides functions that you can call to modify attributes or data associated with an atom in an atom container. To modify an atom's ID, you call the function `QTSetAtomID`.

You use the `QTSetAtomData` function to update the data associated with a leaf atom in an atom container. The `QTSetAtomData` function replaces a leaf atom's data with new data. The code sample in [Listing 5-8](#) (page 231) calls

`QTFindChildByIndex` to determine whether an atom container contains a sprite's visible property. If so, the sample calls `QTSetAtomData` to replace the atom's data with a new visible property.

### Listing 5-8 Modifying an atom's data

```

QTAtom propertyAtom;

// if the atom isn't in the container, add it
if ((propertyAtom = QTFindChildByIndex (sprite, kParentAtomIsContainer,
    kSpritePropertyVisible, 1, nil)) == 0)
    FailOSErr (QTInsertChild (sprite, kParentAtomIsContainer,
        kSpritePropertyVisible, 1, 0, sizeof(short), visible, nil))

// if the atom is in the container, replace its data
else
    FailOSErr (QTSetAtomData (sprite, propertyAtom, sizeof(short),
        visible));

```

## Removing Atoms From an Atom Container

---

To remove atoms from an atom container, you can use the `QTRemoveAtom` and `QTRemoveChildren` functions. The `QTRemoveAtom` function removes an atom and its children, if any, from a container. The `QTRemoveChildren` function removes an atom's children from a container, but does not remove the atom itself. You can also use `QTRemoveChildren` to remove all the atoms in an atom container. To do so, you should pass the constant `kParentAtomIsContainer` for the `atom` parameter.

The code sample shown in [Listing 5-9](#) (page 232) adds override samples to a sprite track to animate the sprites in the sprite track. The `sample` and `spriteData` variables are atom containers. The `spriteData` atom container contains atoms that describe a single sprite. The `sample` atom container contains atoms that describes an override sample.

Each iteration of the `for` loop calls `QTRemoveChildren` to remove all atoms from both the `sample` and the `spriteData` containers. The `sample` code updates the index of the image to be used for the sprite and the sprite's location and calls `SetSpriteData` ([Listing 5-6](#) (page 230)), which adds the appropriate atoms to the `spriteData` atom container. Then, the `sample` code calls `AddSpriteToSample` ([Listing 5-7](#) (page 230)) to add the `spriteData` atom container to the `sample` atom container. Finally, when all the sprites have been updated, the `sample` code calls `AddSpriteSampleToMedia` to add the override sample to the sprite track.

### Listing 5-9 Removing atoms from a container

```
QTAtomContainer sample, spriteData;

// ...
// add the sprite key sample
// ...

// add override samples to make the sprites spin and move
for (i = 1; i <= kNumOverrideSamples; i++)
{
    QTRemoveChildren (sample, kParentAtomIsContainer);
    QTRemoveChildren (spriteData, kParentAtomIsContainer);

    // ...
    // update the sprite:
    // - update the imageIndex
    // - update the location
    // ...

    // add atoms to spriteData atom container
    SetSpriteData (spriteData, &location, nil, nil, &imageIndex);

    // add the spriteData atom container to sample
    err = AddSpriteToSample (sample, spriteData, 2);

    // ...
    // update other sprites
    // ...

    // add the sample to the media
    err = AddSpriteSampleToMedia (newMedia, sample,
        kSpriteMediaFrameDuration, false);
}
```



## Creating an Effect Description

---

An effect description tells QuickTime which effect to execute and contains the parameters that control how the effect behaves at runtime. You create an effect description by creating an atom container, inserting a QT atom that specifies the effect, and inserting a set of QT atoms that set its parameters.

There are support functions you can call to assist you in this process.

`QTCreateStandardParameterDialog` returns a complete effect description that you can use, including user-selected settings; you only need to add `kEffectSourceName` atoms to the description for effects that require sources. At a lower level, `QTGetEffectsList` returns a list of the available effects and `ImageCodecGetParameterList` will return a description of the parameters for an effect, including the default value for each parameter in the form of a QT atom that can be inserted directly into an effect description.

### Structure of an Effect Description

---

An effect description is the sole media sample for an effect track. An effect description is implemented as a `QTAtomContainer` structure, the general QuickTime structure for holding a set of QuickTime atoms. All effect descriptions must contain the set of required atoms, which specify attributes such as which effect component to use. In addition, effect descriptions can contain a variable number of parameter atoms, which hold the values of the parameters for the effect.

Each atom contains either data or a set of child atoms. If a parameter atom contains data, the data is the value of the parameter, and this value remains constant while the effect executes. If a parameter atom contains a set of child atoms, they typically contain a tween entry so the value of the parameter will be interpolated for the duration of the effect.

You assemble an effect description by adding the appropriate set of atoms to a `QTAtomContainer` structure.

You can find out what the appropriate atoms are by making an `ImageCodecGetParameterList` call to the effect component. This fills an atom container with a set of parameter description atoms. These atoms contain descriptions of the effect parameters, such as each parameter's atom type, data range, default value, and so on. The default value in each description atom is itself a `QTAtom` that can be inserted directly into your effect description.

You can modify the data in the parameter atoms directly, or let the user set them by calling `QTCreateStandardParameterDialog`, which returns a complete effect description (you need to add `kEffectSourceName` atoms for effects that require sources).

You then add the effect description to the media of the effect track.

### Required Atoms of an Effects Description

---

There are several required atoms that an effect description must contain. The first is the `kParameterWhatName` atom. The `kParameterWhatName` atom contains the name of the effect. This specifies which of the available effects to use.

The code snippet shown in [Listing 5-10](#) (page 234) adds a `kParameterWhatName` atom to the atom container `effectDescription`. The constant `kCrossFadeTransitionType` contains the name of the cross-fade effect.

**Listing 5-10** Adding a `kParameterWhatName` atom to the atom container `effectDescription`

```
effectCode = kCrossFadeTransitionType;
QTInsertChild(effectDescription, kParentAtomIsContainer,
              kParameterWhatName, kParameterWhatID, 0,
              sizeof(effectCode), &effectCode, nil);
```

In addition to the `kParameterWhatName` atom, the effect description for an effect that uses sources must contain one or more `kEffectSourceName` atoms. Each of these atoms contains the name of one of the effect's sources. An input map is used to map these names to the actual tracks of the movie that are the sources. [“Creating an Input Map”](#) (page 235) describes how to create the input map.

## Parameter Atoms of an Effects Description

---

In addition to the required atoms, the effects description contains a variable number of parameter atoms. The number and types of parameter atoms vary from effect to effect. For example, the cross fade effect has only one parameter, while the general convolution filter effect has nine. Some effects have no parameters at all, and do not require any parameter atoms.

You can obtain the list of parameter atoms for a given effect by calling the effect component using `ImageCodecGetParameterList`. The parameter description atoms it returns include default settings for each parameter in the form of parameter atoms that you can insert into your effect description.

The `QTInsertChild` function is used to add these parameters to the effect description, as seen in the code example in [Listing 5-10](#) (page 234).

Consider, for instance, the push effect. Its effect description contains a `kParameterWhatName` atom, two `kEffectSourceName` atoms, and two parameter atoms, one of which is a tween.

The `kParameterWhatName` atom specifies that this is a 'push' effect.

The two `kEffectSourceName` atoms specify the two sources that this effect will use, in this case 'srcA' and 'srcB'. The names correspond to entries in the effect track's input map.

The 'pcent' parameter atom defines which frames of the effect are shown. This parameter contains a tween entry, so that the value of this parameter is interpolated as the effect runs. The interpolation of the 'pcent' parameter causes consecutive frames of the effect to be rendered, creating the push effect.

The 'from' parameter determines the direction of the push. This parameter is set from an enumeration list, with 2 being defined as the bottom of the screen.

In this example, the source 'srcB' will push in from the bottom, covering the source 'srcA'.

The 'pcent' parameter is normally tweened from 0 to 100, so that the effect renders completely, from 0 to 100 percent. In this example, the 'pcent' parameter is tweened from 25 to 75, so the effect will start 25% of the way through (with 'srcB' already partly on screen) and finish 75% of the way through (with part of 'srcA' still visible).

[Figure 5-5](#) (page 235) shows the set of atoms that must be added to the entry description.

**Figure 5-5** An example effect description for the Push effect

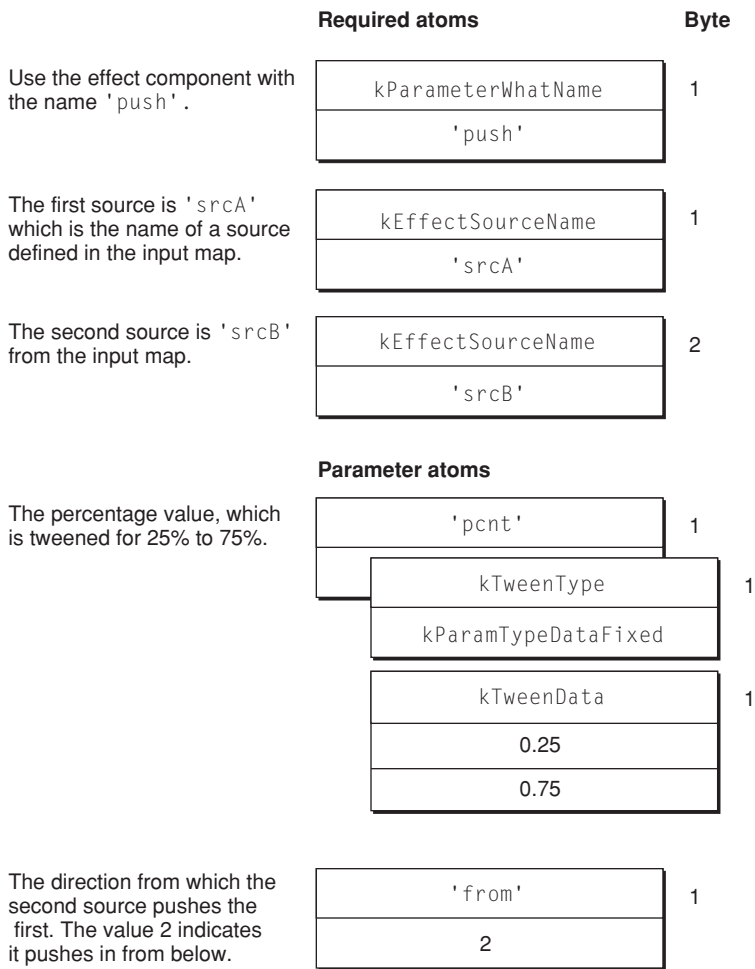

An important property of effect parameters is that most can be tweened (and some must be tweened). Tweening is QuickTime's general purpose interpolation mechanism (see "Tween Media" (page 153) for more information). For many parameters, it is desirable to allow the value of the parameter to change as the effect executes. In the example shown in Figure 5-5 (page 235), the 'pcnt' parameter must be a tween. This parameter controls which frame of the effect is rendered at any given time, so it must change for the effect to progress. The 'from' parameter is not a tween in the example above, but it could be if we wanted the direction of the push to change during the course of the effect.

## Creating an Input Map

---

The input map is another QT atom container that you attach to the effects track. It describes the sources used in the effect and gives a name to each source. This name is used to refer to the source in the effects description.

An input map works in concert with track reference atoms in the source tracks. A track reference atom of type `kTrackModifierReference` is added to each source track, which causes that source track's output to be redirected to the effects track. An input map is added to the effects track to identify the source tracks and give a name to each source, such as `'srcA'` and `'srcB'`. The effect can then refer to the sources by name, specifying that `'srcB'` should slide in over `'srcA'`, for example.

## Structure of an Input Map

---

The input map contains a set of atoms that refer to the tracks used as sources for the effect. Each source track is represented by one track reference atom of type `kTrackModifierInput`.

Each modifier input atom contains two children, one of type `kEffectDataSourceType`, and one of type `kTrackModifierType`, which hold the name and type of the source.

The name of the source is a unique identifier that you create, which is used in the effect description to reference the track. Any four-character name is valid, as long as it is unique in the set of source names.

**Important:** Apple recommends you adopt the standard naming convention `'srcX'`, where X is a letter of the alphabet. Thus, your first source would be named `'srcA'`, the second `'srcB'`, and so forth. This convention is used here in this chapter.

The child atom of type `kTrackModifierType` indicates the type of the track being referenced. For a video track the type is `VideoMediaType`, for a sprite track it is `SpriteMediaType`, and so forth. Video tracks are the most common track type used as sources for effects. Only tracks that have a visible output, such as video and sprite tracks, can be used as sources for an effect. This means, for example, that sound tracks cannot be sources for an effect.

[Figure 5-6](#) (page 237) shows a completed input map that references two sources. The first source is a video track and is called `'srcA'`. The second source, also a video track, is called `'srcB'`.

You refer to a `kTrackModifierInput` atom by its index number, which is returned by the `AddTrackReference` function when you create the atom.

**Figure 5-6** An example of an input map referencing two sources

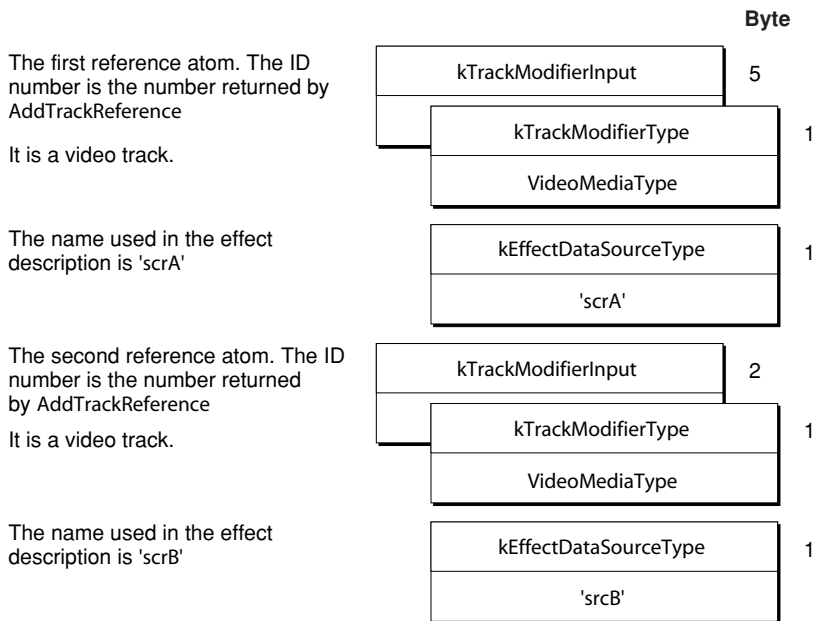

## Building Input Maps

The first step in creating an input map is to create a new `QTAtomContainer` to hold the map. You use the standard QuickTime container creation function.

```
QTNewAtomContainer(&inputMap);
```

For each source you are creating, you need to call the `AddTrackReference` function. The track IDs of the effects track and the source track are passed as parameters to `AddTrackReference`, which creates an atom of type `kTrackModifierReference` and returns an index number. You use this index as the ID of the atom when you need to refer to it. You then insert the reference into the input map as an atom of type `kTrackModifierInput`.

The code in [Listing 5-11](#) (page 237) creates a reference to the track `firstSourceTrack`, and adds it to the input map.

**Listing 5-11** Adding an input reference atom to an input map

```
AddTrackReference(theEffectsTrack, firstSourceTrack,
                  kTrackModifierReference, &referenceIndex);

QTInsertChild(inputMap, kParentAtomIsContainer,
              kTrackModifierInput, referenceIndex, 0, 0, nil, &inputAtom);
```

The `QTInsertChild` function returns the offset of the new modifier input atom in the `inputAtom` parameter.

You now need to add the name and type of the source track to the modifier input atom. Again, calling the `QTInsertChild` function does this, as shown in the following code snippet:

```
inputType = VideoMediaType;
QTInsertChild(inputMap, inputAtom,
```

```

        kTrackModifierType, 1, 0, sizeof(inputType), &inputType,
        nil);

aType = 'srcA';
QTInsertChild(inputMap, inputAtom, kEffectDataSourceType, 1, 0,
              sizeof(aType), &aType, nil);

```

This process is repeated for each source for the effect.

## Creating Movies with Modifier Tracks

---

QuickTime 2.1 added additional functionality for media handlers. By way of modifier tracks, a media handler can send its data to another media handler rather than presenting its media directly. See [“Modifier Tracks”](#) (page 163) for a complete discussion of this feature.

To create a movie with modifier tracks, first you create a movie with all the desired tracks, then you create the modifier track. To link the modifier track to the track that it modifies, you use the `AddTrackReference` function as shown in [Listing 5-12](#) (page 238).

### Listing 5-12 Linking a modifier track to the track it modifies

```

long addedIndex;
AddTrackReference(aVideoTrack, aModifierTrack,
                 kTrackModifierReference, &addedIndex);

```

The reference doesn’t completely describe the modifier track’s relationship to the track it modifies. Instead, the reference simply tells the modifier track to send its data to the specified track. The receiving track doesn’t “know” what it should do with that data. A single track may also be receiving data from more than one modifier track.

To describe how each modifier input should be used, each track’s media also has an input map. The media’s input map describes how the data being sent to each input of a track should be interpreted by the receiving track. After creating the reference, it is necessary to update the receiving track’s media input map. When `AddTrackReference` is called, it returns the index of the reference added. That index is the index of the input that needs to be described in the media input map. If the modifier track created above contains regions to change the shape of the video track, the code shown in [Listing 5-13](#) (page 238) updates the input map appropriately.

### Listing 5-13 Updating the input map

```

QTAtomContainer inputMap;
QTAtom inputAtom;
OSType inputType;

Media aVideoMedia = GetTrackMedia(aVideoTrack);
GetMediaInputMap (aVideoMedia, &inputMap);

QTInsertChild(inputMap, kParentAtomIsContainer, kTrackModifierInput,
              addedIndex, 0,0, nil, &inputAtom);

inputType = kTrackModifierTypeClip;
QTInsertChild (inputMap, inputAtom, kTrackModifierType, 1, 0,

```

```

        sizeof(inputType), &inputType, nil);

SetMediaInputMap(aVideoMedia, inputMap);
QTDisposeAtomContainer(inputMap);

```

The media input map allows you to store additional information for each input. In the preceding example, only the type of the input is specified. In other types of references, you may need to specify additional data.

When a modifier track is playing an empty track edit, or is disabled or deleted, all receiving tracks are notified that the track input is inactive. When an input becomes inactive, it is reset to its default value. For example, if a track is receiving data from a clip modifier track and that input becomes inactive, the shape of the track reverts to the shape it would have if there were no clip modifier track.

## Authoring Movies with External Movie Targets

---

QuickTime 4 enables you to author movies with external movie targets. To specify an action that targets an element of an external movie, you must identify the external movie by either its name or its ID. Two new target atom types have been introduced for this purpose; these atoms are used in addition to the existing target atoms, which you may use to specify that the element is a particular track or object within a track, such as a sprite.

**Note:** A movie ID may be specified by an expression.

These additional target atoms provided in QuickTime 4:

```

[(ActionTargetAtoms)] =
    <kActionTarget>

        <kTargetMovieName>
            [Pstring MovieName]
        OR
        <kTargetMovieID>
            [long MovieID]
            OR
            [(kExpressionAtoms)]

```

To tag a movie with a name or ID, you add a user data item of type 'plug' to the movie's user data. The index of the user data does not matter. The data specifies the name or ID.

You add a user data item of type 'plug' to the movie's user data with its data set to

```
"Movieid=MovieName"
```

where `MovieName` is the name of the movie.

You add a user data item of type 'plug' to the movie's user data with its data set to

```
"Movieid=MovieID"
```

where the ID is a signed long integer.

The QuickTime plug-in additionally supports `EMBED` tag parameters, which allow you to override a movie's name or ID within an HTML page.

## Target Atoms for Embedded Movies

---

QuickTime 4.1 introduced target atoms to accommodate the addition of embedded movies. These target atoms allow for paths to be specified in a hierarchical movie tree.

Target movies may be an external movie, the default movie, or any movie embedded within another movie. Targets are specified by using a movie path that may include parent and child movie relationships, and may additionally include track and track object target atoms as needed.

By using embedded `kActionTarget` atoms along with parent and child movie target atoms, you can build up paths for movie targets. Note that QuickTime looks for these embedded `kActionTarget` atoms only when evaluating a movie target, and any movie target type may contain a sibling `kActionTarget` atom.

Paths begin from the current movie, which is the movie containing the object that is handling an event. You may go up the tree using a `kTargetParentMovie` atom, or down the tree using one of five new child movie atoms. You may use a `kTargetRootMovie` atom as a shortcut to get to the top of the tree containing an embedded movie and may use the `movieByName` and `movieByID` atoms to specify a root external movie.

The target atoms are:

- `kTargetRootMovie` (leaf atom, no data). This is the root movie containing the action handler.
- `kTargetParentMovie` (leaf atom, no data). This is the parent movie.

Note that there are five ways to specify an embedded child movie. Three of them specify movie track properties. Two specify properties of the currently loaded movie in a movie track.

- `kTargetChildMovieTrackName`. A child movie track specified by track name.
- `kTargetChildMovieTrackID`. A child movie track specified by track ID.
- `kTargetChildMovieTrackIndex`. A child movie track specified by track index.
- `kTargetChildMovieMovieName`. A child movie specified by the currently loaded movie's movie name. The child movie must contain `movieName` user data with the specified name.
- `kTargetChildMovieMovieID`. A child movie specified by the currently loaded movie's movie ID. The child movie must contain `movieID` user data with the specified ID.

## Adding Wired Actions To a Flash Track

---

This section explains the steps you need to follow in order to add wired actions to a Macromedia Flash track. The Flash media handler was introduced in QuickTime 4 to enable a SWF 3.0 file to be treated as a track within a QuickTime movie. See “Flash Media” (page 153) for more information about the Flash media handler.



Sample code (`AddFlashActions`) is provided on the QuickTime SDK, as well as on the QuickTime developer website, that lets you add wired actions to a Flash track.

**Note:** For more detailed information about working with Flash, you can download the Macromedia SWF File Format Specification at <http://www.macromedia.com/software/flash/open/spec/>, along with the SWF File Parser code also at the Macromedia website.

## Extending the SWF Format

---

QuickTime 4 extends the SWF file format to allow the execution of any of its wired actions, in addition to the much smaller set of Flash actions. For example, you may use a SWF file as a user interface element in a QuickTime movie, controlling properties of the movie and other tracks. QuickTime also allows SWF files to be compressed using the zlib data compressor. This can significantly lower the bandwidth required when downloading a SWF file when it is in a QuickTime movie.

By using wired actions within a Flash track, compressing your Flash tracks, and combining Flash tracks with other types of QuickTime media, you can create compact and sophisticated multimedia content.

The SWF File Format Specification consists of a header followed by a series of tagged data blocks. The types of tagged data blocks you need to use are the `DefineButton2` and `DoAction`. The `DefineButton2` block allows Flash actions to be associated with a mouse state transition. `DoAction` allows actions to be executed when the tag is encountered. These are analogous to mouse-related QT event handlers and the frame loaded event in wired movies.

Flash actions are stored in an action record. Each Flash action has its own tag, such as `ActionPlay` and `ActionNextFrame`. QuickTime defines one new tag: `QuickTimeActions`, which is `0xAA`. The data for the `QuickTimeActions` tag is simply a QT atom container with the QuickTime wired actions to execute in it.

There are also fields you need to change in order to add wired actions to a SWF file. Additionally, there is one tag missing from the SWF file format that is described below.

### What You Need to Modify

---

For `defineButton2`, you need to modify or add the following fields: file length, action records offset, the action offset, the condition, the record header size portion, and add action record.

#### File Length

---

A 32-bit field in the SWF file header.

RecordHeader for the `defineButton2`

RecordHeader contains the tag ID and length. You need to update the length. Note that there are short and long formats for record headers, depending on the size of the record. The tag ID for `defineButton2` is 34.

### ActionRecordsOffset

---

The action records offset, a 16-bit field, is missing from the SWF File Format Specification. It occurs between the flags and buttons fields. It is initially set to 0 if there are no actions for the button. If there are actions for the button, then it must contain the offset from the point in the SWF file following this 16-bit value to the beginning of the action offset field.

```
DefineButton2 =
    Header
    ButtonID
    Flags

    ActionRecordsOffset    (this is missing from the spec)

    Buttons
    ButtonEndFlag
    Button2ActionCode
    ActionOffset
    Condition
    Action    [ActionRecords]
    ActionEndFlag
```

### ActionOffset

---

There is one action offset per condition (`mouse overDownToIdle`). This is the offset used to skip over the condition and the following actions (the `ActionRecord`) for the condition. You need to update this value when adding actions.

### Condition

---

The condition field is roughly equivalent to a wired movie event. The actions associated with button state transition condition are triggered when the transition occurs. You need to add or edit this field.

### Actions

---

Flash actions each have their own action tag code. QuickTime actions use a single QuickTime actions code: 'AA'. You may add a list of actions to a single QuickTime actions tag.

The format of the QuickTime actions tag is as follows:

```
1 byte:    // Tag = 'AA'
2 bytes:   // data length (size of the QTAtomContainer)
n bytes:   // the data which is the QTAtomContainer holding the
           // wired actions
```

### DoAction

---

For `DoAction`, you need to modify a subset of the `defineButton2` fields in the same manner as described above. These fields are file length, the record header size portion, and the action record.

Note that you need to write the length fields in little-endian format.

## Creating Video Tracks at 30 Frames per Second

---

The duration of a video frame is stored in the time-to-sample atom contained within a sample table atom. This duration cannot be interpreted without the media's time scale, which defines the units-per-second for the duration. In this example, each frame has the same duration, so the time-to-sample atom has one entry, which applies to all video frames in the media.

As long as the ratio between frame duration and media time scale remains 1:30, any combination of values can be used for the duration and time scale. The larger the time scale the shorter the maximum duration. Since a movie defaults to a time scale of 600, this is a good number to use. It is also the least common multiple for 24, 25, and 30, making it handy for much of the math you are likely to encounter when making a movie.

The movie time scale is independent of the media time scale. Since you want to avoid movie edits that don't land on frame boundaries, it is a good idea to keep the movie time scale and the media time scale the same, or the movie time scale should be an even multiple of the media time scale. The movie time scale is stored in the movie header atom.

With a time scale of 600 in the media header atom, the time-to-sample atom would contain the following data values:

Atom size	24
Atom type	'stts'
Version/Flags	0
Number of entries	1
Sample count	n
Sample duration	20

## Creating Video Tracks at 29.97 Frames per Second

---

NTSC color video is not 30 frames per second (fps), but actually 29.97 fps. The previous example showed how the media time scale and the duration of the frames specify the video's frame rate. By setting the media's time scale to 2997 units per second and setting the frame durations to 100 units each, the effective rate is 29.97 fps exactly.

In this situation, it is also a good idea to set the movie time scale to 2997 in order to avoid movie edits that don't land on frame boundaries. The movie's time scale is stored in the movie header atom.

With a time scale of 2997 in the media header atom, the time-to-sample atom would contain the following data values:

Atom size	24
Atom type	'stts'

Version/Flags	0
Number of entries	1
Sample count	n
Sample duration	100

## Creating Audio Tracks at 44.1 kHz

---

The duration of an audio sample is stored in the time-to-sample atom contained in a sample table atom. This duration cannot be interpreted without the media's time scale, which defines the units per second for the duration. With audio, the duration of each audio sample is typically 1, so the time-to-sample atom has one entry, which applies to all audio samples.

With a time scale of 44100 in the media header atom, the time-to-sample atom would contain the following data values:

Atom size	24
Atom type	'stts'
Version/Flags	0
Number of entries	1
Sample count	n
Sample duration	1

This atom does not indicate whether the audio is stereo or mono or whether it contains 8-bit or 16-bit samples. That information is stored in the sound sample description atom, which is contained in the sample table atom.

## Creating a Timecode Track for 29.97 FPS Video

---

A timecode track specifies timecode information for other tracks. The timecode keeps track of the timecodes of the original source of the video and audio. After a movie has been edited, the timecode can be extracted to determine the source tape and the timecodes of the frames.

It is important that the timecode track have the same time scale as the video track. Otherwise, the timecode will not tick at the exact same time as the video track.

For each contiguous source tape segment, there is a single timecode sample that specifies the timecode value corresponding to the start of the segment. From this sample, the timecode value can be determined for any point in the segment.

Some Useful Examples and Scenarios

The sample description for a timecode track specifies the timecode system being used (for example, a 30-fps drop frame) and the source information. Each sample is a timecode value.

Since the timecode media handler is a derived from the base media handler, the media information atom starts with a generic media header atom. The timecode atoms would contain the following data values:

Atom size	77		
Atom type	'gmhd'		
	Atom size	69	
	Atom type	'gmin'	
	Version/Flags	0	
	Graphics mode	0x0040	
	Opcolor (red)	0x8000	
	Opcolor (green)	0x8000	
	Opcolor (blue)	0x8000	
	Balance	0	
	Reserved	0	
	Atom size	45	
	Atom type	'tmcd'	
		Atom size	37
		Atom type	'tcmi'
		Version/Flags	0
		Text font	0 (system font)
		Text face	0 (plain)
		Text size	12
		Text color (red)	0
		Text color (green)	0
		Text color (blue)	0
		Background color (red)	0
		Background color (green)	0
		Background color (blue)	0

	Font name	'\pChicago' (Pascal string)
--	-----------	-----------------------------

The sample table atom contains all the standard sample atoms and has the following data values:

Atom size	174		
Atom type	'stbl' (sample table)		
	Atom size	74	
	Atom type	'stsd' (sample description)	
	Version/Flags	0	
	Number of entries	1	
	Sample description size [1]	58	
	Data format [1]	'tmcd'	
	Reserved [1]	0	
	Data reference index [1]	1	
	Flags[1]	0	
	Flags (timecode) [1]	7 (drop frame + 24 hour + negative times OK)	
	Time scale[1]	2997	
	Frame duration[1]	100	
	Number of frames [1]	20	
		Atom size	24
		Atom type	'name'
		String length	12
		Language code	0 (English)
		Name	"my tape name"
	Atom size	24	
	Atom type	'stts' (time to sample)	
	Version/Flags	0	
	Number of entries	1	

Sample count[1]	1	
Sample duration[1]	1	
Atom size	28	
Atom type	'stsc' (sample to chunk)	
Version/Flags	0	
Number of entries	1	
First chunk[1]	1	
Samples per chunk[1]	1	
Sample description ID[1]	1	
Atom size	20	
Atom type	'stsz' (sample size)	
Version/Flags	0	
Sample size	4	
Number of entries	1	
Atom size	20	
Atom type	'stco' (chunk offset)	
Version/Flags	0	
Number of entries	1	
Offset [1]	(offset into file of chunk 1)	

In the example, let's assume that the segment's beginning timecode is 1:15:32.4 (1 hour, 15 minutes, 32 seconds, and 4 frames). The time would be expressed in the data file as 0x010F2004 (0x01 = 1 hour; 0x0F = 15 minutes; 0x20 = 32 seconds; 0x04 = 4 frames).

The video and audio tracks must contain a track reference atom to indicate that they reference this timecode track. The track reference is the same for both and is contained in the track atom (at the same level as the track header and media atoms).

This track reference would contain the following data values:

Atom size	12
Atom type	'tref'
Reference type	'tmcd'
Track ID of referenced track (timecode track)	3

In this example, the video and sound tracks are tracks 1 and 2. The timecode track is track 3.

## Playing with Edit Lists

---

A segment of a movie can be repeated without duplicating media data by using edit lists. Suppose you have a single-track movie whose media time scale is 100 and track duration is 1000 (10 seconds). For this example the movie's time scale is 600. If there are no edits in the movie, the edit atom would contain the following data values:

Atom size	36	
Atom type	'edts'	
	Atom size	28
	Atom type	'elst'
	Version/Flags	0
	Number of entries	2
	Track duration	6000 (10 seconds)
	Media time	0
	Media rate	1.0

Because this is a single-track movie, the track's duration in the track header atom is 6000 and the movie's duration in the movie header atom is 6000.

If you change the track to play the media from time 0 to time 2 seconds, and then play the media from time 0 to time 10 seconds, the edit atom would now contain these data values:

Atom size	48	
Atom type	'edts'	
	Atom size	40
	Atom type	'elst'
	Version/Flags	0
	Number of entries	2
	Track duration[1]	1200 (2 seconds)
	Media time[1]	0
	Media rate[1]	1.0



	Track duration[2]	6000 (10 seconds)
	Media time[2]	0
	Media rate[2]	1.0

Because the track is now 2 seconds longer, the track’s duration in the track header atom must now be 7200, and the movie’s duration in the movie header atom must also be 7200.

Currently, the media plays from time 0 to time 2, then plays from time 0 to time 10. If you take that repeated segment at the beginning (time 0 to time 2) and play it at double speed to maintain the original duration, the edit atom would now contain the following values:

Atom size	60	
Atom type	'edts'	
	Atom size	52
	Atom type	'elst'
	Version/Flags	0
	Number of entries	3
	Track duration[1]	600 (1 second)
	Media time[1]	0
	Media rate[1]	2.0
	Track duration[2]	600 (1 second)
	Media time[2]	0
	Media rate[2]	2.0
	Track duration[3]	4800 (8 seconds)
	Media time[3]	200
	Media rate[3]	1.0

Because the track is now back to its original duration of 10 seconds, its duration in the track header atom is 6000, and the movie’s duration in the movie header atom is 6000.

## Interleaving Movie Data

In order to get optimal movie playback, you must create the movie with interleaved data. Because the data for the movie is placed on disk in time order, the data for a particular time in the movie is close together in the file. This means that you will have to intersperse the data from different tracks. To illustrate this, consider a movie with a single video and a single audio track.

Figure 5-7 (page 250) shows how the movie data was collected, and how the data would need to be played back for proper synchronization. In this example, the video data is recorded at 10 frames per second and the audio data is grouped into half-second chunks.

**Figure 5-7** Non-interleaved movie data

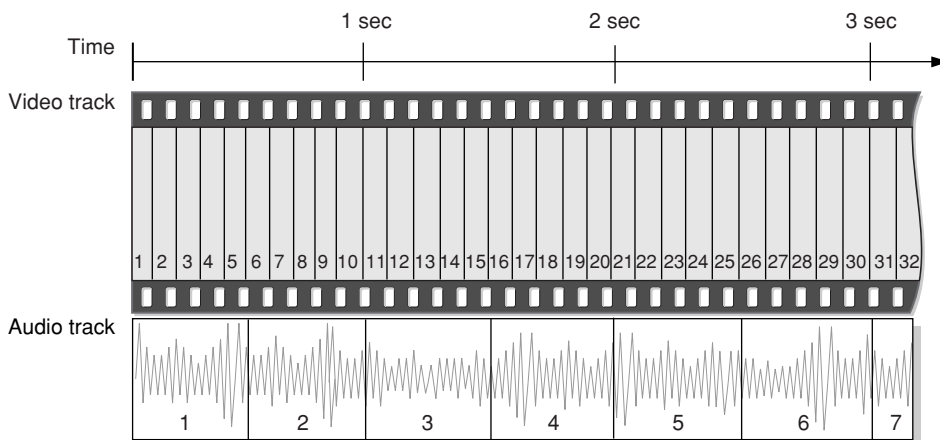

After the data has been interleaved on the disk, the movie data atom would contain movie data in the order shown in Figure 5-8 (page 250).

**Figure 5-8** Interleaved movie data

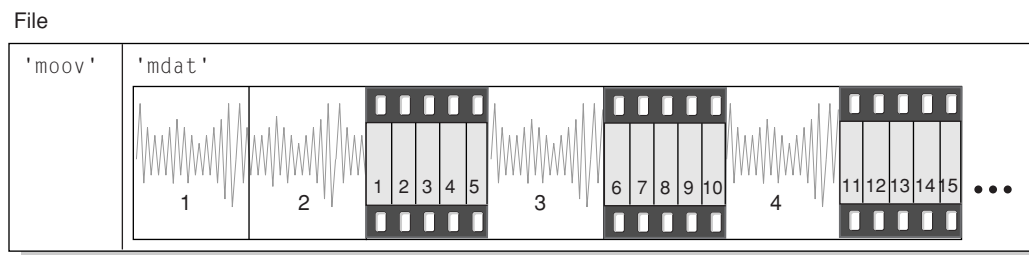

In this example, the file begins with the movie atom ('moov'), followed by the movie data atom ('mdat'). In order to overcome any latencies in sound playback, at least one second of sound data is placed at the beginning of the interleaved data. This means that the sound and video data are offset from each other in the file by one second.

## Referencing Two Data Files With a Single Track

---

The data reference index to be used for a given media sample is stored within that sample's sample description. Therefore, a track must contain multiple sample descriptions in order for that track to reference multiple data files. A different sample description must be used whenever the data file changes or whenever the format of the data changes. The sample-to-chunk atom determines which sample description to use for a sample.

The sample description atom would contain the following data values:

Atom size	...	
Atom type	'stsd'	
Version/Flags	0	
Number of entries	2	
	Sample description size[1]	...
	Data format	'tmcd'
	Reserved	0
	Data reference index	1
	(sample data)	...
	Sample description size[1]	...
	Data format	'tmcd'
	Reserved	0
	Data reference index	2
	(sample data)	...

If there is only 1 sample per chunk and the first 10 samples are extracted from sample description 2 and the next 30 samples are extracted from sample description 1, the sample-to-chunk atom would contain the following data values:

Atom size	40
Atom type	'stsc'
Version/Flags	0
Number of entries	2
First chunk[1]	1
Samples per chunk[1]	1

Sample description ID[1]	2
First chunk[2]	11
Samples per chunk[2]	1
Sample description ID[2]	1

The data reference atom would contain the following data values:

Atom size	...	
Atom type	'dinf'	
	Atom size	...
	Atom type	'dref'
	Version/Flags	0
	Number of entries	2
	Size[1]	...
	Type[1]	'alis'
	Version[1]	0
	Flags[1]	0 (not self referenced)
	Data reference[1]	[alias pointing to file #1]
	Size[2]	...
	Type[2]	'rsrc'
	Version[2]	0
	Flags[2]	0 (not self referenced)
	Data reference[2]	[alias pointing to file #2]

## Getting the Name of a QuickTime VR Node

---

You can use standard QuickTime atom container functions to retrieve the information in a QuickTime VR node header atom. For example, the `MyGetNodeName` function defined in [Listing 5-14](#) (page 252) returns the name of a node, given its node ID.

**Listing 5-14** Getting a node's name

```
OSErr MyGetNodeName (QTVRInstance theInstance, UInt32 theNodeID,
```

```

                                                                    StringPtr
theStringPtr)
{
    OSErr                theErr = noErr;
    QTAtomContainer      theNodeInfo;
    QTVRNodeHeaderAtomPtr theNodeHeader;
    QTAtom               theNodeHeaderAtom = 0;

    //Get the node information atom container.
    theErr = QTVRGetNodeInfo(theInstance, theNodeID, &theNodeInfo);

    //Get the node header atom.
    if (!theErr)
        theNodeHeaderAtom = QTFindChildByID(theNodeInfo, kParentAtomIsContainer,
1, nil);
        kQTVRNodeHeaderAtomType,
        if (theNodeHeaderAtom != 0) {
            QTLockContainer(theNodeInfo);

            //Get a pointer to the node header atom data.
            theErr = QTGetAtomDataPtr(theNodeInfo, theNodeHeaderAtom, nil,
                (Ptr
                *)&theNodeHeader);
            //See if there is a name atom.
            if (!theErr && theNodeHeader->nameAtomID != 0) {
                QTAtom theNameAtom;
                theNameAtom = QTFindChildByID(theNodeInfo, kParentAtomIsContainer,
                    kQTVRStringAtomType, theNodeHeader->nameAtomID,
                nil);
                if (theNameAtom != 0) {
                    VRStringAtomPtr theStringAtomPtr;

                    //Get a pointer to the name atom data; copy it into the string.
                    theErr = QTGetAtomDataPtr(theNodeInfo, theNameAtom, nil,
                        (Ptr
                        *)&theStringAtomPtr);
                    if (!theErr) {
                        short theLen = theStringAtomPtr->stringLength;
                        if (theLen > 255)
                            theLen = 255;
                        BlockMove(theStringAtomPtr->string, &theStringPtr[1],
                theLen);
                            theStringPtr[0] = theLen;
                    }
                }
            }
            QTUnlockContainer(theNodeInfo);
        }

    QTDisposeAtomContainer(theNodeInfo);
    return(theErr);
}

```

The `MyGetNodeName` function defined in [Listing 5-14](#) (page 252) retrieves the node information atom container (by calling `QTVRGetNodeInfo`) and then looks inside that container for the node header atom with atom ID 1. If it finds one, it locks the container and then gets a pointer to the node header atom data. The desired information, the node name, is contained in the string atom whose atom ID is specified by the `nameAtomID` field of the node header structure. Accordingly, the `MyGetNodeName`

function then calls `QTFindChildByID` once again to find that string atom. If the string atom is found, `MyGetNodeName` calls `QTGetAtomDataPtr` to get a pointer to the string atom data. Finally, `MyGetNodeName` copies the string data into the appropriate location and cleans up after itself before returning.

## Adding Custom Atoms in a QuickTime VR Movie

---

If you author a QuickTime VR movie, you may choose to add custom atoms to either the VR world or node information atom containers. Those atoms can be extracted within an application to provide additional information that the application may use.

Information that pertains to the entire scene might be stored in a custom atom within the VR world atom container. Node-specific information could be stored in the individual node information atom containers or as sibling atoms to the node location atoms within the VR world.

Custom hot spot atoms should be stored as siblings to the hot spot information atoms in the node information atom container. Generally, its atom type is the same as the custom hot spot type. You can set up an intercept procedure in your application in order to process clicks on the custom hot spots.

If you use custom atoms, you should install your hot spot intercept procedure when you open the movie. [Listing 5-15](#) (page 254) is an example of such an intercept procedure.

**Listing 5-15** Typical hot spot intercept procedure

```
QTVRInterceptProc MyProc = NewQTVRInterceptProc (MyHotSpot);
QTVRInstallInterceptProc (qtvr, kQTVRTriggerHotSpotSelector, myProc, 0, 0);

pascal void MyHotSpot (QTVRInstance qtvr, QTVRInterceptPtr qtvrMsg,
                      SInt32 refCon, Boolean *cancel)
{
    UInt32 hotSpotID = (UInt32) qtvrMsg->parameter[0];
    QTAAtomContainer nodeInfo =
        (QTAAtomContainer) qtvrMsg->parameter[1];
    QTAAtom hotSpotAtom = (QTAAtom) qtvrMsg->parameter[2];
    OSType hotSpotType;
    CustomData myCustomData;
    QTAAtom myAtom;

    QTVRGetHotSpotType (qtvr, hotSpotID, &hotSpotType);
    if (hotSpotType != kMyAtomType) return;

    // It's our type of hot spot - don't let anyone else handle it
    *cancel = true;

    // Find our custom atom
    myAtom = QTFindChildByID (nodeInfo, hotSpotAtom, kMyAtomType, 1, nil);
    if (myAtom != 0) {
        OSErr err;
        // Copy the custom data into our structure
        err = QTCopyAtomDataToPtr (nodeInfo, myAtom, false,
                                   sizeof(CustomData), &myCustomData, nil);
        if (err == noErr)
```

```

        // Do something with it
        DoMyHotSpotStuff (hotSpotID, &myCustomData);
    }
}

```

Your intercept procedure is called for clicks on any hot spot. You should check to see if it is your type of hot spot and, if so, extract the custom hot spot atom and do whatever is appropriate for your hot spot type (`DoMyHotSpotStuff`).

When you no longer need the intercept procedure you should call `QTVRInstallInterceptProc` again with the same selector and a `nil` procedure pointer and then call `DisposeRoutineDescriptor` on `myProc`.

Apple reserves all hot spot and atom types with lowercase letters. Your custom hot spot type should contain all uppercase letters.

## Adding Atom Containers in a QuickTime VR Movie

---

Assuming you have already created the QuickTime VR world and node information atom containers, you would use the code (minus error checking) [Listing 5-16](#) (page 255) to add them to the QTVR track.

**Listing 5-16** Adding atom containers to a track

```

long descSize;
QTVRSampleDescriptionHandle qtvrSampleDesc;

// Create a QTVR sample description handle

descSize = sizeof(QTVRSampleDescription) + GetHandleSize((Handle) vrWorld) -
           sizeof(UInt32);
qtvrSampleDesc = (QTVRSampleDescriptionHandle) NewHandleClear (descSize);
(*qtvrSampleDesc)->size = descSize;
(*qtvrSampleDesc)->type = kQTVRQTVRType;

// Copy the VR world atom container data into the QTVR sample description
BlockMove (*(Handle) vrWorld), &((*qtvrSampleDesc)->data),
           GetHandleSize((Handle) vrWorld));
// Now add it to the QTVR track's media
err = BeginMediaEdits (qtvrMedia);
err = AddMediaSample (qtvrMedia, (Handle) nodeInfo, 0,
                    GetHandleSize((Handle) nodeInfo), duration,
                    (SampleDescriptionHandle) qtvrSampleDesc, 1, 0, &sampleTime);
err = EndMediaEdits (qtvrMedia);
InsertMediaIntoTrack (qtvrTrack, trackTime, sampleTime, duration, 1L<<16);

```

The `duration` value is computed based on the duration of the corresponding image track samples for the node. The value of `trackTime` is the time for the beginning of the current node (zero for a single node movie). The values of `duration` and `sampleTime` are in the time base of the media; the value of `trackTime` is in the movie's time base.

## Optimizing QuickTime VR Movies for Web Playback

---

Originally, both QuickTime movies and QuickTime VR movies had to be completely downloaded to the user's local hard disk before they could be viewed. Starting with QuickTime 2.5, if the movie data is properly laid out in the file, standard linear QuickTime movies can be viewed almost immediately. The frames that have been downloaded so far are shown while subsequent frames continue to be downloaded.

The important change that took place to allow this to happen was for QuickTime to place global movie information at the beginning of the file. Originally, this information was at the end of the file. After that, the frame data simply needs to be in order in the file. Similarly, QuickTime VR files also need to be laid out in a certain manner in order to get some sort of quick feedback when viewing on the web. Roughly speaking this involves writing out all of the media samples in the file in a particular order. Apple now provides a movie export component that does this for you: the QTVR Flattener.

### The QTVR Flattener

---

The QTVR Flattener is a movie export component that converts an existing QuickTime VR single node movie into a new movie that is optimized for the Web. Not only does the flattener reorder the media samples, but for panoramas it also creates a small preview of the panorama. When viewed on the Web, this preview appears after 5% to 10% of the movie data has been downloaded, allowing users to see a lower-resolution version of the panorama.

Using the QTVR flattener from your application is quite easy. After you have created the QuickTime VR movie, you simply open the QTVR Flattener component and call the `MovieExportToFile` routine as shown in [Listing 5-17](#) (page 256).

#### Listing 5-17 Using the flattener

```
ComponentDescription desc;
Component flattener;
ComponentInstance qtvrExport = nil;
desc.componentType = MovieExportType;
desc.componentSubType = MovieFileType;
desc.componentManufacturer = QTVRFlattenerType;
flattener = FindNextComponent(nil, &desc);
if (flattener) qtvrExport = OpenComponent (flattener);
if (qtvrExport)
    MovieExportToFile (qtvrExport, &myFileSpec, myQTVRMovie, nil, 0, 0);
```

The code fragment shown in [Listing 5-17](#) (page 256) creates a flattened movie file specified by the `myFileSpec` parameter. If your QuickTime VR movie is a panorama, the flattened movie file includes a quarter size, blurred JPEG, compressed preview of the panorama image.



**Note:** The constants `MovieExportType` and `MovieFileType` used in [Listing 5-17](#) (page 256) are defined in header files `QuickTimeComponents.h` and `Movies.h` respectively and are defined as `'spit'` and `'MooV'`.

You can present users with the QTVR Flattener's own dialog box to allow them to choose options such as how to compress the preview image or to select a separate preview image file. Use the following code to show the dialog box:

```
err = MovieExportDoUserDialog (qtvrExport, myQTVRMovie, nil, 0, 0,
&cancel);
```

If the user cancels the dialog box, then the Boolean `cancel` is set to `true`.

If you do not want to present the user with the flattener's dialog box, you can communicate directly with the component by using the `MovieExportSetSettingsFromAtomContainer` routine as described in the following paragraphs.

If you want to specify a preview image other than the default, you need to create a special atom container and then call `MovieExportSetSettingsFromAtomContainer` before calling `MovieExportToFile`. You can specify how to compress the image, what resolution to use, and you can even specify your own preview image file to be used. The atom container you pass in can have various atoms that specify certain export options. These atoms must all be children of a flattener settings parent atom.

The preview resolution atom is a 16-bit value that allows you to specify the resolution of the preview image. This value, which defaults to `kQTVRQuarterRes`, indicates how much to reduce the preview image.

The blur preview atom is a Boolean value that indicates whether to blur the image before compressing. Blurring usually results in a much more highly compressed image. The default value is `true`.

The create preview atom is a Boolean value that indicates whether a preview image should be created. The default value is `true`.

The import preview atom is a Boolean value that is used to indicate that the preview image should be imported from an external file rather than generated from the image in the panorama file itself. This allows you to have any image you want as the preview for the panorama. You can specify which file to use by also including the import specification atom, which is an `FSSpec` data structure that identifies the image file. If you do not include this atom, then the flattener presents the user with a dialog box asking the user to select a file. The default for import preview is `false`. If an import file is used, the image is used at its natural size and the resolution setting is ignored.

## Sample Atom Container for the QTVR Flattener

---

The sample code in [Listing 5-18](#) (page 257) creates an atom container and adds atoms to indicate an import preview file for the flattener to use.

**Listing 5-18** Specifying a preview file for the flattener to use

```
Boolean yes = true;
QTAtomContainer exportData;
QTAtom parent;
```

```

err = QTNewAtomContainer(&exportData);
// create a parent for the other settings atoms
err = QTInsertChild (exportData, kParentAtomIsContainer,
    QTVRFlattenerParentAtomType, 1, 0, 0, nil, &parent);
// Add child atom to indicate we want to import the preview from a file
err = QTInsertChild (exportData, parent, QTVRImportPreviewAtomType, 1, 0,
    sizeof (yes), &yes, nil);
// Add child atom to tell which file to import
err = QTInsertChild (exportData, parent, QTVRImportSpecAtomType, 1, 0,
    sizeof (previewSpec), &previewSpec, nil);
// Tell the export component
MovieExportSetSettingsFromAtomContainer (qtvExport, exportData);

```

Overriding the compression settings is a bit more complicated. You need to open a standard image compression dialog component and make calls to obtain an atom container that you can then pass to the QTVR Flattener component.

**Listing 5-19** Overriding the compression settings

```

ComponentInstance sc;
QTAtomContainer compressorData;
SCSpatialSettings ss;
sc = OpenDefaultComponent(StandardCompressionType, StandardCompressionSubType);
ss.codecType = kCinepakCodecType;
ss.codec = nil;
ss.depth = 0;
ss.spatialQuality = codecHighQuality;
err = SCSetInfo(sc, scSpatialSettingsType, &ss);
err = SCGetSettingsAsAtomContainer(sc, &compressorData);
MovieExportSetSettingsFromAtomContainer (qtvExport, compressorData);

```

# QuickTime Image File Format

This appendix describes QuickTime image files, which are intended to provide the most useful container for QuickTime-compressed still images.

Most still image file formats define both how images should be stored and compressed. However, the QuickTime image file format is a container format, which describes a storage mechanism independent of compression. The QuickTime image file format uses the same atom-based structure as a QuickTime movie.

## Atom Types in QuickTime Image Files

There are two mandatory atom types: 'idsc', which contains an image description, and 'idat', which contains the image data. This is illustrated in [Figure A-1](#) (page 259). A QuickTime image file can also contain other atoms. For example, it can contain single-fork preview atoms.

In QuickTime 4, there is a new optional atom type 'iccc', which can store a ColorSync profile.

[Figure A-1](#) (page 259) shows an example QuickTime image file containing a JPEG-compressed image.

**Figure A-1** An 'idsc' atom followed by an 'idat' atom

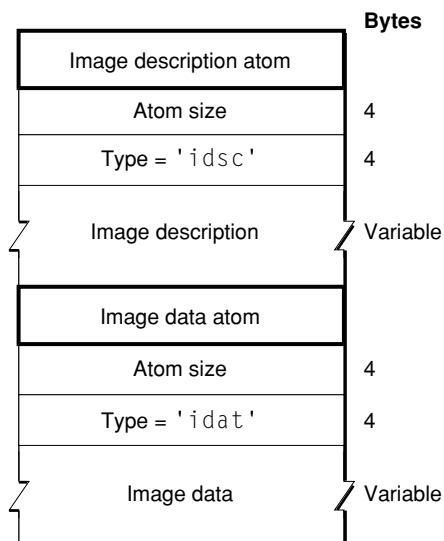

**Table A-1** A QuickTime image file containing JPEG-compressed data

0000005E	Atom size, 94 bytes
69647363	Atom type, 'idsc'
00000056	Image description size, 86 bytes
6A706567	Compressor identifier, 'jpeg'
00000000	Reserved, set to 0
0000	Reserved, set to 0
0000	Reserved, set to 0
00000000	Major and minor version of this data, 0 if not applicable
6170706C	Vendor who compressed this data, 'appl'
00000000	Temporal quality, 0 (no temporal compression)
00000200	Spatial quality, <code>codecNormalQuality</code>
0140	Image width, 320
00F0	Image height, 240
00480000	Horizontal resolution, 72 dpi
00480000	Vertical resolution, 72 dpi
00003C57	Data size, 15447 bytes (use 0 if unknown)
0001	Frame count, 1
0C 50 68 6F 74 6F 20 2D20 4A 50 45 47 00 00 00 00 00 00 00 00 00 00 00 00 00 00 00 00 00 00 00	Compressor name, "Photo - JPEG" (32-byte Pascal string)
0018	Image bit depth, 24
FFFF	Color lookup table ID, -1 (none)
00003C5F	Atom size, 15455 bytes
69646174	Atom type, 'idat'
FF D8 FF E0 00 10 4A 46 49 46 00 01 01 01 00 48 ...	JPEG compressed data

**Important:** The exact order and size of atoms is not guaranteed to match the example in [Figure A-1](#) (page 259). Applications reading QuickTime image files should always use the atom size to traverse the file and ignore atoms of unrecognized types.

**Note:** Like QuickTime movie files, QuickTime image files are big-endian. However, image data is typically stored in the same byte order as specified by the particular compression format.

## Recommended File Type and Suffix

---

Because the QuickTime image file is a single-fork format, it works well in cross-platform applications. On Mac OS systems, QuickTime image files are identified by the file type 'qtif'. Apple recommends using the filename extension `.QIF` to identify QuickTime image files on other platforms.



# Defining Media Data Layouts

---

The QuickTime file format provides a great deal of flexibility in how media data is physically arranged within a file. However, it also allows media layouts to be created that may be inefficient for playback on a given device. To complicate the matter, a media layout that is inefficient for one device may be, in fact, very efficient for another. The purpose of this appendix is to define some common uses of QuickTime files and describe the media layout in these circumstances.

## Using QuickTime Files and Media Layouts

---

A QuickTime file can reference media data stored in a number of files, including the file itself. If a QuickTime file references only media data contained within itself, the file is said to be self-contained. A QuickTime file can also reference media data stored in files that are not QuickTime files. This is because the QuickTime file format references media within a URL by file offset, rather than by a data structuring mechanism of a particular file format. This allows a QuickTime file to refer to data stored in any container format.

Often, it is convenient to store a single media stream per file, for example, when encoding content. It is also useful for purposes of reusing content. (To reuse an elementary stream, it is not necessary to extract it from a larger, possibly multiplexed file.)

Because QuickTime can reference media stored in any file, it is not required that media be stored in the QuickTime file format. However, this is recommended. Putting the elementary streams in a QuickTime file has several advantages, particularly in enabling interchange of the content between different tools. Further, the QuickTime file format adds very little overhead to the media—as little as a few hundred bytes in many cases—so there is no great penalty in storage space.

One of the issues facing any device (a server or a local workstation) that is attempting to play back a QuickTime file in real time is the number of file seeks that must be performed.

It is possible to arrange the data in a QuickTime file to minimize, and potentially eliminate, any seeks during the course of normal playback. (Of course, random access and other kinds of interactivity require seeks.) Minimizing seeks is accomplished by interleaving the media data in the QuickTime file in such a way that the layout of the media in the file corresponds to the order in which the media data will be required. It is expected that most servers, for example, will stream QuickTime media using the facilities of the hint tracks.

Take a scenario where the QuickTime file contains a single hint track that references an audio and a visual media stream. In order to eliminate all seeks, the hint track media must be interleaved with the audio and visual stream data. Because the hint track sample must always be read before the audio and visual media that it references, the hint track samples must always immediately precede the samples they reference.

A simple illustration of the ordering of data (that is, time and file offset increasing from left to right) is as follows:

```
H0 A0 H1 V1 H2 V2 H3 A1 H4 A2 V3 H5 V4
```

When a single hint sample references multiple pieces of media data, those pieces of media data must occur in the order that they are referenced.



# Random Access

---

This appendix describes how to seek with a QuickTime file using child atoms.

## Seeking With a QuickTime File

---

Seeking with a QuickTime file is accomplished primarily by using the child atoms contained in the sample table atom. If an edit list is present, it must also be consulted. If you want to seek a given track to a time  $T$ , where  $T$  is in the time scale of the movie header atom, you could perform the following operations:

1. If the track contains an edit list, determine which edit contains the time  $T$  by iterating over the edits. The start time of the edit in the movie time scale must then be subtracted from the time  $T$  to generate  $T'$ , the duration into the edit in the movie time scale.  $T'$  is next converted to the time scale of the track's media to generate  $T''$ . Finally, the time in the media scale to use is calculated by adding the media start time of the edit to  $T''$ .
2. The time-to-sample atom for a track indicates what times are associated with which sample for that track. Use this atom to find the first sample prior to the given time.
3. The sample that was located in step 1 may not be a random access point. Locating the nearest random access point requires consulting two atoms. The sync sample table indicates which samples are in fact random access points. Using this table, you can locate which is the first sync sample prior to the specified time. The absence of the sync sample table indicates that all samples are synchronization points, and makes this problem easy. The shadow sync atom gives the opportunity for a content author to provide samples that are not delivered in the normal course of delivery, but which can be inserted to provide additional random access points. This improves random access without impacting bitrate during normal delivery. This atom maps samples that are not random access points to alternate samples which are. You should also consult this table if present to find the first shadow sync sample prior to the sample in question. Having consulted the sync sample table and the shadow sync table, you probably wish to seek to whichever resultant sample is closest to, but prior to, the sample found in step 1.
4. At this point you know the sample that will be used for random access. Use the sample-to-chunk table to determine in which chunk this sample is located.
5. Knowing which chunk contained the sample in question, use the chunk offset atom to figure out where that chunk begins.

6. Starting from this offset, you can use the information contained in the sample-to-chunk atom and the sample size atom to figure out where within this chunk the sample in question is located. This is the desired information.

# Metadata Handling

This appendix describes how metadata is handled when QuickTime imports other file formats. (For more information about metadata, refer to [“Overview of the File Format”](#) (page 19) and [“Compressed Movie Resources”](#) (page 88)).

These formats are grouped into the following categories and sections:

- [“Digital Video File Formats”](#) (page 267)
- [“Digital Audio File Formats”](#) (page 268)
- [“Still Image File Formats”](#) (page 269)
- [“Animation and 3D File Formats ”](#) (page 270)

Each section includes a table with specific details on the following, where applicable:

- The format supported by QuickTime—for example, the movie import component or the graphics import component
- The Macintosh file type—for example, 'Mp3 '
- File name extensions—for example, .mp3
- Specific details for metadata handling—for example, all Microsoft-defined “tombstone” data is transferred to the imported movie’s user data. metadata fields that have QuickTime equivalents are mapped as follows.
- Software required—for example, QuickTime 3 or later

## Digital Video File Formats

OpenDML and other AVI files	Description
Supported by	Movie import component
Macintosh file type	'VfW '
File name extensions	.avi

OpenDML and other AVI files	Description
metadata handling	All Microsoft-defined “tombstone” data is transferred to the imported movie’s user data. metadata fields that have QuickTime equivalents are mapped as follows: 'ICOP' maps to kUserDataTextCopyright, 'ISBJ' maps to kUserDataTextInformation, 'INAM' maps to kUserDataTextFullName, 'ICRD' maps to '@day', 'IMED' maps to '@fmt', 'ISRC' maps to '@src'. Where no QuickTime equivalent exists, the metadata item’s four-character code is modified by replacing the initial I with the symbol ©. All other characters remain unchanged.
Software required	QuickTime 3

## Digital Audio File Formats

---

MPEG 1 layer 3	Description
Supported by	Movie import component
Macintosh file type	'Mp3 ', 'SwaT', 'MPEG', 'PLAY', 'MPG3', 'MP3 '
File name extensions	.mp3, .swa
Metadata handling	Metadata from ID3v1-style MP3 files is imported into the QuickTime movie. Title maps to kUserDataTextFullName, artist maps to '@ART', album maps to '@alb', year maps to '@day', comment maps to '@cmt', and track number maps to '@des'.
Software required	QuickTime 4

WAV	Description
Supported by	Movie import component
Macintosh file type	'WAVE', '.WAV'
File name extensions	.wav
Metadata handling	All Microsoft-defined “tombstone” data is transferred to the imported movie’s user data. metadata fields that have QuickTime equivalents are mapped as follows: 'ICOP' maps to kUserDataTextCopyright, 'ISBJ' maps to kUserDataTextInformation, 'INAM' maps to kUserDataText-FullName, 'ICRD' maps to '@day', 'IMED' maps to '@fmt', 'ISRC' maps to '@src'. Where no QuickTime equivalent exists, the metadata item’s four-character code is modified by replacing the initial I with the symbol ©. All other characters remain unchanged.
Software required	QuickTime 2.5 or later

## Still Image File Formats

---

FlashPix	Description
Supported by	Graphics import component
Macintosh file type	'FPix'
File name extensions	.fpx
Metadata handling	Information about copyright, authorship, caption text, content description notes, camera manufacturer name, camera model name are transferred to <code>kUserDataTextCopyright</code> , <code>kUserDataTextArtistField</code> , <code>kUserDataText-FullName</code> , <code>kParameterInfoWindowTitle</code> , <code>kParameterInfoManufacturer</code> , <code>kUserDataTextMakeField</code> user data items, respectively.
Formats supported	1.0
Software required	QuickTime 4

GIF	Description
Supported by	Graphics import component
Macintosh file type	'GIFf', or 'GIF '
File name extensions	.gif
Metadata handling	The GIF comment field is transferred to the <code>kUserDataDateTextInformation</code> user data item.
Software required	QuickTime 2.5 or later

JFIF/JPEG	Description
Supported by	Graphics import component
Macintosh file type	'JPEG'
File name extensions	.jpg
Metadata handling	The JFIF comment field is transferred to the imported Movie's user data in the <code>kUserDataTextInformation</code> field.
Software required	QuickTime 2.5 or later

Photoshop	Description
Supported by	Graphics import component

Photoshop	Description
Macintosh file type	'8BPS'
File name extensions	.psd
Metadata handling	Photoshop files store their metadata based on the IPTC-NAA Information Interchange Model and Digital Newsphoto Parameter Record. This information is transferred into the importer Movie's user data. The entire IPTC-NAA record is placed into a user data item of type 'iptc'. In addition, those metadata items which are defined by QuickTime are mapped directly to QuickTime types as follows: 116 to kUserDataTextCopyright, 120 to kUserDataTextInformation, 105 to kUserDataTextFullName, 55 to '@day', 115 to '@src'.
Software required	QuickTime 2.5 or later. QuickTime 3 is required for metadata handling.

QuickTime Image File	Description
Supported by	Graphics import component
Macintosh file type	'qtif'
File name extensions	.qtif, .qif, .qti
Metadata handling	Metadata that is stored in quickTimeImageFileMetaDataAtom atom is copied directly to the Movie's user data.
Formats supported	All
Software required	QuickTime 2.5 or later

TIFF	Description
Supported by	Graphics Import Component
Macintosh file type	'TIFF'
File name extensions	.tif, .tiff
Metadata handling	Extracted from standard tags and from IPTC block
Software required	QuickTime 3 or later

## Animation and 3D File Formats

---

Animated GIF	Description
Supported by	Movie import component

Animated GIF	Description
Macintosh file type	'GIFf'
File name extensions	.gif
Metadata handling	The GIF comment field is transferred to <code>kUserDataTextInformation</code> user data item.
Software required	QuickTime 3 or later





# Summary of VR World and Node Atom Types

This appendix includes information that pertains to Chapter 3, “VR World Atom Container” (page 181) and “Node Information Atom Container” (page 186).

## C Summary

### Constants

#### VR World Atom Types

```
enum {
    kQTVRWorldHeaderAtomType    = FOUR_CHAR_CODE('vrsc'),
    kQTVRImagingParentAtomType  = FOUR_CHAR_CODE('imgp'),
    kQTVRPanoImagingAtomType    = FOUR_CHAR_CODE('impn'),
    kQTVRObjectImagingAtomType  = FOUR_CHAR_CODE('imob'),
    kQTVRNodeParentAtomType     = FOUR_CHAR_CODE('vrnp'),
    kQTVRNodeIDAtomType         = FOUR_CHAR_CODE('vrni'),
    kQTVRNodeLocationAtomType   = FOUR_CHAR_CODE('nloc')
};
```

#### Node Information Atom Types

```
enum {
    kQTVRNodeHeaderAtomType     = FOUR_CHAR_CODE('ndhd'),
    kQTVRHotSpotParentAtomType  = FOUR_CHAR_CODE('hspa'),
    kQTVRHotSpotAtomType        = FOUR_CHAR_CODE('hots'),
    kQTVRHotSpotInfoAtomType    = FOUR_CHAR_CODE('hsin'),
    kQTVRLinkInfoAtomType       = FOUR_CHAR_CODE('link')
};
```

#### Miscellaneous Atom Types

```
enum {
    kQTVRStringAtomType         = FOUR_CHAR_CODE('vrsg'),
    kQTVRPanoSampleDataAtomType = FOUR_CHAR_CODE('pdat'),
    kQTVRObjectInfoAtomType     = FOUR_CHAR_CODE('obji'),
};
```

Summary of VR World and Node Atom Types

```

kQTVRAltImageTrackRefAtomType = FOUR_CHAR_CODE('imtr'),
kQTVRAltHotSpotTrackRefAtomType = FOUR_CHAR_CODE('hstr'),
kQTVRAngleRangeAtomType = FOUR_CHAR_CODE('arng'),
kQTVRTrackRefArrayAtomType = FOUR_CHAR_CODE('tref'),
kQTVRPanConstraintAtomType = FOUR_CHAR_CODE('pcon'),
kQTVRTiltConstraintAtomType = FOUR_CHAR_CODE('tcon'),
kQTVRFOVConstraintAtomType = FOUR_CHAR_CODE('fcon'),
kQTVRCubicViewAtomType = FOUR_CHAR_CODE('cuvw'),
kQTVRCubicFaceDataAtomType = FOUR_CHAR_CODE('cufa')
};

```

Track Reference Types

---

```

enum {
    kQTVRImageTrackRefType = FOUR_CHAR_CODE('imgt'),
    kQTVRHotSpotTrackRefType = FOUR_CHAR_CODE('hott')
};

```

Imaging Property Valid Flags

---

```

enum {
    kQTVRValidCorrection = 1 << 0,
    kQTVRValidQuality = 1 << 1,
    kQTVRValidDirectDraw = 1 << 2,
    kQTVRValidFirstExtraProperty = 1 << 3
};

```

Link Hot Spot Valid Bits

---

```

enum {
    kQTVRValidPan = 1 << 0,
    kQTVRValidTilt = 1 << 1,
    kQTVRValidFOV = 1 << 2,
    kQTVRValidViewCenter = 1 << 3
};

```

Animation Settings

---

```

enum QTVRAnimationSettings {
    kQTVRObjectAnimateViewFramesOn = (1 << 0),
    kQTVRObjectPalindromeViewFramesOn = (1 << 1),
    kQTVRObjectStartFirstViewFrameOn = (1 << 2),
    kQTVRObjectAnimateViewsOn = (1 << 3),
    kQTVRObjectPalindromeViewsOn = (1 << 4),
    kQTVRObjectSyncViewToFrameRate = (1 << 5),
    kQTVRObjectDontLoopViewFramesOn = (1 << 6),
    kQTVRObjectPlayEveryViewFrameOn = (1 << 7)
};

```

Control Settings

---

```

enum QTVRControlSettings {
    kQTVRObjectWrapPanOn = (1 << 0),
};

```

Summary of VR World and Node Atom Types

```

    kQTVRObjectWrapTiltOn           = (1 << 1),
    kQTVRObjectCanZoomOn           = (1 << 2),
    kQTVRObjectReverseHControlOn   = (1 << 3),
    kQTVRObjectReverseVControlOn   = (1 << 4),
    kQTVRObjectSwapHVControlOn     = (1 << 5),
    kQTVRObjectTranslationOn       = (1 << 6)
};

```

Controller Subtype and ID

---

```

enum {
    kQTControllerType           = FOUR_CHAR_CODE('ctyp'),
    kQTControllerID             = 1
};

```

Object Controller Types

---

```

enum ObjectUITypes {
    kGrabberScrollerUI         = 1,
    kOldJoyStickUI             = 2,
    kJoystickUI                 = 3,
    kGrabberUI                  = 4,
    kAbsoluteUI                 = 5
};

```

Node Location Flag

---

```

enum {
    kQTVRSameFile              = 0
};

```

Panorama Sample Flag

---

```

enum {
    kQTVRPanoFlagHorizontal    = 1 << 0,
    kQTVRPanoFlagAlwaysWrap    = 1 << 2
};

```

Data Types

---

```

typedef float                  Float32;

```

Sample Description Header Structure

---

```

typedef struct QTVRSampleDescription {
    UInt32          size;
    UInt32          type;
    UInt32          reserved1;
    UInt16          reserved2;
    UInt16          dataRefIndex;
    UInt32          data;
};

```

Summary of VR World and Node Atom Types

```
} QTVRSampleDescription, *QTVRSampleDescriptionPtr, **QTVRSampleDescriptionHandle;
```

**String Atom Structure**

---

```
typedef struct QTVRStringAtom {
    UInt16                stringUsage;
    UInt16                stringLength;
    unsigned char         string[4];
} QTVRStringAtom, *QTVRStringAtomPtr;
```

**VR World Header Atom Structure**

---

```
typedef struct QTVRWorldHeaderAtom {
    UInt16                majorVersion;
    UInt16                minorVersion;
    QTAtomID              nameAtomID;
    UInt32                defaultNodeID;
    UInt32                vrWorldFlags;
    UInt32                reserved1;
    UInt32                reserved2;
} QTVRWorldHeaderAtom, *QTVRWorldHeaderAtomPtr;
```

**Panorama-Imaging Atom Structure**

---

```
typedef struct QTVRPanoImagingAtom {
    UInt16                majorVersion;
    UInt16                minorVersion;
    UInt32                imagingMode;
    UInt32                imagingValidFlags;
    UInt32                correction;
    UInt32                quality;
    UInt32                directDraw;
    UInt32                imagingProperties[6];
    UInt32                reserved1;
    UInt32                reserved2;
} QTVRPanoImagingAtom, *QTVRPanoImagingAtomPtr;
```

**Node Location Atom Structure**

---

```
typedef struct QTVRNodeLocationAtom {
    UInt16                majorVersion;
    UInt16                minorVersion;
    OSType                nodeType;
    UInt32                locationFlags;
    UInt32                locationData;
    UInt32                reserved1;
    UInt32                reserved2;
} QTVRNodeLocationAtom, *QTVRNodeLocationAtomPtr;
```

**Node Header Atom Structure**

---

```
typedef struct QTVRNodeHeaderAtom {
    UInt16                majorVersion;
```

Summary of VR World and Node Atom Types

```

    UInt16                minorVersion;
    OSType                nodeType;
    QTAtomID              nodeID;
    QTAtomID              nameAtomID;
    QTAtomID              commentAtomID;
    UInt32                reserved1;
    UInt32                reserved2;
} QTVRNodeHeaderAtom, *QTVRNodeHeaderAtomPtr;

```

Hot Spot Information Atom Structure

---

```

typedef struct QTVRHotSpotInfoAtom {
    UInt16                majorVersion;
    UInt16                minorVersion;
    OSType                hotSpotType;
    QTAtomID              nameAtomID;
    QTAtomID              commentAtomID;
    Sint32                cursorID[3];
    Float32               bestPan;
    Float32               bestTilt;
    Float32               bestFOV;
    FloatPoint            bestViewCenter;
    Rect                  hotSpotRect;
    UInt32                flags;
    UInt32                reserved1;
    UInt32                reserved2;
} QTVRHotSpotInfoAtom, *QTVRHotSpotInfoAtomPtr;

```

Link Hot Spot Atom Structure

---

```

typedef struct QTVRLinkHotSpotAtom {
    UInt16                majorVersion;
    UInt16                minorVersion;
    UInt32                toNodeID;
    UInt32                fromValidFlags;
    Float32               fromPan;
    Float32               fromTilt;
    Float32               fromFOV;
    FloatPoint            fromViewCenter;
    UInt32                toValidFlags;
    Float32               toPan;
    Float32               toTilt;
    Float32               toFOV;
    FloatPoint            toViewCenter;
    Float32               distance;
    UInt32                flags;
    UInt32                reserved1;
    UInt32                reserved2;
} QTVRLinkHotSpotAtom, *QTVRLinkHotSpotAtomPtr;

```

Angle Range Atom Structure

---

```

typedef struct QTVRAngleRangeAtom {
    Float32               minimumAngle;
    Float32               maximumAngle;
}

```

Summary of VR World and Node Atom Types

```
} QTVRAngleRangeAtom, *QTVRAngleRangeAtomPtr;
```

**Panorama Sample Atom Structure**

---

```
typedef struct QTVRPanoSampleAtom {
    UInt16          majorVersion;
    UInt16          minorVersion;
    UInt32          imageRefTrackIndex;
    UInt32          hotSpotRefTrackIndex;
    Float32         minPan;
    Float32         maxPan;
    Float32         minTilt;
    Float32         maxTilt;
    Float32         minFieldOfView;
    Float32         maxFieldOfView;
    Float32         defaultPan;
    Float32         defaultTilt;
    Float32         defaultFieldOfView;
    UInt32          imageSizeX;
    UInt32          imageSizeY;
    UInt16          imageNumFramesX;
    UInt16          imageNumFramesY;
    UInt32          hotSpotSizeX;
    UInt32          hotSpotSizeY;
    UInt16          hotSpotNumFramesX;
    UInt16          hotSpotNumFramesY;
    UInt32          flags;
    UInt32          reserved1;
    UInt32          reserved2;
} QTVRPanoSampleAtom, *QTVRPanoSampleAtomPtr;
```

**Cubic View Atom Structure**

---

```
struct QTVRCubicViewAtom {
    Float32         minPan;
    Float32         maxPan;
    Float32         minTilt;
    Float32         maxTilt;
    Float32         minFieldOfView;
    Float32         maxFieldOfView;

    Float32         defaultPan;
    Float32         defaultTilt;
    Float32         defaultFieldOfView;
};
typedef struct QTVRCubicViewAtom    QTVRCubicViewAtom;
```

**Cubic Face Data Atom Structure**

---

```
struct QTVRCubicFaceData {
    float   orientation[4];
    float   center[2];
    float   aspect;
    float   skew;
};
```

Summary of VR World and Node Atom Types

```
typedef struct QTVRCubicFaceData QTVRCubicFaceData;
```

### Object Sample Atom Structure

---

```
typedef struct QTVRObjectSampleAtom {
    UInt16          majorVersion;
    UInt16          minorVersion;
    UInt16          movieType;
    UInt16          viewStateCount;
    UInt16          defaultViewState;
    UInt16          mouseDownViewState;
    UInt32          viewDuration;
    UInt32          columns;
    UInt32          rows;
    Float32         mouseMotionScale;
    Float32         minPan;
    Float32         maxPan;
    Float32         defaultPan;
    Float32         minTilt;
    Float32         maxTilt;
    Float32         defaultTilt;
    Float32         minFieldOfView;
    Float32         fieldOfView;
    Float32         defaultFieldOfView;
    Float32         defaultViewCenterH;
    Float32         defaultViewCenterV;
    Float32         viewRate;
    Float32         frameRate;
    UInt32          animationSettings;
    UInt32          controlSettings;
} QTVRObjectSampleAtom, *QTVRObjectSampleAtomPtr;
```

### Track Reference Entry Structure

---

```
struct QTVRTrackRefEntry {
    UInt32          trackRefType;
    UInt16          trackResolution;
    UInt32          trackRefIndex;
};
typedef struct QTVRTrackRefEntry QTVRTrackRefEntry;
```





# Profile Atom Guidelines

---

This appendix introduces and defines some of the ways that profile information about a QuickTime movie file can be summarized in a profile atom near the beginning of the file, so that software reading the file can easily determine some aspects of its features and complexity.

The information in this appendix should not be seen as a replacement for, or even a functional overlap with, the definition of the file-type atom. The file-type atom expresses which specifications a file is compatible with: reading software should not attempt to play files unless they are compatible with one or more specifications the reader implements, and should not refuse to play a file if it is marked as so compatible. However, reading software may use profiling information to issue warnings, request user decisions, and so on.

Reading software should not present excessive warnings to the user in the absence of summarized features. Additionally, readers are encouraged to try to play content even though crucial profile information is missing or incomplete.

Profiles may exist at the movie level or the track level. Track-level profiles summarize features of that track only. Movie-level profiles may summarize features across tracks or summarize features that are only relevant at the movie level (for example, the movie's maximum bitrate).

If the movie contains runtime variables that might affect a feature, such as the presence of alternate tracks that would affect the movie bit-rate, the affected feature should either be absent or report the worst case (for example, the highest bit-rate).

If a feature value cannot be accurately represented (for example, the value is not an integer, but the field is formatted as an integer) then the value should be rounded up to the nearest representable value.

## About This Appendix

---

The technical content of this appendix begins with a discussion of the structure of the profile atom, which holds an array of feature codes and values. Next is an enumeration of the currently included profile features, each described in a feature description section.

The responsibilities placed upon a writer of a movie (such as QuickTime or a consumer electronics (CE) device) are described in the feature's Writer Responsibilities section. A description of the algorithm to be used to calculate values is provided.

The feature's Reader Responsibilities section explains how reading software should interpret the value. In some cases, there are warnings to indicate how the reader must not use the value (for example, not interpreting the maximum bitrate value as the current bitrate).

## Profile Atom Specification

---

### Definition

---

Atom type

'prfl'

Container

Movie atom ('moov') or track atom ('trak')

Mandatory

No

Quantity

Zero or one

At the movie level, the profile atom must occur within the movie atom before the movie header atom. A reader may stop the search for the profile atom once the profile atom or the movie header atom is found. Because new atoms may be introduced into the movie atom (type 'moov') in the future, a reader must not expect the first child atom of the movie atom to be either the profile (type 'prfl') or the movie header ('mvhd') atom. This rule allows for new atoms in the future but still accommodates readers that do not want to perform an exhaustive enumeration of all the child atoms in a movie atom.

The profile atom expresses profiles or feature codes for features that occur in the movie. The list is not necessarily exhaustive, and there may be multiple profile values recorded for the same profile code. For example, if there are two independent sequences of MPEG-4 video in the movie, using different profile-level IDs, both might be recorded here.

Each feature is either universal or is documented in a specific specification, identified by a brand as used in the file type atom. The only brands that should occur in a given profile atom are the universal brand or brands that occur in the file type atom in the same file.

Feature value ranges should in general never include an unknown point; if the value of a feature is unknown, the feature should be absent from the profile atom.

Feature values should be deducible by fairly simple inspection of the rest of the movie: for example, extracting the profile-level ID from a video header, or calculations using information from the sample table (for example, overall average bitrate by summing the sample sizes and the sample durations). It is not appropriate to have features which cannot be computed, or only computed with difficulty (e.g. a buffer model estimation which requires emulating a video decoder on the entire bit stream). The algorithm to extract or deduce the feature value from the rest of the file must be defined.

Empty slots in the profile atom structure must be filled with zeroes.

Profile Atom Guidelines

If there are multiple parts of the file to which the same feature apply, yet they have different feature values, then either there must be entries for each occurrence or none at all. For example, if there are two MPEG-4 visual sequences, using different visual profiles, there are either two profile entries in the profile table (one for each sequence) or none at all. Features must not be partially documented.

Profile atoms may also occur at the track level. A track-level profile atom must occur within the track atom before the track header atom ('tkhd'). A reader should stop searching for a track's profile atom if either the profile or the track header atom is found, ignoring any other atoms present.

A track profile atom should only summarize features within that track. If track profile atoms exist, a movie profile atom can be built largely by copying feature entries from the profile atom of the movie's tracks to the profile atom at the movie level. It is possible to have multiple track profiles with different values which must be resolved to a single value for the movie as whole, however—such as multiple video tracks with different maximum bit rates—so not all features can be copied directly from the track to the movie profile. Additionally, the movie profile may summarize features that cannot occur at the track level, such as total movie bitrate.

When building a movie profile, you must include either all instances of a track-level feature or no instances of that feature. For example, if you have multiple video tracks that use different codecs, you must either include an entry at the movie level for each codec, or put no codec feature entries at the movie level at all.

**Figure F-1** The profile atom

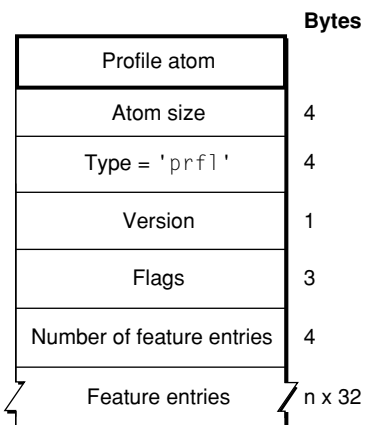

## Syntax

```
aligned(8) class ProfileAtom
    extends FullAtom('prfl') {
        unsigned int(32) feature-record-count;
        for (i=1; i<feature-record-count; i++) {
            unsigned int(32) reserved = 0;
            unsigned int(32) part-ID;
            unsigned int(32) feature-code;
            unsigned int(32) feature-value
        }
    }
```

## Semantics

---

reserved

A 32-bit field that must be set to zero.

part-ID

Either a brand identifier that occurs in the file-type atom of the same file, indicating a feature that is specific to this brand, or the value 0x20202020 (four ASCII spaces) indicating a universal feature that can be found in any file type that allows the profile atom. The value 0 is reserved for an empty slot.

feature-code

A four-character code either documented here (universal features), or in the specification identified by the brand. The value of 0 is reserved for an empty slot with no meaningful feature-value.

feature-value

Either a value from an enumerated set (for example, 1 or 0 for true or false, or an MPEG-4 profile-level ID) or a value that can be compared (for example, bitrate as an integer or dimensions as a 32-bit packed structure).

The profile atom is a full atom, so it has an 8-bit version and 24 bits of flags. For this specification, the version is 0 and the flags have the value 0. A reader compliant with this specification should treat any profile atom with a nonzero version value as if it did not exist.

**Figure F-2** Layout of a typical feature

	Bytes
Reserved = 0x00000000	4
Part ID = ' '(0x20202020)	4
Feature Code = 'avbr'	4
Value = 0x00000001	4

## Universal Features

---

A feature consists of four fields: a reserved field, which is set to zero; a part-ID, which specifies which brand the feature belongs to; a feature code, which identifies the feature; and a value field, which holds the feature value).

The part-ID can be either universal or brand-specific. Universal features have a part-ID of four ASCII spaces (0x20202020). Brand-specific features have a part-ID for a particular brand, which is taken from the Compatible\_brands field of the file type atom. Brand-specific features of QuickTime files have a part-ID of 'qt '. All features listed in this section are universal features; that is, they can be used in any file that includes a profile atom.

It is permissible to use the feature code of 0x00000000 as a placeholder, paired with a feature value of 0x00000000 for one or more features. Readers should simply ignore features having a feature code of zero.

No feature will exist to describe the unit of other features, such as bitrate. The device should consider the magnitude and tailor its display appropriately.

This specification describes only how features are stored in files. It does not require that the values of features be reported (for example, in a user interface) in the same manner as they are stored, or require that they be reported at all.

## Table of Features

Table F-1 (page 285) lists the universal features described in this appendix.

**Table F-1** Universal features

Brand	Code	Description	Profile Parent
0x20202020	mvbr	“Maximum Video Bitrate” (page 286)	Movie or Video Track
0x20202020	avvb	“Average Video Bitrate” (page 287)	Movie or Video Track
0x20202020	mabr	“Maximum Audio Bitrate” (page 288)	Movie or Track
0x20202020	avab	“Average Audio Bitrate” (page 289)	Movie or Audio Track
0x20202020	vfmt	“QuickTime Video Codec Type” (page 290)	Movie or Video Track
0x20202020	afmt	“QuickTime Audio Codec Type” (page 291)	Movie or Video Track
0x20202020	m4vp	“MPEG-4 Video Profile” (page 292)	Movie or Video Track
0x20202020	mp4v	“MPEG-4 Video Codec” (page 293)	Movie or Video Track
0x20202020	m4vo	“MPEG-4 Video Object Type” (page 294)	Movie or Video Track
0x20202020	mp4a	“MPEG-4 Audio Codec” (page 295)	Movie or Audio Track
0x20202020	mvsz	“Maximum Video Size in a Movie” (page 296)	Movie
0x20202020	tvsv	“Maximum Video Size in a Track” (page 298)	Movie or Video Track
0x20202020	vfps	“Maximum Video Frame Rate in a Single Track” (page 299)	Movie or Video Track
0x20202020	tafr	“Average Video Frame Rate in a Single Track” (page 300)	Movie or Video Track
0x20202020	vvfp	“Video Variable Frame Rate Indication” (page 301)	Movie or Video Track
0x20202020	ausr	“Audio Sample Rate for a Sample Entry” (page 302)	Movie or Audio Track
0x20202020	avbr	“Audio Variable Bitrate Indication” (page 303)	Movie or Audio Track

Brand	Code	Description	Profile Parent
0x20202020	achc	“Audio Channel Count” (page 304)	Movie or Audio Track

## Maximum Video Bitrate

---

Containing profile atom

Track (video), movie

Reserved

0x00000000

part-ID

0x20202020 (universal feature)

feature-code

'mvbr'

feature-value

Unsigned `int(32)` indicating maximum video bitrate in bits per second

### Feature Values

---

The value is an unsigned 32-bit integer indicating the maximum video bitrate in bits per second. The value may be larger than the actual video bitrate, so it should not be interpreted as a bitrate that will actually occur.

Example: 1 Mbps = 1000000.

### Writer Responsibilities

---

A writer of the maximum video bitrate should record a value that is equal to or greater than the actual bitrate for the video track. A writer (such as a CE device) may choose to record a constant value so long as that value is greater than or equal to the bitrate that may be encoded. It is also permitted to record a value set by the video encoder during initialization, so long as the value is never exceeded.

### Feature Value Algorithm

---

Apple recommends a sliding average over 1 second calculated from the sample tables.

If the feature is written for a newly encoded track (as by a CE device), it is permitted to record a value used to initialize the video encoder so long as the value is never exceeded. If the video track is edited and the maximum video bitrate recalculated, it may be calculated as a sliding average over 1 second, based on the sample table.

This can be calculated in the following manner:

1. For each sample, calculate the average 1-second bitrate; choose the shortest run of samples, including the candidate sample, that comprise 1 second or more of video, then divide the total data size of those samples by their total duration.

2. Choose the maximum value from the list of calculated 1-second averages.

## Reader Responsibilities

---

A reader of the maximum video bitrate feature value should compare the recorded value with its own limits to determine if the content can be played. The reader should not perform an equality comparison (=) but instead a relative comparison (<, <=, >, or >=).

The recorded value may be larger than the actual maximum video bitrate. Since this value may be an over-estimate, the reader should not use it as a basis for refusing to play the file, though a warning may be appropriate. To determine the actual bitrate, the reader may need to perform an inspection of the video track's sample table.

## Comments

---

The value of this feature should be deducible from information found in the sample table. Track edits must be considered in its calculation; if the track is edited, this value must be recalculated. Even though this value may exceed the actual maximum video bitrate, writers should attempt to minimize any over-estimation.

## Average Video Bitrate

---

Containing profile atom

Track (video), movie

part-ID

0x20202020 (universal feature)

feature-code

'avvb'

feature-value

Unsigned int(32) indicating average video bitrate in bits per second

## Feature Values

---

The value is an unsigned 32-bit integer indicating the average video bitrate in bits per second.

Example: 1 Mbps = 1000000.

## Writer Responsibilities

---

A writer of the average video bitrate feature should record a value that is equal to or greater than the average bitrate for the video track, measured across all media samples. A writer (such as a CE device) may choose to record a constant value so long as that value is greater than or equal to the average bitrate that may be encoded. It is also permitted to record a value set by the video encoder during initialization so long as the value equals or exceeds the average calculated from the resulting file.

## Feature Value Algorithm

---

Ideally, the long-term average: total sample sizes divided by total sample durations.

If the feature is written for a newly encoded track (as by a CE device), it is permitted to record a value used to initialize the video encoder. If the video track is edited and the average video bitrate recalculated, it may be calculated as an overall average based on the sample table.

## Reader Responsibilities

---

A reader of the average video bitrate feature value should compare the recorded value with its own limits to determine if the content can be played. The reader should not perform an equality comparison (=) but instead a relative comparison (<, <=, >, or >=).

Because a writer may record a larger value than the actual video bitrate, a reader should not interpret this as the actual video bitrate. To determine the current or actual bitrate, the reader may need to perform an inspection of the video track's sample table.

## Comments

---

The value of this feature should be deducible from information found in the sample table. Track edits must be considered in its calculation. Note that for highly variable bitrate video, the average rate may not be a typical rate.

## Maximum Audio Bitrate

---

Containing profile atom

Track (sound), movie

part-ID

0x20202020 (universal feature)

feature-code

'mabr'

feature-value

Unsigned `int(32)` indicating maximum audio bitrate in bits per second

## Feature Values

---

The value is an unsigned 32-bit integer indicating the maximum audio bitrate in bits per second that must be supported to guarantee playback of the audio. The actual maximum bitrate may be smaller, so a reader should not display this as the current bitrate.

Example: 128 kbps = 128000.



## Writer Responsibilities

---

A writer of the maximum audio bitrate feature should record a value that is equal to or greater than the current bitrate for the sound track. While the value may exceed the actual maximum bit-rate, the writer should attempt to minimize any over-estimation.

While recording the precise bitrate is preferred, it is not required. A writer (such as a CE device) may choose instead to record a constant value so long as that value is greater than or equal to the bitrate that may be encoded. It is also permitted to record a value set by the audio encoder during initialization so long as the value is never exceeded.

## Feature Value Algorithm

---

Apple recommends a sliding average over 1 second calculated from the sample tables.

If the feature is written for a newly encoded track (as by a CE device), it is permitted to record a value used to initialize the audio encoder so long as the value is never exceeded.

If the sound track is edited, and the audio bitrate is not constant, the maximum audio bitrate must be recalculated. Note that editing can change the duration of media samples, resulting in non-constant bitrate audio even when the sound track is encoded using a constant bitrate encoder. Maximum bitrate may be calculated as a sliding average over 1 second, based on the sample table. This can be calculated in the following manner:

1. For each sample, calculate the average 1-second bitrate; choose the shortest run of samples, including the candidate sample, that comprise 1 second or more of audio, then divide the total data size of those samples by their total duration.
2. Choose the maximum value from the list of calculated 1-second averages.

## Reader Responsibilities

---

A reader of this feature code should compare the recorded value with its own limits to determine if the content can be played. The reader should not perform an equality comparison (=) but instead a relative comparison (<, <=, >, or >=).

Because this value may be an over-estimate of the true maximum bitrate, the reader should not refuse to play a file on the basis of this value, although a warning may be appropriate. To determine the current or actual bitrate, the reader may need to perform an inspection of the video track's sample table.

## Average Audio Bitrate

---

Containing profile atom

Track (sound), movie

part-ID

0x20202020 (universal feature)

feature-code

'avab'

feature-value

Unsigned int(32) indicating average audio bitrate in bits per second

## Feature Values

---

The value is an unsigned 32-bit integer indicating the average audio bitrate in bits per second.

Example: 128 kbps = 128000.

## Writer Responsibilities

---

A writer of the average audio bitrate feature should record a value that is equal to or greater than the average bitrate for the sound track, measured across all media samples. A writer (such as a CE device) may choose to record a constant value so long as that value is greater than or equal to the average bitrate that may be encoded. It is also permitted to record a value set by the audio encoder during initialization so long as the value is never exceeded on average.

## Feature Value Algorithm

---

Normally, the long-term average: total sample sizes divided by total sample durations.

If the feature is written for a newly encoded track (as by a CE device), it is permitted to record a value used to initialize the audio encoder. If the sound track is edited and the average video bitrate recalculated, it may be calculated as an overall average based on the sample table.

## Reader Responsibilities

---

A reader of the average audio bitrate feature value should compare the recorded value with its own limits to determine if the content can be played. The reader should not perform an equality comparison (=) but instead a relative comparison (<, <=, >, or >=).

## Comments

---

The value of this feature should be deducible from information found in the sample table. Track edits normally need not be considered in the calculation for constant bitrate audio, but must be considered for variable bitrate audio or when track or movie segments containing constant bitrate audio are edited to alter their duration..

## QuickTime Video Codec Type

---

Containing profile atom

Track (video), movie

part-ID

0x20202020 (universal feature)

feature-code

'vfmt'

## Profile Atom Guidelines

feature-value

Unsigned int(32) (a four-character-code) holding the QuickTime video codec type copied from the ImageDescription structure's cType field

## Feature Values

---

This is the four-character-code found in a video sample description.

Examples: 'mp4v', 'jpeg'.

## Writer Responsibilities

---

A writer of the QuickTime video codec type feature should record the four-character code corresponding to the QuickTime video format type or types also recorded in the video track's sample descriptions.

**Note:** A writer that records the QuickTime Video Codec type for the 'mp4v' codec is encouraged also to write the MPEG-4 Video Profile feature.

## Feature Value Algorithm

---

The feature value is the video codec type read from a QuickTime ImageDescription's cType field. If there are multiple sample descriptions with different video codec types, multiple video codec type features should be recorded in the profile atom.

## Reader Responsibilities

---

A reader of this feature code should compare the recorded value by an equality comparison (using =) with the format codes supported by the reader.

## QuickTime Audio Codec Type

---

Containing profile atom

Track (sound), movie

part-ID

0x20202020 (universal feature)

feature-code

'afmt'

feature-value

Unsigned int(32) (a four-character-code) holding the QuickTime audio codec type copied from SoundDescription structure's dataFormat field

## Feature Values

---

This is the four-character-code found in a sound sample description.

Examples: 'mp4a', 'twos'.

## Writer Responsibilities

---

A writer of the QuickTime audio codec type feature should record the four-character-code corresponding to the QuickTime audio format type or types also recorded in the sound track's sample descriptions.

**Note:** A writer that records the QuickTime Audio Codec type for the 'mp4a' codec is encouraged also to write the MPEG-4 Audio Codec feature.

## Feature Value Algorithm

---

The feature value is the audio codec type read from a `SoundDescription` structure's `dataFormat` field. If there are multiple sample descriptions with different audio codec types, either all QuickTime Audio Codec Type features must be recorded in the profile atom or none must be recorded.

## Reader Responsibilities

---

A reader of this feature code should compare the recorded value by an equality comparison (using `=`) with the format codes supported by the reader.

## MPEG-4 Video Profile

---

Containing profile atom

Track (video), movie

part-ID

0x20202020 (universal feature)

feature-code

'm4vp'

feature-value

Unsigned `int(32)` where least significant 8 bits hold the `profile_and_level_indication` from the `visual_object_sequence`, as defined in specification ISO/IEC 14496-2, retrieved from the video parameters for the MPEG-4 video codec description. The top 24 bits must be set to 0.

## Feature Values

---

The least significant 8 bits hold the value. The most significant 24 bits of the feature value should be set to 0.

## Writer Responsibilities

---

A writer of the MPEG-4 video profile feature should record the 8 bits corresponding to the `profile_and_level_indication` from the `visual_object_sequence`, as defined in specification ISO/IEC 14496-2, found in the video parameters encoded in the esds of the MPEG-4 video codec sample description (with QuickTime codec type 'mp4v').

**Note:** A writer that records the MPEG-4 video profile feature is encouraged also to write the QuickTime Video Codec Type feature.

## Feature Value Algorithm

---

The feature value is the `profile_and_level_indication` from the `visual_object_sequence`, as defined in specification ISO/IEC 14496-2, retrieved from the video parameters for the MPEG-4 video codec description.

## Reader Responsibilities

---

A reader of this feature code should compare the recorded value with the set of profiles and levels supported by the reader.

## Comments

---

This feature may be present only if MPEG-4 video is used. Normally, the video codec type profile entry will also record that MPEG-4 video is present, unless no codec types are present (when, for example, an exhaustive list cannot be formed).

## MPEG-4 Video Codec

---

Containing profile atom

Track (video), movie

part-ID

0x20202020 (universal feature)

feature-code

'mp4v'

feature-value

Unsigned `int(32)` where the least significant 4 bits holds the `visual_object_type` as found in the `VisualObject` (as defined in specification ISO/IEC 14496-2, subclause 6.2.2) found in the esds of the MPEG-4 video codec (QuickTime type 'mp4v') sample description

## Feature Values

---

The least significant 4 bits hold the value. The most significant 28 bits of the feature value should be set to 0.

The list of visual object type constants is defined in specification ISO/IEC 14496-2, subclause 6.3.2.

Example: Video ID is indicated by the value 1.

## Writer Responsibilities

---

A writer of the MPEG-4 Video Codec feature should record the 4 bits corresponding to the `visual_object_type` found in the `VisualObject` within the `ES_descriptor's` `videoDecoderSpecificConfig`. The most significant 28 bits of the value should be set to 0.

**Note:** A writer that records the MPEG-4 Video Codec feature is encouraged also to write the QuickTime Video Codec Type feature.

## Feature Value Algorithm

---

The MPEG-4 video codec is the 4 bits of the `visual_object_type` found in the `VisualObject`. See ISO/IEC 14496-2, subclause 6.2.2. The `VisualObject` is found in the MPEG-4 Elementary Stream Descriptor Atom within the 'esds' sample description atom of the video sample description for the QuickTime video codec of type 'mp4v'.

## Reader Responsibilities

---

A reader of this feature code should compare the recorded value with the set of MPEG-4 video decoders supported by the reader.

## Comments

---

Because the QuickTime 'mp4v' codec may implement multiple video decoders defined in specification ISO/IEC 14496 in the future, this feature allows the reader to determine the specific video decoder needed to interpret the video bit-stream.

## MPEG-4 Video Object Type

---

Containing profile atom

Track (video), movie

part-ID

0x20202020 (universal feature)

feature-code

'm4vo'

feature-value

Unsigned int(32) where the least significant 8 bits hold the `video_object_type_indication` found in the `VideoObjectLayer` (Described in ISO/IEC 14496-2, subclause 6.2.3). The `VideoObjectLayer` is found in the MPEG-4 Elementary Stream Descriptor Atom within the 'esds' sample description atom of the video sample description for the QuickTime video codec of type 'mp4v'.

## Feature Values

---

The value is a video object type constant that indicates a set of video tools. The list of video object type constants is defined in specification ISO/IEC 14496-2, subclause 6.3.3. The least significant 8 bits hold the value. The most significant 24 bits should be set to 0.

Example: The Simple Object Type video object is indicated by the value 1.

## Writer Responsibilities

---

A writer of the MPEG-4 Video Object Type feature should record the 8 bits corresponding to the `video_object_type_indication` found in the `VideoObjectLayer` within the `ES_descriptor's` `video` `DecoderSpecificConfig`. The most significant 24 bits of the value should be set to 0. This feature should be written only for MPEG-4 video of video object type 1 (Video ID). If the MPEG-4 video does not use Video ID (1) for `visual_object_type`, the `esds` will have no `VideoObjectLayer` and consequently no `video_object_type_indication`. In this case, no MPEG-4 Video Object Type feature should be written.

**Note:** A writer that records the MPEG-4 Video Object Type feature for encoded video using the Video ID visual object type is encouraged to write the MPEG-4 Video Codec and MPEG-4 Video Profile features as well.

## Feature Value Algorithm

---

The MPEG-4 video object type is the least significant 8 bits of the `video_object_type_indication` found in the `VideoObjectLayer`. See ISO/IEC 14496-2, subclause 6.2.3. The `VideoObjectLayer` is found in the MPEG-4 Elementary Stream Descriptor Atom within the 'esds' sample description atom of the video sample description for the QuickTime video codec of type 'mp4v'.

## Reader Responsibilities

---

A reader of this feature code should compare the recorded value with the set of MPEG-4 video tools supported by the reader.

## MPEG-4 Audio Codec

---

Containing profile atom

Track (sound), movie

part-ID

0x20202020 (universal feature)

feature-code

'mp4a'

feature-value

Unsigned int(32) where least significant 5 bits hold the `AudioObjectType` as found in the `AudioSpecificInfo` (as defined in specification ISO/IEC 14496-3, subclause 1.6) found in the `esds` of the MPEG-4 audio codec (QuickTime type 'mp4a') sample description

## Feature Values

---

The least significant 5 bits hold the value. The most significant 27 bits of the feature value should be set to 0.

The list of audio object type constants is defined in specification ISO/IEC 14496-3, subclause 1.5.1.1.

Examples: AAC LC is indicated by the value 2, CELP is indicated by the value 8.

## Writer Responsibilities

---

A writer of the MPEG-4 Audio Codec feature should record the 5 bits corresponding to the `AudioObjectType` found in the `ES_descriptor's audioDecoderSpecificConfig`. The most significant 27 bits of the value should be set to 0.

**Note:** A writer that records the MPEG-4 Audio Codec feature is encouraged also to write the QuickTime Audio Codec Type feature.

## Feature Value Algorithm

---

The MPEG-4 audio codec value is the 5 bits of the `AudioObjectType` found in the `AudioSpecificInfo` (a `DecoderSpecificInfo`). See specification ISO/IEC 14496, subclause 1.6. The `AudioSpecificInfo` is found in the MPEG-4 Elementary Stream Descriptor Atom within the `siDecompressionParam` atom of the audio sample description for the QuickTime audio codec of type 'mp4a'.

## Reader Responsibilities

---

A reader of this feature code should compare the recorded value with the set of MPEG-4 audio decoders supported by the reader.

## Comments

---

Because the QuickTime 'mp4a' codec may implement multiple audio decoders defined in specification ISO/IEC 14496 in the future, this feature allows the reader to determine the specific audio decoder needed to interpret the audio bit stream. The MPEG-4 Audio Codec feature should be present only if the 'mp4a' audio codec is used in a sound track.

## Maximum Video Size in a Movie

---

Containing profile atom

Movie

part-ID

0x20202020 (universal feature)

feature-code

'mvsz'



feature-value

A 32-bit packed structure holding width and height of the largest bounds needed to display the movie

## Feature Values

---

A packed structure in a 32-bit value:

```
struct {
    unsigned integer(16) width;
    unsigned integer(16) height;
};
```

In big-endian order, the top 16 bits correspond to the width. The lower 16 bits correspond to the height.

## Writer Responsibilities

---

A writer of the Maximum Movie Video Size feature should record a value that is equal to or greater than the display size needed by the movie—the actual width and height needed to display the movie at its normal size, taking into account all matrices (all track matrices and the movie matrix).

A writer (such as a CE device) may choose to record a constant size based upon its current recording mode even if the actual size recorded in the movie is smaller.

## Feature Value Algorithm

---

This value is calculated by examining the dimensions of all visual tracks and computing the maximum combined dimensions, including the effect of track matrices and the movie matrix. For example, if two video tracks play side-by-side in the movie, and the tracks and movie all use the identity matrix, this value will be the largest of the two tracks' heights and their combined width.

## Reader Responsibilities

---

A reader of this feature code should compare the recorded value with its own video size limits.

The reader should not interpret the value of this feature as the current video size. To determine the current video size, the reader should use the dimensions of all currently displaying video tracks, their matrices, and the movie matrix.

## Comments

---

The width and height correspond to the maximum visual area needed to display the movie.

The summarized width and height should take into account all components of all track matrices and the movie matrix. The goal is to understand the maximum contribution of all tracks to the movie's bounds.

For the case where there is a single video track with an identity track matrix, the movie's maximum video size feature would typically have the same value as the track's maximum video size feature.

## Maximum Video Size in a Track

---

Containing profile atom

Track (video), movie

part-ID

0x20202020 (universal feature)

feature-code

'tvsz'

feature-value

A 32-bit packed structure holding width and height of the largest picture buffer needed for a video track.

### Feature Values

---

A packed structure in a 32-bit value:

```
struct {
    unsigned integer(16) width;
    unsigned integer(16) height;
};
```

In big-endian order, the top 16 bits correspond to the width. The lower 16 bits correspond to the height.

### Writer Responsibilities

---

A writer of the Maximum Track Video Size feature should record a value that is equal to or greater than the largest height and width of any sample description in the video track. This does not include the effect of any scaling or offset applied by the track matrix and may not be the same as the track height and track width.

A writer (such as a CE device) may choose to record a constant size based upon its current recording mode even if the actual size recorded in the track is smaller.

### Feature Value Algorithm

---

Examine all sample descriptions for the track, and use the maximum width and maximum height found in any sample. The maximum width and maximum height may come from independent sample descriptions.

### Reader Responsibilities

---

A reader of this feature code should compare the recorded value with its own image buffer limits.

The reader should not interpret the value of this feature as the current video size. To determine the current video size, the reader should use the dimensions of all currently displaying video tracks, their matrices, and the movie matrix.

## Comments

---

The width and height correspond to the largest image buffer dimensions needed for a visual track. When present in a movie-level profile, these atoms document the maximum video size found in each of the movie's tracks.

The summarized width and height do not take into account any scaling or translation caused by the track or movie matrices, and are not necessarily the same as the track height and width.

For the case where there is a single video track with an identity track and matrix and an identity movie matrix, the movie's maximum video size feature would have the same value as the track's feature.



**Warning:** Use of the "clean aperture" sample description extension does not affect the value of the track visual size, as the picture buffer is needed immediately after decoding, prior to any clean aperture clipping.

## Maximum Video Frame Rate in a Single Track

---

Containing profile atom

Track (video), movie

part-ID

0x20202020 (universal feature)

feature-code

'vfps'

feature-value

An unsigned fixed-point (16.16) number holding the maximum video frame rate

### Feature Values

---

This is an unsigned fixed-point (16.16) number holding the maximum video frame rate. The integer portion of the number can range from 0 to 65535.

Examples: 25 fps = 0x00190000; 24 fps = 0x00180000; 29.97 = 0x001DF853 (close approximation of a 30000/1001 ratio). The value may be rounded up to the nearest integer.

### Writer Responsibilities

---

A writer of the Maximum Video Frame Rate feature should record a 16.16 fixed-point value that is equal to or greater than the current video frame rate. A writer (such as a CE device) may choose to record a constant for the feature based on its current recording mode, even if the actual frame rate is less.

A writer of a new video track (such as a CE device recorder) may set the maximum frame rate feature value to a value set during video encoder initialization, so long as this frame rate is never exceeded.

If the current calculated frame rate is fractional (such as 22.3 fps), a writer may choose to round the value up to the nearest integer value (such as 23.0 fps for 22.3 fps).

A writer calculating the video frame rate using the video track's sample table should not consider the first or the last sample duration if they differ from the other sample durations. The reason for this is that captured movie files often have longer or shorter first and last sample durations. By not considering them in the calculation, a more accurate calculation is achieved.

## Feature Value Algorithm

---

This feature value may be calculated as the inverse of the smallest sample duration in the video track or tracks.

If the value is written for a newly recorded video track it may be a value established during initialization of the video encoder, so long as the frame rate is not exceeded.

## Reader Responsibilities

---

A reader of this feature code should compare the recorded value with its own video frame rate limits. It should not expect exact values.

The reader should not interpret the value of this feature as the current frame rate. To determine the current frame rate, the reader should use the video track's sample table.

## Comments

---

A writer may choose to round up any fractional value of the fixed-point number to the nearest 16-bit integer leaving the lower 16 bits of the Fixed value set to 0. So, in the case of the 29.97 approximation of 0x001DF853, the writer could round this up to 0x001E0000 (which equals 30).

## Average Video Frame Rate in a Single Track

---

Containing profile atom

Track (video), movie

part-ID

0x20202020 (universal feature)

feature-code

'tafr'

feature-value

An unsigned fixed-point (16.16) number holding the average video frame rate

## Feature Values

---

This is an unsigned fixed-point (16.16) number holding the average video frame rate. The integer portion of the number can range from 0 to 65535.

Examples: 25 fps = 0x00190000; 24 fps = 0x00180000; 29.97 = 0x001DF853 (close approximation of a 30000/1001 ratio). The value may be rounded up to the nearest integer.

When present in a movie-level profile, these atoms document the average video frame rate of each track in the movie.

## Writer Responsibilities

---

A writer of the Average Video Frame Rate feature should record a 16.16 fixed-point value that is equal to or greater than the average video frame rate. A writer (such as a CE device) may choose to record a constant for the feature based on its current recording mode, even if the actual frame rate is less.

A writer of a new video track (such as a CE device recorder) may set the average frame rate feature value to a value set during video encoder initialization, so long as this frame rate is not exceeded by the actual average, as determined by the feature value algorithm described below.

If the average calculated frame rate is fractional (such as 22.3 fps), a writer may choose to round the value up to the nearest integer value (such as 23.0 fps for 22.3 fps).

## Feature Value Algorithm

---

This feature value is calculated by dividing the the total number of frames (samples) by the duration of the track. It is permissible to omit the first and last frames from this calculation, as they may have significantly different duration than the average.

## Reader Responsibilities

---

A reader of this feature code should understand that each frame is a video sample with its own independent and explicit duration. While it is possible for all frames to have the same duration, it is equally possible for the duration of any frame to be radically different from any other. Therefore, the average frame rate may not always be meaningful information.

The reader should not interpret the value of this feature as the current frame rate. To determine the current frame rate, the reader should use the video track's sample table.

## Comments

---

A writer may choose to round up any fractional value of the fixed-point number to the nearest 16-bit integer leaving the lower 16 bits of the Fixed value set to 0. So, in the case of the 29.97 approximation of 0x001DF853, the writer could round this up to 0x001E0000 (which equals 30).

## Video Variable Frame Rate Indication

---

Containing profile atom

Track (video), movie

part-ID

0x20202020 (universal feature)

feature-code

'vvp'

feature-value

Unsigned `int(32)` holding the value 0 if the frame rate is constant or the value 1 if the frame durations vary

## Feature Values

---

The feature value holds one of the following two values: 0 if all video samples have the same display duration, or 1 if any video samples vary in duration.

## Writer Responsibilities

---

A writer of the Video Variable Frame Rate Indication feature should compare the video track sample durations. If all considered durations have the same value, the value 0 indicating constant frame rate should be recorded. If any durations differ, the value 1 should be recorded for the feature. No other value should be recorded.

## Feature Value Algorithm

---

If the Time to Sample table records a constant duration for all samples, then record 0, else record 1.

## Reader Responsibilities

---

A reader of this feature code should only expect the values 0 or 1.

## Audio Sample Rate for a Sample Entry

---

Containing profile atom

Track (sound), movie

part-ID

0x20202020 (universal feature)

feature-code

'ausr'

feature-value

Unsigned `int(32)` holding the audio sample rate in units per second (for example, 44100 for 44.1 kHz)

## Feature Values

---

This feature value is an unsigned 32-bit integer holding the audio sample rate in units per seconds (cycles per second). The value should be rounded up to the nearest integer if it has a fractional portion.

Examples: 24 kHz = 24000, 44.1 kHz = 44100.

## Writer Responsibilities

---

A writer of the Audio Sample Rate feature should record the integer portion (rounded up if there is a fractional portion) of the audio sample rate found in a sound track's `SoundDescription` structure.

If multiple audio sample rates are used in the movie, then either all must be recorded in the profile atom, or none must be recorded.

## Feature Value Algorithm

---

This is the integer portion of the sample rate from a QuickTime audio sample description (rounded up if there is a fractional portion). If the sample rate is greater than 64 kHz, the integer portion can be recorded here.

If a sample rate has a fractional portion, the writer should round up to the nearest integer. So, the 22254.54545 value that may occur in QuickTime audio as a Fixed value represented as 0x56EE8BA3 can be recorded as 22255.

## Reader Responsibilities

---

A reader of this feature code should compare the recorded value with its own audio sample rate limits. If the reader only supports discrete values (such as 44100), it can perform equality comparisons (=). If the reader supports ranges of audio sample rates (such as all rates less than or equal to 32000), the reader can perform relative comparisons (<, <=, >, or >=).

## Audio Variable Bitrate Indication

---

Containing profile atom

Track (sound), movie

part-ID

0x20202020 (universal feature)

feature-code

'avbr'

feature-value

Unsigned int(32) holding the value 0 if the audio is constant bitrate or 1 if the audio is variable bitrate

## Feature Values

---

The feature value holds one of the following two values: 0 if the audio is constant bitrate, or 1 if the audio is variable bitrate.

## Writer Responsibilities

---

A writer of the Audio Variable Bitrate Indication feature should determine if the audio frames are constant or variable bitrate in nature and record either 0 or 1, respectively.

## Feature Value Algorithm

---

Consult the audio sample descriptions. If the `compressionID` field in the sample descriptions is 0 or -1, then the audio is constant bitrate. If the field is -2, then the same algorithm as for video applies: if all the samples have both constant duration and constant size, then the audio is constant bit-rate; otherwise is it variable.

## Reader Responsibilities

---

A reader of this feature code should only expect the values 0 or 1.

## Audio Channel Count

---

Containing profile atom

Track (sound), movie

part-ID

0x20202020 (universal feature)

feature-code

'achc'

feature-value

Unsigned `int(32)` holding the number of audio channels

## Feature Values

---

The feature value is an unsigned 32-bit integer holding the number of audio channels encoded by a Sound Track in the movie. For monaural, the value would be 1. For stereo, the value would be 2. Note that the audio channel count is a standard field in the sound sample description.

## Writer Responsibilities

---

A writer of the Audio Channel Count feature should determine the number of audio channels encoded in the sound track or tracks of the movie.

## Feature Value Algorithm

---

Consult the audio sample descriptions.

## Reader Responsibilities

---

The reader should be prepared to either play the specified number of channels or to map the audio to the number of channels the reader supports (for example, mixing down stereo sound for a monaural speaker).



# Document Revision History

This table describes the changes to *QuickTime File Format Specification*.

Date	Notes
2007-09-04	First public release of complete, updated <i>QuickTime File Format Specification</i> with information about atoms and atom types. Added licensing information and disclaimer for developers. Modified introductory sections and atom descriptions; updated artwork and edited for technical accuracy.
	A QuickTime file may now contain a file type compatibility atom. See <a href="#">“The File Type Compatibility Atom”</a> (page 30). A movie atom may now contain a movie profile atom. See <a href="#">“The Movie Profile Atom”</a> (page 37). A track atom may now contain a track profile atom. See <a href="#">“Track Profile Atom”</a> (page 48). Video sample descriptions may now contain a pixel aspect ratio atom for non-square pixels. See <a href="#">“Pixel Aspect Ratio ('pasp)’”</a> (page 103). Video sample descriptions may now also contain a color parameter atom. See <a href="#">“Color Parameter Atoms ('colr)’”</a> (page 105). Video sample descriptions may now a clean aperture atom. See <a href="#">“Clean Aperture ('clap)’”</a> (page 110). The sound description record has been expanded to represent variable bit-rate compression more accurately. See <a href="#">“Sound Sample Descriptions”</a> (page 117). The section describing MPEG-4 audio has been modified. See <a href="#">“MPEG-4 Audio”</a> (page 125).
	It is now recommended that the file creation and modification times be set using UTC, rather than local time zones. See <a href="#">“Calendar Date and Time Values”</a> (page 222). User data text may now be encoded using either Macintosh text encoding or ISO text encoding (Unicode). See <a href="#">“User Data Text Strings and Language Codes”</a> (page 45). MPEG-4 video and audio sample descriptions may now contain elementary stream descriptor atoms. See <a href="#">“MPEG-4 Elementary Stream Descriptor Atom ('esds)’”</a> (page 104) and <a href="#">“MPEG-4 Elementary Stream Descriptor ('esds') Atom”</a> (page 123). It is now possible to specify languages using either Macintosh language codes or ISO language codes. See <a href="#">“Language Code Values”</a> (page 219).

# REVISION HISTORY

Document Revision History

# Glossary

---

**alpha channel** The upper bits of a display pixel, which control the blending of video and graphical image data for a video digitizer component.

**alternate track** A movie track that contains alternate data for another track. QuickTime chooses one track to be used when the movie is played. The choice may be based on such considerations as image quality or localization. See also [track](#).

**API (Application Programming Interface)** The set of function calls, data structures, and other programming elements by which a structure of code (such as a system-level toolbox) can be accessed by other code (such as an application program).

**atom** The basic unit of data in a movie resource, sprite, or other QuickTime data structure. There are a number of different atom types, including movie atoms, track atoms, and media atoms. There are two varieties of atoms: QT atoms, which may contain other atoms, and classic atoms, which do not contain any other atoms. See also [movie resource](#), [sprite](#), [QT atom](#), and [classic atom](#).

**atom container** A tree-structured hierarchy of QT atoms. See also [QT atom](#).

**atom ID** A 32-bit integer that uniquely identifies an atom among other child atoms of the same parent atom. The root atom has an atom ID value of 0x0001. See also [child atom](#), [parent atom](#), and [root atom](#).

**atom type** A 32-bit value that uniquely identifies the data type of an atom. It is normally an OSType, rendered by four ASCII characters. An atom's data type helps determine how the atom's contents are interpreted.

**background color** The color of the background behind a sprite or other image.

**bit depth** The number of bits used to encode the color of each pixel in a graphics buffer.

**chapter list** A set of named entry points into a movie, presented to the viewer as a text list.

**child atom** A QT atom inside a container atom, which is its parent atom. See also [QT atom](#), [container atom](#), and [parent atom](#).

**chunk** A collection of sample data in a media. Chunks, which may contain one or more samples, allow optimized data access. Chunks in a media may have different sizes, and the samples within a chunk may have different sizes.

**classic atom** A QuickTime atom that contains no other atoms. A classic atom, however, may contain a table. An example of a classic atom is an edit list atom, containing the edit list table. Compare [QT atom](#).

**clipped movie boundary region** The region that combines the union of all track movie boundary regions for a movie, which is the movie's movie boundary region, with the movie's movie clipping region, which defines the portion of the movie boundary region that is to be used. See also [movie boundary region](#) and [movie clipping region](#).

**clipping** The process of defining the boundaries of a graphics area.

**container atom** An atom that contains other atoms, possibly including other container atoms.

**creator signature** In the Macintosh file system, a four-character code that identifies the application program to which a file belongs.

**data fork** In a Macintosh file, the section that corresponds to a DOS/Windows file.

**data handler** A piece of software that is responsible for reading and writing a media's data. The data handler provides data input and output services to the media's media handler. See also [media handler](#).

**data reference** A reference to a media's data.

**display coordinate system** The QuickDraw graphics world, which can be used to display QuickTime movies, as opposed to the movie's time coordinate system, which defines the basic time unit for each of the movie's tracks. Compare [time coordinate system](#).

**dithering** A technique used to improve picture quality when you are attempting to display an image that exists at a higher bit-depth representation on a lower bit-depth device. For example, you might want to dither a 24 bits per pixel image for display on an 8-bit screen.

**dropframe** A synchronizing technique that skips timecodes to keep them current with video frames.

**duration** A time interval. Durations are time values that are interpreted as spans of time, rather than as points in time.

**edit list** A data structure that arranges a media into a time sequence.

**edit state** Information defining the current state of a movie or track with respect to an edit session. QuickTime uses edit states to support undo facilities.

**effect description** A data structure that specifies which component will be used to implement an effect in a movie, and how the component will be configured.

**effect track** A modifier track that applies an effect (such as a wipe or dissolve) to a movie. See [modifier track](#).

**file fork** A section of a Macintosh file. See also [data fork](#), [resource fork](#).

**file preview** A thumbnail picture from a movie that is displayed in the Open File dialog box. See also [thumbnail picture](#).

**fixed point** A point that uses fixed-point numbers to represent its coordinates. QuickTime uses fixed points to provide greater display precision for graphical and image data.

**fixed rectangle** A rectangle that uses fixed points to represent its vertices. QuickTime uses fixed rectangles to provide greater display precision.

**Flash** A vector-based graphics and animation technology. Flash data is exported by SWF files.

**flattening** The process of copying all of the original data referred to by reference in QuickTime tracks into a QuickTime movie file. This can also be called resolving references. Flattening is used to bring in all of the data that may be referred to from multiple files after QuickTime editing is complete. It makes a QuickTime movie stand-alone—that is, it can be played on any system without requiring any additional QuickTime movie files or tracks, even if the original file referenced hundreds of files. The flattening operation is essential if QuickTime movies are to be used with CD-ROM discs.

**frame** A single image in a sequence of images.

**frame rate** The rate at which a movie is displayed—that is, the number of frames per second that are actually being displayed. In QuickTime the frame rate at which a movie was recorded may be different from the frame rate at which it is displayed. On very fast machines, the playback frame rate may be faster than the record frame rate; on slow machines, the playback frame rate may be slower than the record frame rate. Frame rates may be fractional.

**free atom** An atom of type 'free', which you can include in a QuickTime file as a placeholder for unused space.

**file type atom** An atom of type 'ftyp', which defines which file specifications a file is compatible with.

**graphics mode** The method by which two overlapping images are blended together to produce a composite image.

**graphics world** A software environment in which a movie track or set of images may be defined before importing them into a movie.

**handler reference atom** A QT atom of type 'hdlr' that specifies the media handler to be used to interpret a media. See also [QT atom](#), [media](#), [media handler](#).

**hint track** A track in a streaming movie that contains information for a packetizer about the data units to stream. See also [streaming](#).

**hot spot** An area, typically in a VR presentation, that the user can click to invoke an action.

**hypertext** Action media that contains a URL and takes the user to a website.

**identity matrix** A transformation matrix that specifies no change in the coordinates of the source image. The resulting image corresponds exactly to the source image. See also [transformation matrix](#).

**image** In sprite programming, one of a sprite's properties. See also [sprite](#), [property](#).

**image sequence** A series of visual representations usually represented by video over time. Image sequences may also be generated synthetically, such as from an animation sequence.

**image track** Any track in a QuickTime movie that contains visual images. The term particularly applies to video tracks that contain VR data.

**input map** A data structure that describes where to find information about tracks that are targets of a modifier track. See [modifier track](#).

**interlacing** A video mode that updates half the scan lines on one pass and goes through the second half during the next pass.

**interleaving** A technique in which sound and video data are alternated in small pieces, so the data can be read off disk as it is needed. Interleaving allows for movies of almost any length with little delay on startup.

**ISO** Acronym for the International Standards Organization. ISO establishes standards for multimedia data formatting and transmission, such as JPEG and MPEG.

**Joint Photographic Experts Group (JPEG)** Refers to an international standard for compressing still images. This standard supplies the algorithm for image compression. The version of JPEG supplied with QuickTime complies with the baseline ISO standard bitstream, version 9R9. This algorithm is best suited for use with natural images.

**key frame** A sample in a sequence of temporally compressed samples that does not rely on other samples in the sequence for any of its information. Key frames are placed into temporally compressed sequences at a frequency that is determined by the key frame rate. Typically, the term key frame is used with respect to temporally compressed sequences of image data. See also [sync sample](#). See also [key frame rate](#).

**key frame rate** The frequency with which key frames are placed into temporally compressed data sequences. See also [key frame](#).

**leaf atom** An atom that contains only data, and no other atoms.

**layer** A mechanism for prioritizing the tracks in a movie or the overlapping of sprites. When it plays a movie, QuickTime displays the movie's tracks according to their layer—tracks with lower layer numbers are displayed first; tracks with higher layer numbers are displayed over those tracks.

**matrix** See [transformation matrix](#).

**matte** A defined region of a movie display that can be clipped and filled with another display.

**media** A data structure that contains information that describes the data for a track in a movie. Note that a media does not contain its data; rather, a

media contains a reference to its data, which may be stored on disk, CD-ROM disc, or any other mass storage device. Also called a *media structure*.

**media handler** A piece of software that is responsible for mapping from the movie's time coordinate system to the media's time coordinate system. The media handler also interprets the media's data. The data handler for the media is responsible for reading and writing the media's data. See also [data handler](#).

**MIDI** Acronym for Musical Instrument Digital Interface, a standard format for sending instructions to a musical synthesizer.

**modifier track** A track in a movie that modifies the data or presentation of other tracks. For example, a tween track is a modifier track. See also [tween track](#).

**movie** A structure of time-based data that is managed by QuickTime. A movie may contain sound, video, animation, or a combination of any of these types of data. A QuickTime movie contains one or more tracks; each track represents a single data stream in the movie. See also [time-based data, track](#).

**movie boundary region** A region that describes the area occupied by a movie in the movie coordinate system, before the movie has been clipped by the movie clipping region. A movie's boundary region is built up from the track movie boundary regions for each of the movie's tracks. See also [movie clipping region](#), [track movie boundary region](#).

**movie clipping region** The clipping region of a movie in the movie's coordinate system. QuickTime applies the movie's clipping region to the movie boundary region to obtain a clipped movie boundary region. Only that portion of the movie that lies in the clipped movie boundary region is then transformed into an image in the display coordinate system. See also [movie boundary region](#).

**movie display boundary region** A region that describes the display area occupied by a movie in the display coordinate system, before the movie has been clipped by the movie display clipping region. See also [movie display clipping region](#).

**movie display clipping region** The clipping region of a movie in the display coordinate system. Only that portion of the movie that lies in the clipping region is visible to the user. QuickTime applies the movie's display clipping region to the movie display boundary region to obtain the visible image. See also [movie display boundary region](#).

**movie file** A QuickTime file that stores a movie and its associated data.

**movie header atom** A QT atom that specifies the characteristics of an entire QuickTime movie.

**movie poster** A single visual image representing a QuickTime movie. You specify a poster as a point in time in the movie and specify the tracks that are to be used to constitute the poster image.

**movie preview** A short dynamic representation of a QuickTime movie. Movie previews typically last no more than 3 to 5 seconds, and they should give the user some idea of what the movie contains. You define a movie preview by specifying its start time, its duration, and its tracks.

**movie resource** One of several data structures that provide the medium of exchange for movie data between applications on a Macintosh computer and between computers, even computers of different types.

**movie sprite** A sprite that lives in a sprite track and acts in a movie. See also [sprite track](#).

**MPEG-4** An ISO standard (based on the QuickTime file format) that supports video and audio streaming. See also [streaming](#).

**music** One of the QuickTime media types, in which sequences of sounds and tones are generated.

**National Television System Committee (NTSC)** Refers to the color-encoding method adopted by the committee in 1953. This standard was the first monochrome-compatible, simultaneous color transmission system used for public broadcasting. This method is used widely in the United States.

**node** Either a panorama or an object in a QuickTime VR movie.

**NTSC** See National Television System Committee.

**object track** A track in a QuickTime VR movie that contains a set of views of a VR object.

**offset-binary encoding** A method of digitally encoding sound that represents the range of amplitude values as an unsigned number, with the midpoint of the range representing silence. For example, an 8-bit sound sample stored in offset-binary format would contain sample values ranging from 0 to 255, with a value of 128 specifying silence (no amplitude). Samples in Macintosh sound resources are stored in offset-binary form. Compare [twos-complement encoding](#).

**PAL** See [Phase Alternation Line \(PAL\)](#).

**panorama** A structure of QuickTime VR data that forms a virtual-world environment within which the user can navigate.

**panorama track** A track in a QuickTime VR movie that contains a panorama.

**parent atom** A QT atom that contains other QT atoms, which are its child atoms. See also [child atom](#).

**Phase Alternation Line (PAL)** A color-encoding system used widely in Europe, in which one of the subcarrier phases derived from the color burst is inverted in phase from one line to the next. This technique minimizes hue errors that may result during color video transmission. Sometimes called Phase Alternating Line.

**playback quality** A relative measure of the fidelity of a track in a QuickTime movie. You can control the playback (or language) quality of a movie during movie playback. QuickTime chooses tracks from alternate tracks that most closely correspond to the display quality desired. See also [alternate track](#).

**poster** A frame shot from a movie, used to represent its content to the user.

**preferred rate** The default playback rate for a QuickTime movie.

**preferred volume** The default sound volume for a QuickTime movie.

**preview** A short, potentially dynamic, visual representation of the contents of a file. The Standard File Package can use previews in file dialog boxes to give the user a visual cue about a file's contents. See also [file preview](#).

**preview atom** An atom of type 'pnot', which can appear in a QuickTime file to contain a movie's file preview.

**profile atom** An atom of type 'prfl', which summarizes the features of a movie or track.

**property** Information about a sprite that describes its location or appearance. One sprite property is its image, the original bitmapped graphic of the sprite.

**QT atom** A QuickTime atom that contains other atoms, possibly including other QT atoms and classic atoms. A data reference atom is an example of a QT atom. Compare [classic atom](#).

**QTMA (QuickTime Music Architecture)** The part of QuickTime that lets other code create and manipulate music tracks in movies.

**QTVR track** A track in a QuickTime movie that maintains a list of VR nodes.

**QuickDraw** The original Mac OS two-dimensional drawing software, used by QuickTime.

**QuickTime** A set of Macintosh system extensions or a Windows dynamic-link library that other code can use to create and manipulate time-based data.

**QuickTime VR** A QuickTime media type that lets users interactively explore and examine photorealistic three-dimensional virtual worlds. QuickTime VR data structures are also called panoramas.

**rate** A value that specifies the pace at which time passes for a time base. A time base's rate is multiplied by the time scale to obtain the number



of time units that pass per second. For example, consider a time base that operates in a time coordinate system that has a time scale of 60. If that time base has a rate of 1, 60 time units are processed per second. If the rate is set to 1/2, 30 time units pass per second. If the rate is 2, 120 time units pass per second. See also [time base](#) and [time unit](#).

**resource** In Macintosh programming, an entity in a file or in memory that may contain executable code or a description of a user interface item. Resources are loaded as needed by a resource manager, and are identified by their type and ID number.

**resource fork** In a Macintosh file, the section that contains resources.

**root atom** The largest atom container in a hierarchy, with atom type 'sean'.

**sample** A single element of a sequence of time-ordered data.

**sample format** The format of data samples in a track, such as a sprite track.

**sample number** A number that identifies the sample with data for a specified time.

**SECAM (Systeme Electronique Couleur avec Memoire)** Sequential Color With Memory; refers to a color-encoding system in which the red and blue color-difference information is transmitted on alternate lines, requiring a one-line memory in order to decode green information.

**single-fork movie file** A QuickTime movie file that stores both the movie data and the movie resource in the data fork of the movie file. You can use single-fork movie files to ease the exchange of QuickTime movie data between Macintosh computers and other computer systems. Compare [movie file](#).

**skip atom** An atom of type 'skip', which you can include in a QuickTime file as a placeholder for unused space.

**SMPTE** Acronym for Society of Motion Picture and Television Engineers, an organization that sets video and movie technical standards.

**sprite** An animated image that is managed by QuickTime. A sprite is defined once and is then animated by commands that change its position or appearance.

**sprite track** A movie track populated by movie sprites.

**streaming** Delivery of video or audio data over a network in real time, to support applications such as videophone and video conferencing. See [MPEG-4](#).

**string atom** An atom in VR media that contains text.

**SWF files** Files that contain Flash data. See [Flash](#).

**sync sample** A sample that does not rely on preceding frames for content. See also [key frame](#).

**Systeme Electronique Couleur avec Memoire** See SECAM.

**temporal compression** Image compression that is performed between frames in a sequence. This compression technique takes advantage of redundancy between adjacent frames in a sequence to reduce the amount of data that is required to accurately represent each frame in the sequence. Sequences that have been temporally compressed typically contain key frames at regular intervals.

**thumbnail picture** A picture that can be created from an existing image that is stored as a pixel map, a picture, or a picture file. A thumbnail picture is useful for creating small representative images of a source image and in previews for files that contain image data.

**time base** A set of values that define the time basis for an entity, such as a QuickTime movie. A time base consists of a time coordinate system (that is, a time scale and a duration) along with a rate value. The rate value specifies the speed with which time passes for the time base.

**time-based data** Data that changes or interacts with the user along a time dimension. QuickTime is designed to handle time-based data.



**timecode media** A media of type 'tmcd' that is used to store timecode data.

**timecode track** A movie track that stores external timing information, such as SMPTE timecodes.

**time coordinate system** A set of values that defines the context for a time base. A time coordinate system consists of a time scale and a duration. Together, these values define the coordinate system in which a time value or a time base has meaning.

**time scale** The number of time units that pass per second in a time coordinate system. A time coordinate system that measures time in sixtieths of a second, for example, has a time scale of 60.

**time unit** The basic unit of measure for time in a time coordinate system. The value of the time unit for a time coordinate system is represented by the formula  $(1/\text{time scale})$  seconds. A time coordinate system that has a time scale of 60 measures time in terms of sixtieths of a second.

**time value** A value that specifies a number of time units in a time coordinate system. A time value may contain information about a point in time or about a duration.

**track** A Movie Toolbox data structure that represents a single data stream in a QuickTime movie. A movie may contain one or more tracks. Each track is independent of other tracks in the movie and represents its own data stream. Each track has a corresponding media, which describes the data for the track.

**track boundary region** A region that describes the area occupied by a track in the track's coordinate system. QuickTime obtains this region by applying the track clipping region and the track matte to the visual image contained in the track rectangle.

**track clipping region** The clipping region of a track in the track's coordinate system. QuickTime applies the track's clipping region and the track matte to the image contained in the track rectangle to obtain the track boundary region. Only that portion of the track that lies in the track boundary region is then transformed into an image in the movie coordinate system.

**track header atom** A QT atom that specifies the characteristics of a track in a QuickTime movie.

**track height** The height, in pixels, of the track rectangle.

**track input map** A structure of QT atoms that specifies how secondary data for a track is to be interpreted (clipping, blending, etc.).

**track load settings** Information that specifies how and when a track is to be preloaded before running in a movie.

**track matte** A pixel map that defines the blending of track visual data. The value of each pixel in the pixel map governs the relative intensity of the track data for the corresponding pixel in the result image. QuickTime applies the track matte, along with the track clipping region, to the image contained in the track rectangle to obtain the track boundary region. See [track matte](#), [track rectangle](#), and [track boundary region](#).

**track movie boundary region** A region that describes the area occupied by a track in the movie coordinate system, before the movie has been clipped by the movie clipping region. The movie boundary region is built up from the track movie boundary regions for each of the movie's tracks.

**track offset** The blank space that represents the intervening time between the beginning of a movie and the beginning of a track's data. In an audio track, the blank space translates to silence; in a video track, the blank space generates no visual image. All of the tracks in a movie use the movie's time coordinate system. That is, the movie's time scale defines the basic time unit for each of the movie's tracks. Each track begins at the beginning of the movie, but the track's data might not begin until some time value other than 0.

**track reference** A data structure that defines the relation between movie tracks, such as the relation between a timecode track and other tracks. See [timecode track](#).

**track rectangle** A rectangle that completely encloses the visual representation of a track in a QuickTime movie. The width of this rectangle in pixels is referred to as the track width; the height, as the track height.

**track width** The width, in pixels, of the track rectangle.

**transformation matrix** A 3-by-3 matrix that defines how to map points from one coordinate space into another coordinate space.

**tween data** The data in a tween track, such as interpolation values.

**tween track** A modifier track that performs a specific kind of tweening, such as path-to-matrix rotation.

**tweening** A process interpolating new data between given values in conformance to an algorithm. It is an efficient way to expand or smooth a movie's presentation between its actual frames.

**twos-complement encoding** A system for digitally encoding sound that stores the amplitude values as a signed number—silence is represented by a sample with a value of 0. For example, with 8-bit sound samples, twos-complement values would range from -128 to 127, with 0 meaning silence. The Audio Interchange File Format (AIFF) stores samples in twos-complement form. Compare [offset-binary encoding](#).

**URL** The address of a website.

**user data** Auxiliary data that your application can store in a QuickTime movie, track, or media structure. The user data is stored in a user data list; items in the list are referred to as user data items. Examples of user data include a copyright, date of creation, name of a movie's director, and special hardware and software requirements. See also [user data list](#), [user data item](#)

**user data item** A single element in a user data list, such as a modification date or copyright notice.

**user data list** The collection of user data for a QuickTime movie, track, or media. Each element in the user data list is called a user data item.

**VR (virtual reality)** See QuickTime VR.

**Wired Sprite** A sprite such as a clickable button that has wired actions associated with it.